

AIR CONDITIONER

Duct type

SERVICE MANUAL

INDOOR



ARXG45KHTB
ARXG54KHTB

OUTDOOR



AOYG45KRTA
AOYG54KRTA

Notices:

- Product specifications and design are subject to change without notice for future improvement.
- For further details, please check with our authorized dealer.

Trademarks

FGLair™ is trademark of Fujitsu General Limited in the United States, other countries or both.

Google Play™ is trademark of Google LLC.

App Store® is a service mark of Apple Inc., registered in the U.S. and other countries.

CONTENTS

1. GENERAL INFORMATION

2. TECHNICAL DATA AND PARTS LIST

3. TROUBLESHOOTING

4. CONTROL AND FUNCTIONS

5. FIELD WORKING

1. GENERAL INFORMATION

CONTENTS

1. GENERAL INFORMATION

1. Specifications	01-1
1-1. Indoor unit	01-1
1-2. Outdoor unit.....	01-2
2. Dimensions	01-3
2-1. Indoor unit	01-3
2-2. Outdoor unit.....	01-5

1. Specifications

1-1. Indoor unit

Type				Duct		
				Inverter heat pump		
Model name				ARXG45KHTB	ARXG54KHTB	
Power supply				3N 400 V ~ 50 Hz		
Power supply intake				Outdoor unit		
Available voltage range				342—457 V		
Capacity	Cooling	Rated	kW	12.1	13.4	
			Btu/h	41,300	45,700	
		Min.—Max.	kW	4.0—14.0	5.0—14.5	
	Heating	Rated	Btu/h	13,600—47,800	17,100—49,400	
			kW	13.5	15.5	
		Min.—Max.	Btu/h	46,100	52,900	
			kW	5.0—16.2	5.5—18.0	
			Btu/h	17,100—55,300	18,800—61,400	
Input power	Cooling	Rated	kW	4.16	4.77	
		Max.		5.22	5.59	
	Heating	Rated		3.61	4.18	
		Max.		5.07	5.67	
Current	Cooling	Rated	A	7.6	8.5	
	Heating	Rated		6.8	7.6	
Power factor	Cooling		%	79.4	81.7	
	Heating			77.4	79.5	
EER	Cooling		kW/kW	2.91	2.81	
COP	Heating			3.74	3.71	
Moisture removal			L/h (pints/h)	1.5 (2.6)	2.0 (3.5)	
Maximum operating current*1		Cooling	A	14		
		Heating		14		
Fan	Airflow rate	Cooling	HIGH	m ³ /h	3,350	
			MED		2,850	
			LOW		2,430	
		Heating	HIGH		3,350	
			MED		2,850	
			LOW		2,430	
	Type × Q'ty		Sirocco fan × 2			
	Motor output		W	490		
Static pressure range			Pa	100 to 250		
Sound pressure level ²	Cooling	HIGH	dB (A)	47		
		MED		43		
		LOW		40		
	Heating	HIGH		47		
		MED		43		
		LOW		40		
Heat exchanger type	Dimensions (H × W × D)		mm	336 × 890 × 53.2		
	Fin pitch			1.3		
	Rows × Stages			4 × 16		
	Pipe type			Copper		
	Fin type			Aluminum		
Enclosure		Material		Steel sheet		
Dimensions (H × W × D)		Color		—		
		Net	mm	400 × 1,050 × 500		
		Gross		460 × 1,230 × 640		
Weight		Net	kg	46		
		Gross		51		
Connection pipe	Size	Liquid	mm (in)	Ø9.52 (3/8)		
		Gas		Ø15.88 (5/8)		
	Method			Flare		
Operation range	Cooling	°C	18 to 32			
		%RH	80 or less			
	Heating	°C	16 to 30			
Drain port	Material		Steel			
	Size	mm	Ø23.4 (I.D.), Ø25.4 (O.D.)			
Remote control (Option)			Wired remote controller, Wireless remote controller, Simple remote controller, IR Receiver Unit, Mobile app ³ (FGLair™)			
NOTES:						
<ul style="list-style-type: none"> Specifications are based on the following conditions: <ul style="list-style-type: none"> Cooling: Indoor temperature of 27 °CDB/19 °CWB, and outdoor temperature of 35 °CDB/24 °CWB. Heating: Indoor temperature of 20 °CDB/15 °CWB, and outdoor temperature of 7 °CDB/6 °CWB. Pipe length: 5 m, Height difference: 0 m. (Between outdoor unit and indoor unit.) Standard static pressure: 100 Pa Protective function might work when using it outside the operation range. *1: Maximum operating current is the total current of the indoor unit and the outdoor unit. *2: Sound pressure level: <ul style="list-style-type: none"> Measured values in manufacturer's anechoic chamber. Because of the surrounding sound environment, the sound levels measured in actual installation conditions might be higher than the specified values here. *3: Available on Google Play™ store or on App Store®. Optional WLAN Adapter is also required. For details, refer to the setting manual. 						

1-2. Outdoor unit

Type			Inverter heat pump			
Model name			AOYG45KRTA		AOYG54KRTA	
Power supply			3N 400 V ~ 50 Hz			
Power supply intake			Outdoor unit			
Available voltage range			342—457 V			
Starting current			7.6		8.5	
Fan	Airflow rate	Cooling	4,450			
		Heating	4,450			
	Type × Qty	Propeller × 1				
	Motor output	W	120			
Sound pressure level *1	Cooling	dB (A)	57			
	Heating		57		59	
Sound power level	Cooling	dB (A)	71			
	Heating		71		73	
Heat exchanger type	Dimensions (H × W × D)	mm	Main1: 966 × 905 × 18.20 Main2: 966 × 905 × 18.20 Sub: 966 × 543 × 18.20			
	Fin pitch		Main1: 1.45 Main2: 1.45 Sub: 1.45			
	Rows × Stages		Main1: 1 × 46 Main2: 1 × 46 Sub: 1 × 46			
	Pipe type		Copper			
	Fin		Type (Material)	Aluminum		
			Surface treatment	Blue fin		
Compressor	Type	W	DC Twin rotary			
	Motor output		2,180			
Refrigerant	Type (Global warming potential)	R32 (675)				
	Factory charge	g	2,700			
Refrigerant oil	Type	RmM68AF				
	Amount	cm ³	800			
Enclosure	Material	Steel sheet				
	Color	Beige Approximate color of Munsell 10YR 7.5/1.0				
Dimensions (H × W × D)	Net	mm	998 × 940 × 320			
	Gross		1,176 × 1,027 × 445			
Weight	Net	kg	67			
	Gross		77			
Connection pipe	Size	Liquid	Ø 9.52 (3/8)			
		Gas	Ø 15.88 (5/8)			
	Method	Flare				
	Pre-charge length	m	30			
	Max. length		50			
Max. height difference	30					
Operation range	Cooling	°C	-15 to 46			
	Heating		-15 to 24			
Drain hose	Material	LDPE				
	Tip diameter	mm	Ø 13.0 (I. D.), Ø 16.0 to Ø 16.7 (O. D.)			

NOTES:

- Specifications are based on the following conditions:
 - Cooling: Indoor temperature of 27 °CDB/19 °CWB, and outdoor temperature of 35 °CDB/24 °CWB.
 - Heating: Indoor temperature of 20 °CDB/15 °CWB, and outdoor temperature of 7 °CDB/6 °CWB.
 - Pipe length: 5.0 m, Height difference: 0 m. (Between outdoor unit and indoor unit.)
- Protective function might work when using it outside the operation range.
- *1: Sound pressure level
 - Measured values in manufacturer's anechoic chamber.
 - Because of the surrounding sound environment, the sound levels measured in actual installation conditions might be higher than the specified values here.
- This data is based on EN 14511 standard.

2. Dimensions

2-1. Indoor unit

■ Models: ARXG45KHTB and ARXG54KHTB

Unit: mm

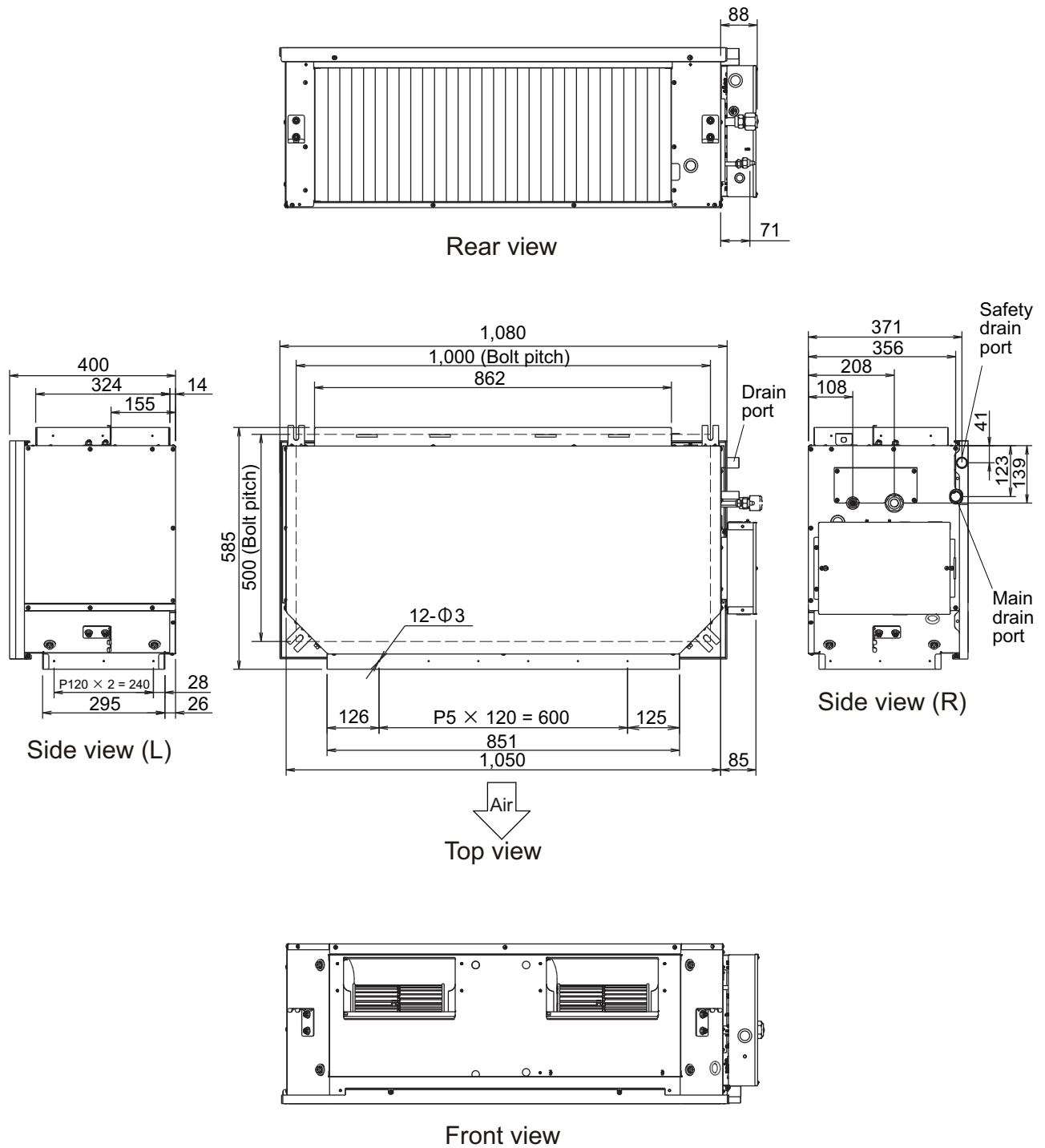

■ Installation space requirement

Provide sufficient installation space for product safety.

NOTE: The detailed component shape depends on the model.

● Models: ARXG45KHTB and ARXG54KHTB

Installation by which maintenance space is made on top of the unit (recommended).

Unit: mm

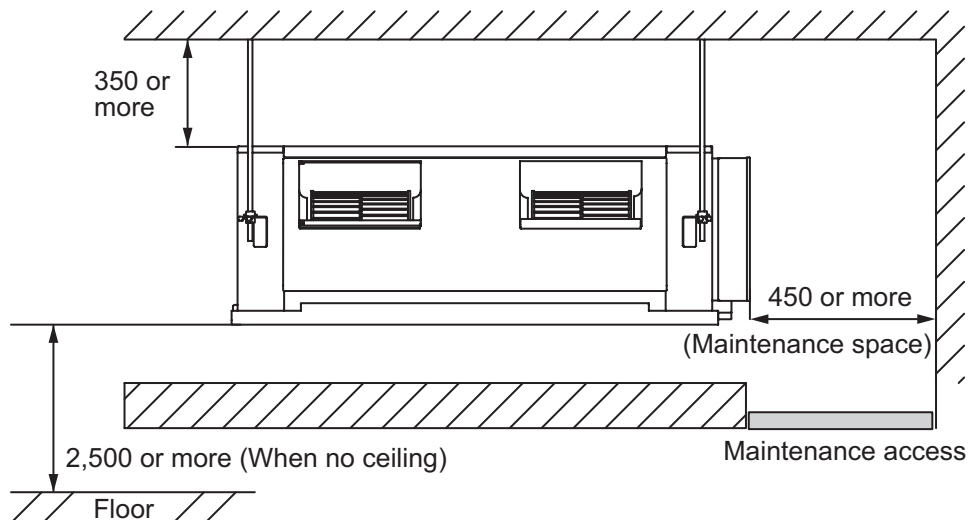

Installation by which maintenance space is carried out from the bottom of the unit.

Unit: mm

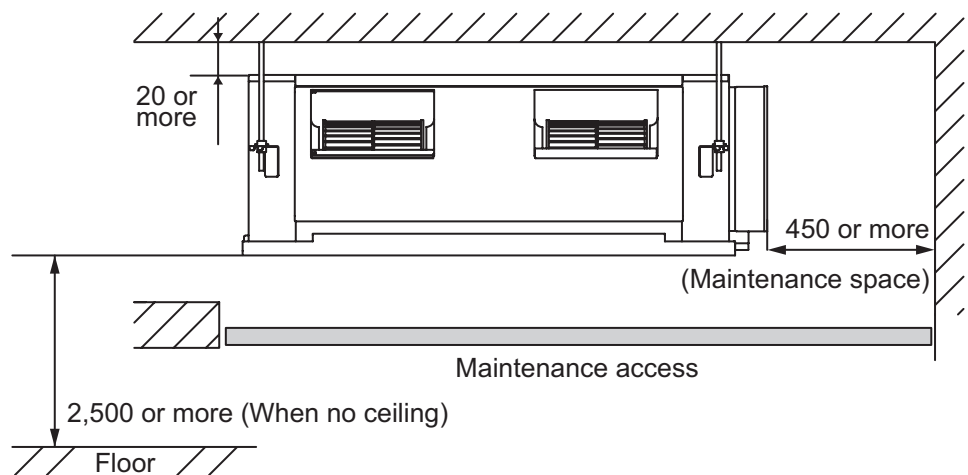

2-2. Outdoor unit

Models: AOYG45KRTA and AOYG54KRTA

Unit: mm

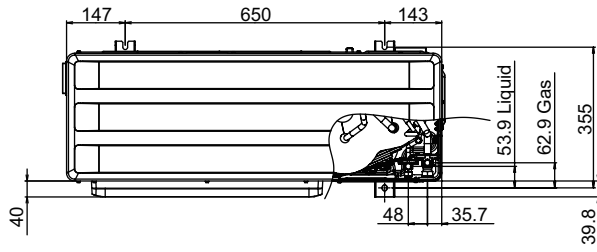

Top view

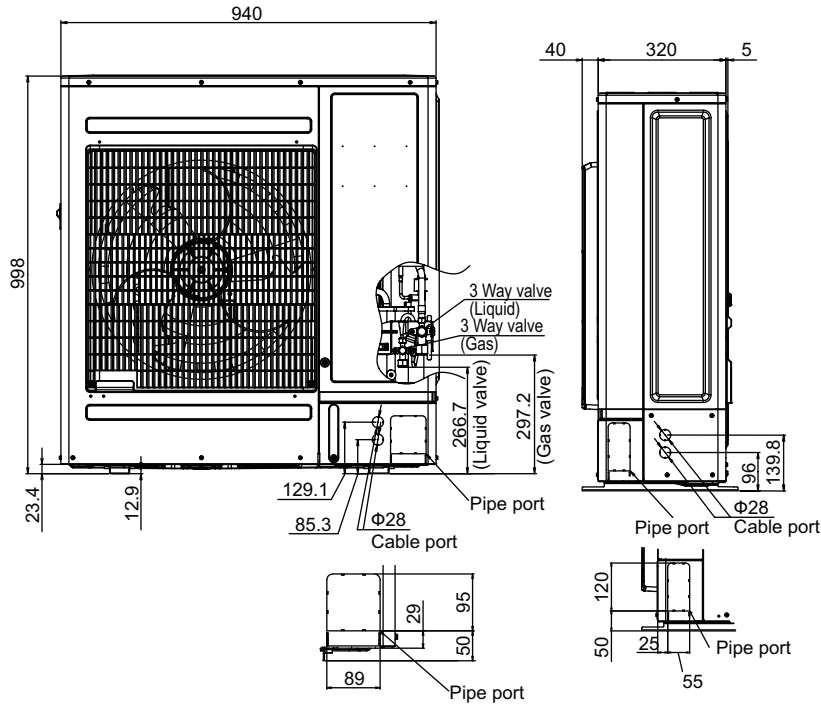

Front view

Side view

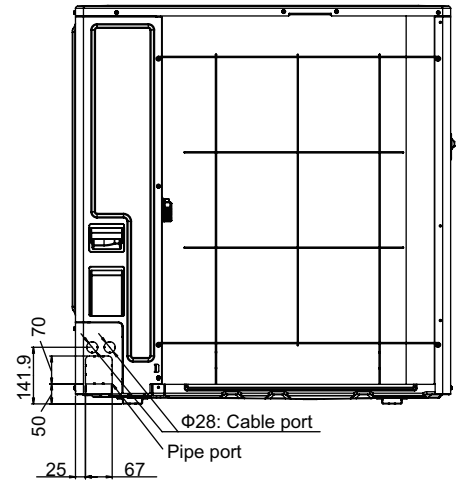

Rear view

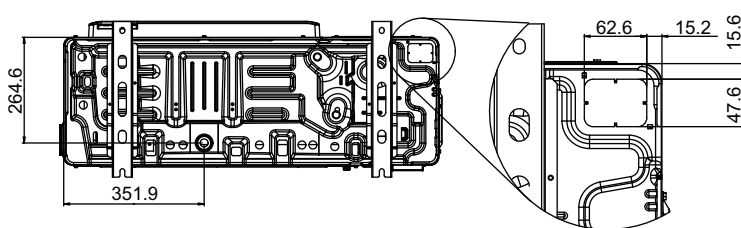

Bottom view

Pipe & Cable port

2. TECHNICAL DATA AND PARTS LIST

CONTENTS

2. TECHNICAL DATA AND PARTS LIST

1. Precautions	02-1
2. Indoor unit parts list	02-2
2-1. Models: ARXG45KHTB and ARXG54KHTB.....	02-2
3. Outdoor unit parts list	02-6
3-1. Models: AOYG45KRTA and AOYG54KRTA	02-6
4. Accessories	02-10
4-1. Indoor unit	02-10
4-2. Outdoor unit.....	02-10
5. Optional parts	02-11
5-1. Indoor unit	02-11
5-2. Outdoor unit.....	02-13
6. Refrigerant system diagrams	02-14
6-1. Models: AOYG45KRTA and AOYG54KRTA	02-14
7. Wiring diagrams	02-15
7-1. Indoor unit	02-15
7-2. Outdoor unit.....	02-16
8. PC board diagrams	02-17
8-1. Models: ARXG45KHTB and ARXG54KHTB.....	02-17
8-2. Models: AOYG45KRTA and AOYG54KRTA	02-18

1. Precautions

When you start servicing, pay attention to the following points. For detailed precautions, refer to the installation manual of the products.

⚠ CAUTION

- Service personnel
 - Any person who is involved with working on or breaking into a refrigerant circuit should hold a current valid certificate from an industry-accredited assessment authority, which authorizes their competence to handle refrigerants safely in accordance with an industry recognized assessment specification.
 - Servicing shall only be performed as recommended by the equipment manufacturer. Maintenance and repair requiring the assistance of other skilled personnel shall be carried out under the supervision of the person competent in the use of flammable refrigerants.
 - Servicing shall be performed only as recommended by the manufacturer.
 - Work
 - Prior to beginning work on systems containing flammable refrigerants, safety checks are necessary to ensure that the risk of ignition is minimized. When repairing the refrigerant system, refer to the precautions written in the installation manual of the products before you start servicing.
 - Work shall be undertaken under a controlled procedure so as to minimize the risk of a flammable gas or vapor being present while the work is being performed.
 - All maintenance staff and others working in the local area shall be instructed on the nature of work being carried out.
 - Work in confined spaces shall be avoided.
 - The area around the workspace shall be sectioned off.
 - Ensure that the conditions within the area have been made safe by control of flammable material.
 - Electric shock may occur. After turning off the power, always wait 5 minutes before touching electrical components.
 - Do not touch the fins of the heat exchanger. Touching the heat exchanger fins could result in damage to the fins or personal injury such as skin rupture.
 - Do not place any other electrical products or household belongings under the product.
 - Condensation dripping from the product might get them wet, and may cause damage or malfunction to the property.
 - Checking for presence of refrigerant
 - The area shall be checked with an appropriate refrigerant leak detector prior to and during work, to ensure the technician is aware of potentially flammable atmospheres.
 - Ensure that the leak detector being used is suitable for use with flammable refrigerants, i.e. non-sparking, adequately sealed or intrinsically safe.
-
- Service parts information and design are subject to change without notice for product improvement.
 - For the latest information of the service parts, refer to our Service Portal.
<https://fujitsu-general.force.com/portal/>
 - Precise figure of the service parts listed in this manual may differ from the actual service parts.

2. Indoor unit parts list

2-1. Models: ARXG45KHTB and ARXG54KHTB

■ Casing and fan

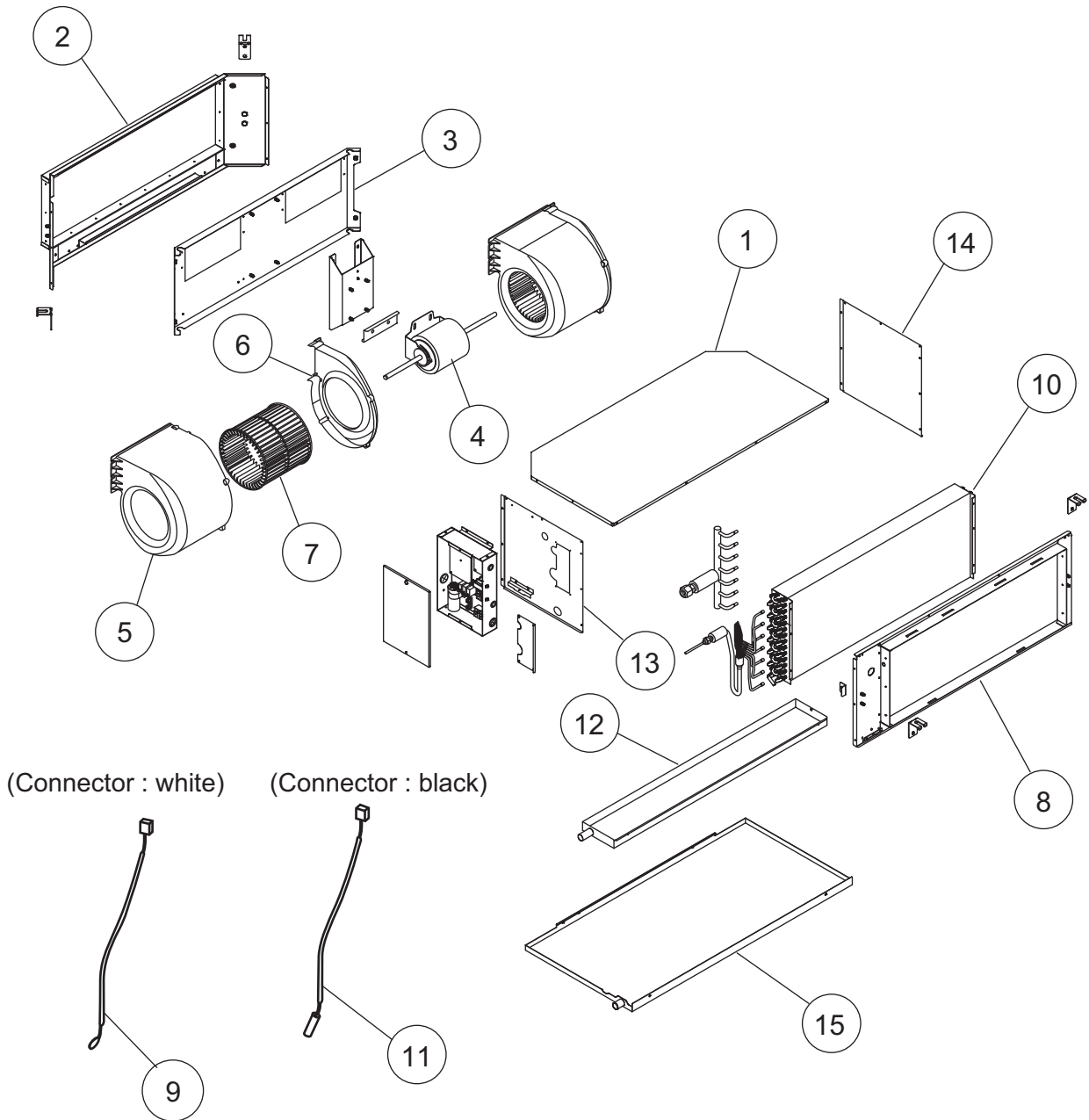

TECHNICAL DATA
AND PARTS LIST

TECHNICAL DATA
AND PARTS LIST

Item no.	Part no.	Part name	Service part
1	9372576014	Plate Top Sub Assy	◆
2	9372637029	Kit (Panel Front Sub Assy)	◆
3	9372035009	Panel Fan Assy	◆
4	9602802012	Motor, Induct	◆
5	9372057018	Casing A	◆
6	9372058015	Casing B	◆
7	9372059029	Sirocco Fan	◆
8	9372636022	Kit (Panel Rear Sub Assy)	◆
9	9900826086	Room Thermistor	◆
10	9372584248	Evaporator Sub Assy	◆
11	9901075032	Pipe Thermistor	◆
12	9372579015	Drain Pan Assy	◆
13	9372916025	Kit (Panel Right Sub Assy)	◆
14	9372581018	Kit (Panel Left Sub Assy)	◆
15	9372582015	Drain Pan S Sub Assy	◆

■ Main PC board

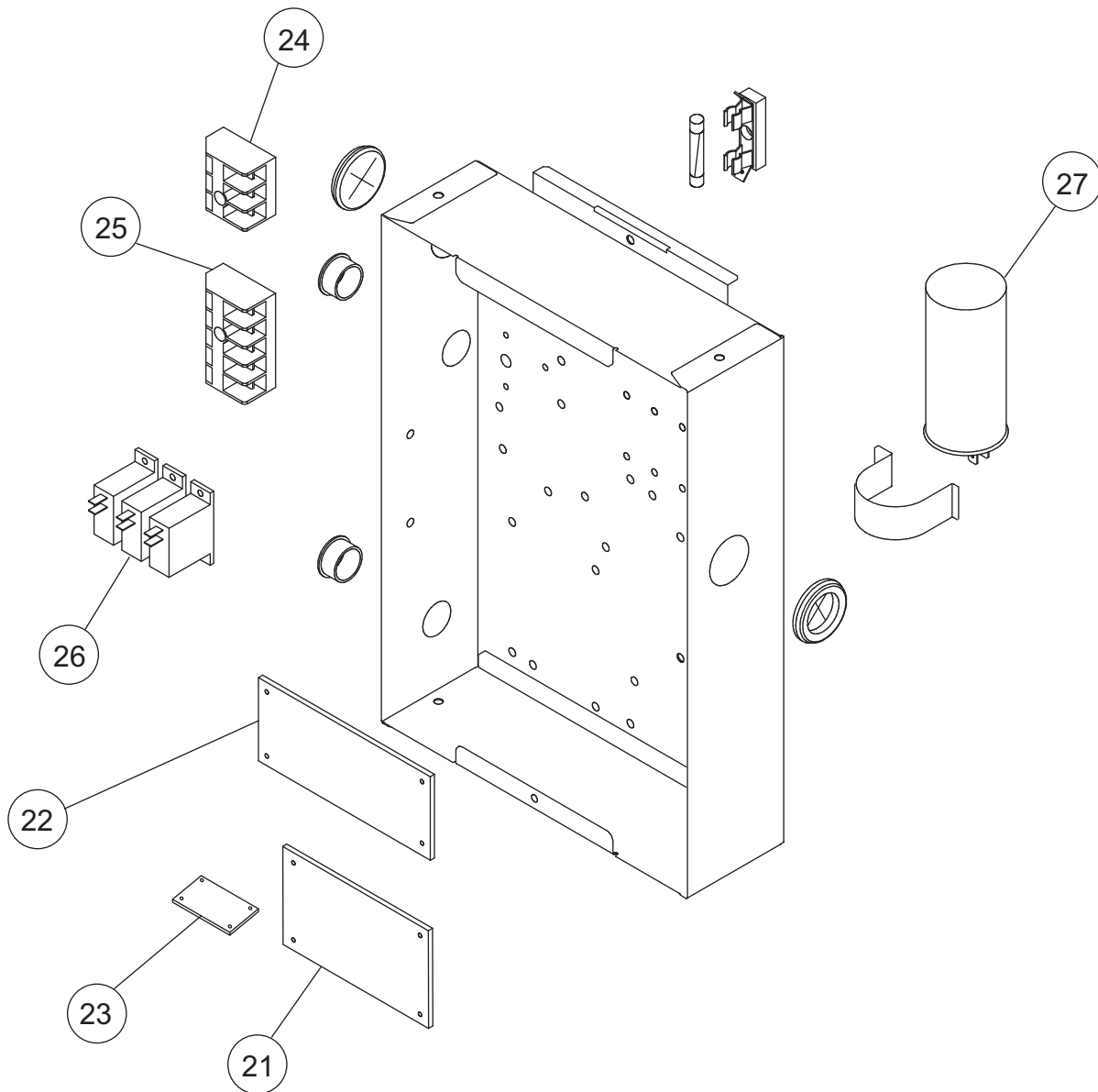

TECHNICAL DATA
AND PARTS LIST

TECHNICAL DATA
AND PARTS LIST

Item no.	Part no.	Part name	Service part
21	9710661082	Power supply PCB	◆
22	9711870223	Main PCB (45)	◆
22	9711870230	Main PCB (54)	◆
23	9710019005	Communication PCB	◆
24	9306489045	Terminal 3P	◆
25	9900896027	Terminal 5P	◆
26	9900294014	Relay	◆
27	9900269111	Capacitor, Plastic	◆
-	9710343124	Wire with connector (CN300 on Main PCB—Terminal)	◆
-	9710177118	Wire with connector (CN46 on Main PCB—Terminal)	◆
-	9710703027	Wire with connector (CN205 on Power supply PCB—Terminal (AC power))	◆
-	9712115002	Wire assy (CN12 on Main PCB—Relay (Sec))	◆
-	9710171093	Wire with connector (CN54 on Main PCB—CN264 on Power supply PCB)	◆
-	9710172014	Wire with connector (CN55 on Main PCB—CN263 on Power supply PCB)	◆

3. Outdoor unit parts list

3-1. Models: AOYG45KRTA and AOYG54KRTA

■ Exterior parts and chassis

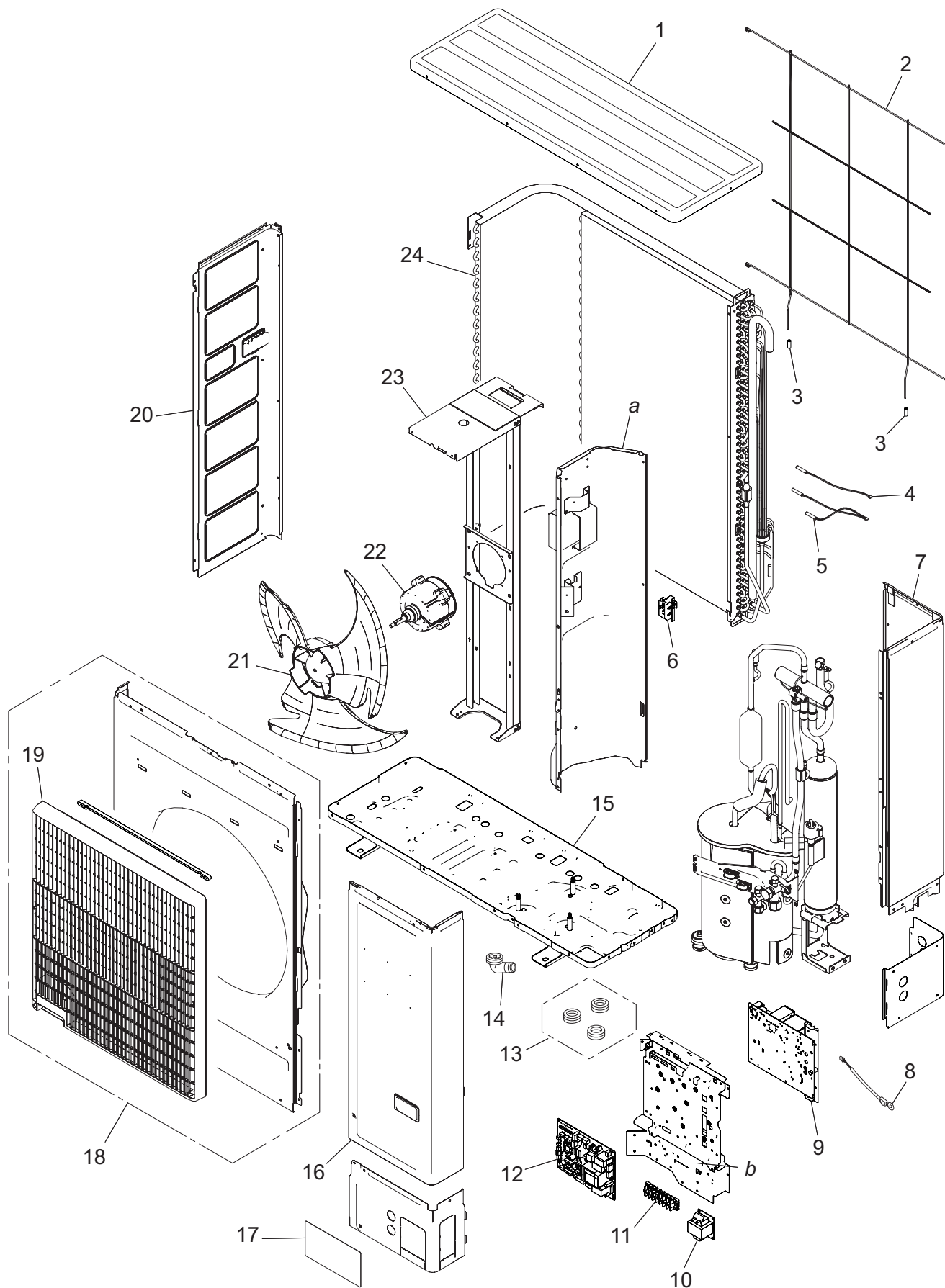

TECHNICAL DATA
AND PARTS LIST

TECHNICAL DATA
AND PARTS LIST

Item no.	Part no.	Part name	Service part
1	9383880001	Top panel assy	◆
2	9381013005	Protective net	◆
3	9375361013	Net rubber	◆
4	9900984038	Thermistor (Heat exchanger)	◆
5	9900727154	Thermistor assy	◆
6	9383607004	Thermo holder	◆
7	9383874017	Right panel sub assy	◆
8	9901031014	Heatsink thermistor	◆
9	9709684146	Inverter PCB	◆
10	9900634025	Reactor assy	◆
11	9901053016	Terminal	◆
12	9711431714	Main PCB (Service) (for 45 model)	◆
	9711431721	Main PCB (Service) (for 54 model)	◆
13	313166024302	Drain cap	◆
14	9303029015	Drain assy	◆
15	9350255009	Base assy (Service)	◆
16	9383876011	Service panel sub assy	◆
17	9380114000	Emblem rear	◆
18	9383863011	Front panel assy	◆
19	9383604003	Blow grille	◆
20	9383882012	Left panel sub assy	◆
21	9383336003	Propeller fan	◆
22	9603733018	Brushless motor	◆
23	9383862014	Motor bracket assy	◆
24	9374420605	Condenser sub assy	◆
—	9711198020	Wire with connector (P108 on Main PCB—Terminal)	◆
—	9711445001	Wire with connector (P104-106 on Main PCB—W200-202 on Inverter PCB)	◆
—	9711446008	Wire with terminal (P203-204 on Inverter PCB—Reactor)	◆
—	9711203007	Wire with connector (P660 on Main PCB—P662 on Inverter PCB)	◆
—	9711204004	Wire with connector (P661 on Main PCB—P663 on Inverter PCB)	◆
—	9711447012	Wire with terminal (P400-402 on Inverter PCB—Compressor)	◆
—	9711212009	Wire with connector (P650 on Inverter PCB—Fan motor)	◆
—	9711213006	Wire with connector (P770 on Inverter PCB—Wire with connector [to Pressure switch])	◆
—	9711214003	Wire with connector (Pressure switch—Wire with connector [to Inverter PCB])	◆
<i>a</i>	—	Separate wall assy	—
<i>b</i>	—	Control box unit	—

Compressor

TECHNICAL DATA
AND PARTS LIST

TECHNICAL DATA
AND PARTS LIST

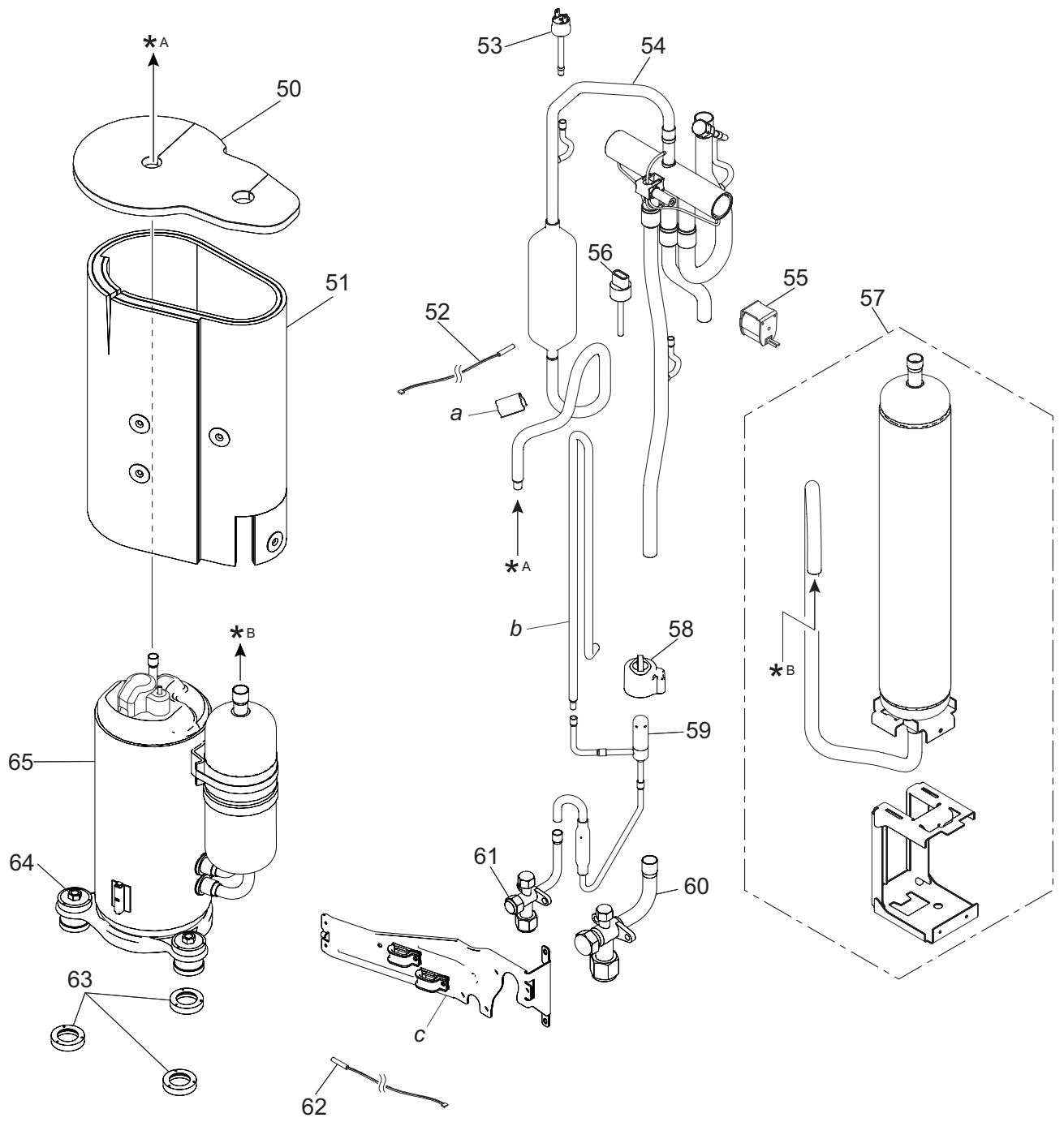





Item no.	Part no.	Part name	Service part
50	9380516019	S-ABS (top)	◆
51	9379647168	S-ABS (body)	◆
52	9900565091	Thermistor (Outdoor temp.)	◆
53	9900186029	Pressure switch	◆
54	9374425624	4-way valve assy	◆
55	9970194016	Solenoid	◆
56	9970158018	Sensor	◆
57	9384848000	Accumulator assy (service)	◆
58	9970209000	Expansion valve coil	◆
59	9370947311	Expansion valve assy	◆
60	9379079013	3-way valve assy	◆
61	9377958037	3-way valve assy	◆
62	9900985028	Thermistor (Compressor)	◆
63	9379179089	Rubber washer F	◆
64	9377973016	Special nut	◆
65	9810626004	Compressor assy	◆
<i>a</i>	—	Thermostat holder	—
<i>b</i>	—	Joint pipe D	—
<i>c</i>	—	Wiring fixation unit	—

4. Accessories

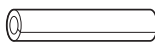
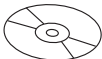

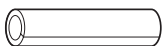

4-1. Indoor unit

■ Models: ARXG45KHTB and ARXG54KHTB

Part name	Exterior	Q'ty	Part name	Exterior	Q'ty
Operation manual		1	Coupler heat insulation (small)		1
Operation manual (CD-ROM)		1	Washer		8
Installation manual		1	Cable tie		1
Coupler heat insulation (large)		1			

4-2. Outdoor unit





■ Models: AOYG45KRTA and AOYG54KRTA

Part name	Exterior	Qty	Part name	Exterior	Qty
Installation manual		1	Drain cap		3
Drain pipe		1	One-touch bush		2

5. Optional parts

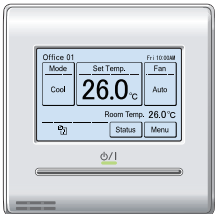
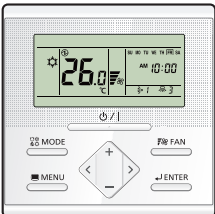
5-1. Indoor unit



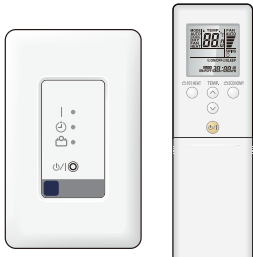

■ Controllers

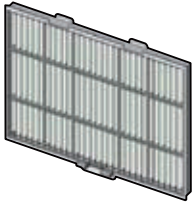
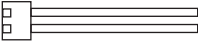
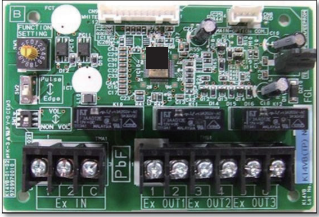
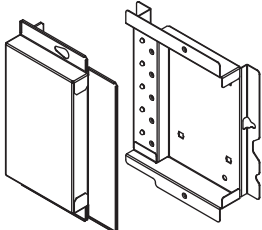

Exterior	Part name	Model name	Summary
	Wired Remote Controller	UTY-RNRYZ*	Easy finger touch operation with LCD panel. Backlit LCD enables easy operation in a dark room. Wire type: Non-polar 2-wire
	Wired Remote Controller	UTY-RLRY	High visibility and easy operation. Room temperature can be accurately controlled using the thermo sensor. Wire type: Non-polar 2-wire
	Compact Wired Remote Controller	UTY-RCRYZ1	Compact body and easy operation. Room temperature can be accurately controlled using the thermo sensor. Wire type: Non-polar 2-wire
	Simple Remote Controller	UTY-RSRY	Compact remote controller concentrates on the basic functions such as Start/Stop, fan control, temperature setting, and operation mode. Wire type: Non-polar 2-wire
	Simple Remote Controller	UTY-RHRY	Compact remote controller concentrates on the basic functions such as Start/Stop, fan control, and temperature setting. Wire type: Non-polar 2-wire
	IR Receiver Kit with Wireless Remote Controller	UTY-LBTYM	Unit control is performed by Wireless Remote Controller Connecting point: CN48 on Main PCB

NOTES:

- Available functions may differ by the remote controller. For details, refer to the operation manual.
- When using the group controlling system of the Wired Remote Controller, using WLAN Adapter is prohibited.

Others

Exterior	Part name	Model name	Summary
	Remote Sensor Unit	UTY-XSZX	Thermo-sensor for sensing the temperature of arbitrary place in the room.
	Long-life Filter	UTD-LF60KA	Long-life Filter can be mounted to the indoor unit.
	External Connect Kit	UTY-XWZXZG	Use to connect with various peripheral devices and air conditioner PCB. For control output port. Connecting point: CN47 on Main PCB
	External Input and Output PCB	UTY-XCSX	Use to connect with external devices and air conditioner PCB. Connecting point: CN65 or CN75 on Main PCB
	External Input and Output PCB Box	UTZ-GXEA	For installing the External input and output PCB.
	WLAN Adapter	UTY-TFSXZ1	Remotely manage an air conditioning system using mobile devices such as smartphones and tablets. For connection indoor unit with UART interface. Appropriate application for each region is required to use this option. For details, contact FGL sales company. Connecting point: CN75 on Main PCB
	Modbus Converter	UTY-VMSX	For connection between indoor unit with UART interface and a Modbus open network. Connecting point: CN65 or CN75 on Main PCB
	KNX Converter	UTY-VKSX	For connection between indoor unit with UART interface and a KNX open network. Connecting point: CN65 or CN75 on Main PCB
	Network Converter	UTY-VTGX	This converter is required when connecting single split system to VRF network system. Connecting point: CN65 or CN75 on Main PCB

Exterior	Part name	Model name	Summary
	Network Converter (AC power supply)	UTY-VTGXV	This converter is required when connecting single split system to VRF network system. Connecting point: CN65 or CN75 on Main PCB
	External Switch Controller	UTY-TERX	Air conditioner switching can be controlled by connecting other external sensor switches. Use the terminal for wired remote controller.

5-2. Outdoor unit

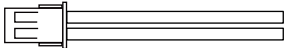
Exterior	Part name	Model name	Summary
	External Connect Kit	UTY-XWZXZ3	Use to operate the external input and output functions of outdoor unit.

6. Refrigerant system diagrams

6-1. Models: AOYG45KRTA and AOYG54KRTA

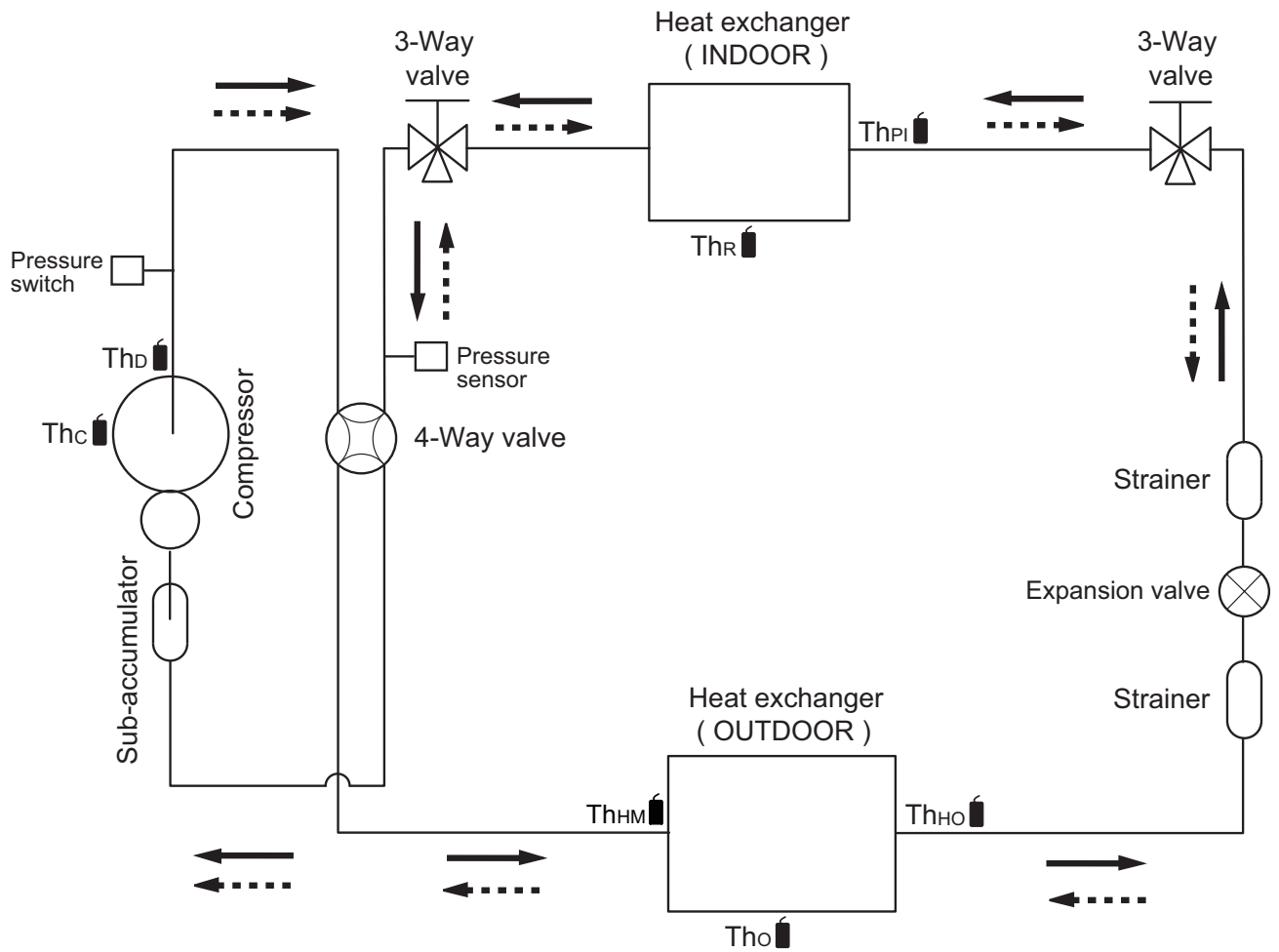

: Cooling
 : Heating

- Thc : Thermistor (Compressor temperature)
- ThD : Thermistor (Discharge temperature)
- ThHM : Thermistor (Heat Exchanger Med temperature)
- Tho : Thermistor (Outdoor temperature)
- ThHO : Thermistor (Heat Exchanger Out temperature)
- ThR : Thermistor (Room temperature)
- ThPI : Thermistor (Pipe temperature)

7. Wiring diagrams

7-1. Indoor unit

Models: ARXG45KHTB and ARXG54KHTB

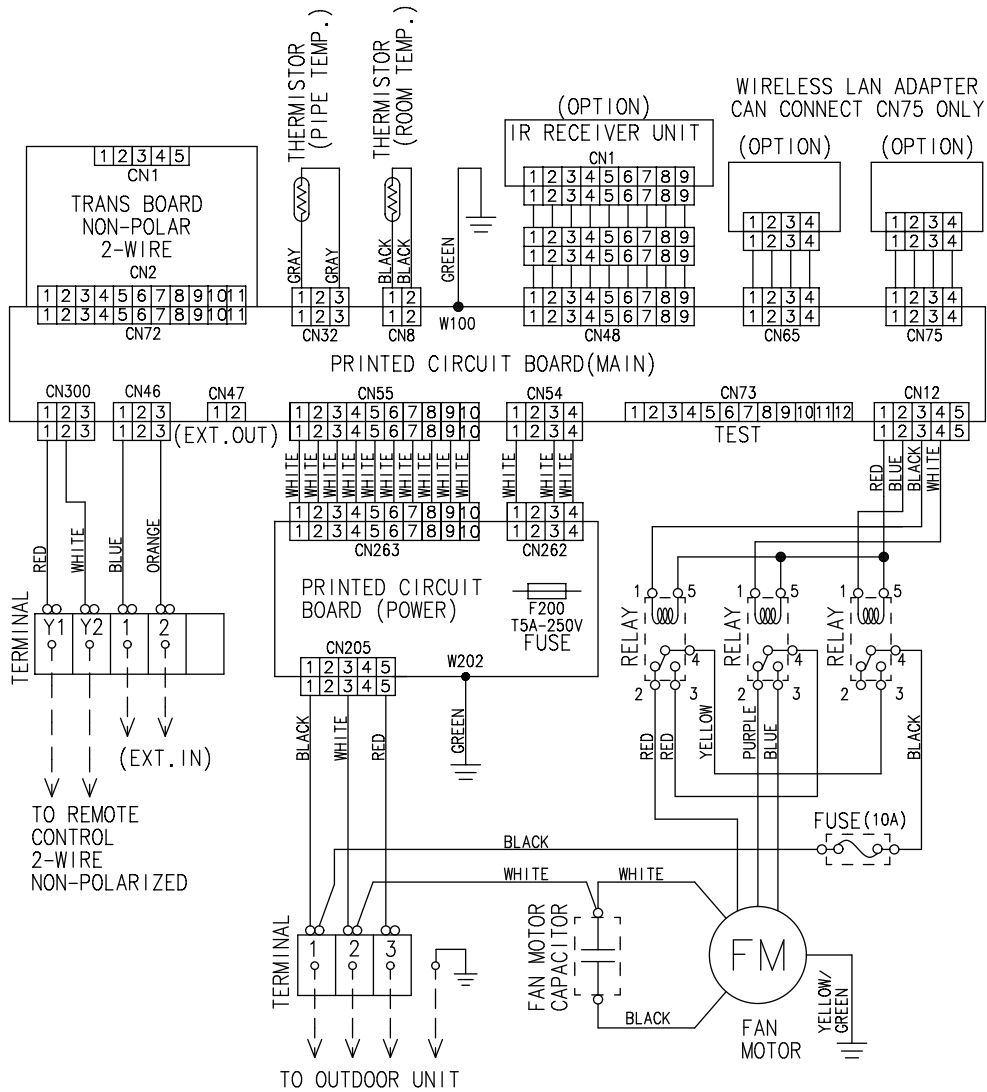

TECHNICAL DATA AND PARTS LIST

TECHNICAL DATA AND PARTS LIST

7-2. Outdoor unit

Models: AOYG45KRTA and AOYG54KRTA

TECHNICAL DATA
AND PARTS LIST

TECHNICAL DATA
AND PARTS LIST

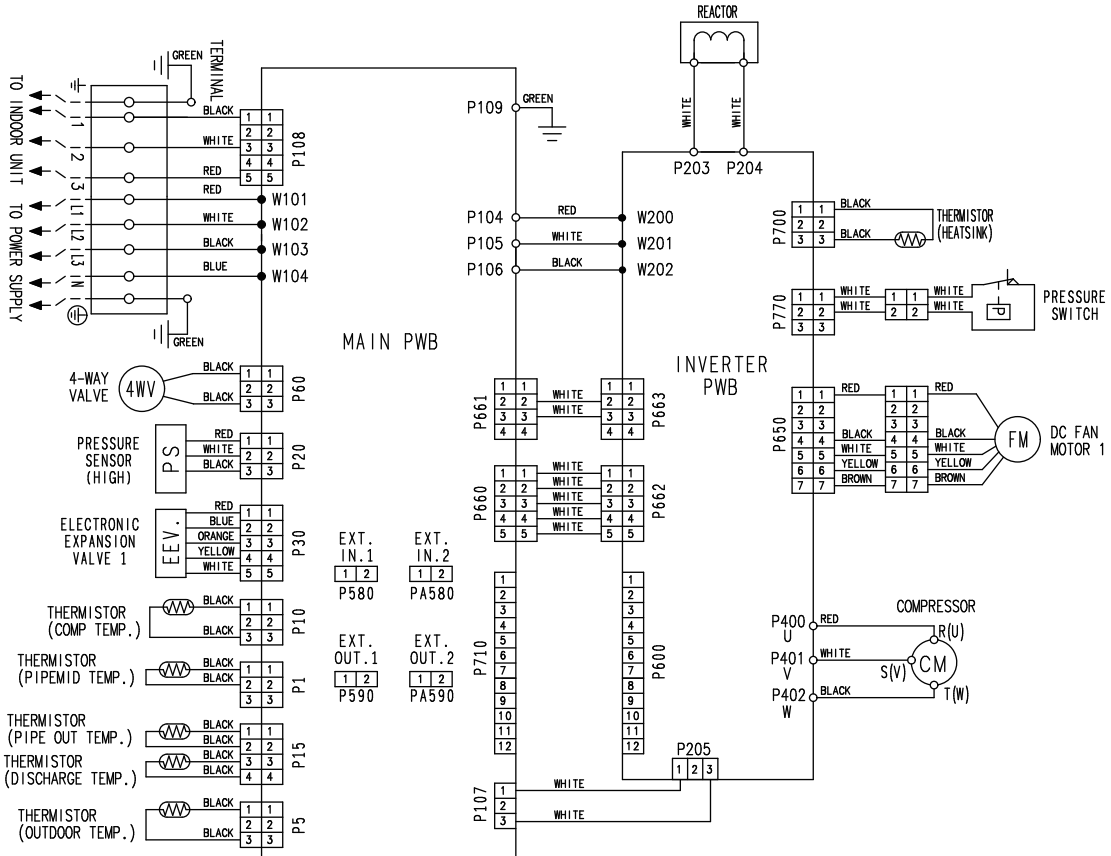

8. PC board diagrams

8-1. Models: ARXG45KHTB and ARXG54KHTB

TECHNICAL DATA AND PARTS LIST

TECHNICAL DATA AND PARTS LIST

CONTROL UNIT
45 model : EZ-0210DHSE
54 model : EZ-0210EHSE

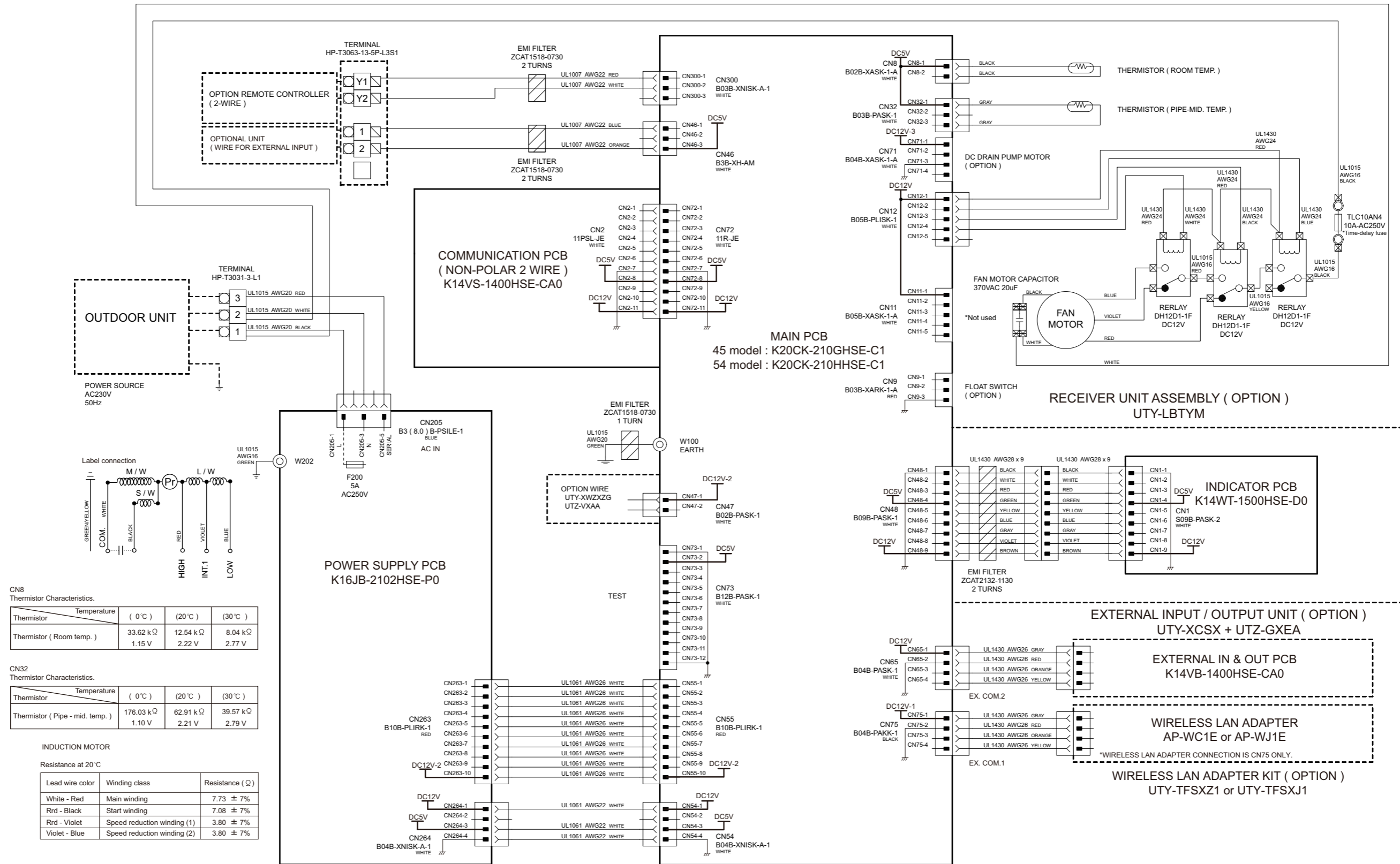

CN8 Thermistor Characteristics.

Thermistor	Temperature (0 °C)	(20 °C)	(30 °C)
Thermistor (Room temp.)	33.62 k Ω	12.54 k Ω	8.04 k Ω
	1.15 V	2.22 V	2.77 V

CN32 Thermistor Characteristics.

Thermistor	Temperature (0 °C)	(20 °C)	(30 °C)
Thermistor (Pipe - mid. temp.)	176.03 k Ω	62.91 k Ω	39.57 k Ω
	1.10 V	2.21 V	2.79 V

INDUCTION MOTOR

Resistance at 20 °C

Lead wire color	Winding class	Resistance (Ω)
White - Red	Main winding	7.73 ± 7%
Rrd - Black	Start winding	7.08 ± 7%
Rrd - Violet	Speed reduction winding (1)	3.80 ± 7%
Violet - Blue	Speed reduction winding (2)	3.80 ± 7%

8-2. Models: AOYG45KRTA and AOYG54KRTA

TECHNICAL DATA AND PARTS LIST

TECHNICAL DATA AND PARTS LIST

INVERTER ASSEMBLY
 36 model : EZ-0190HUE
 45 model : EZ-0193HUE
 54 model : EZ-0191HUE

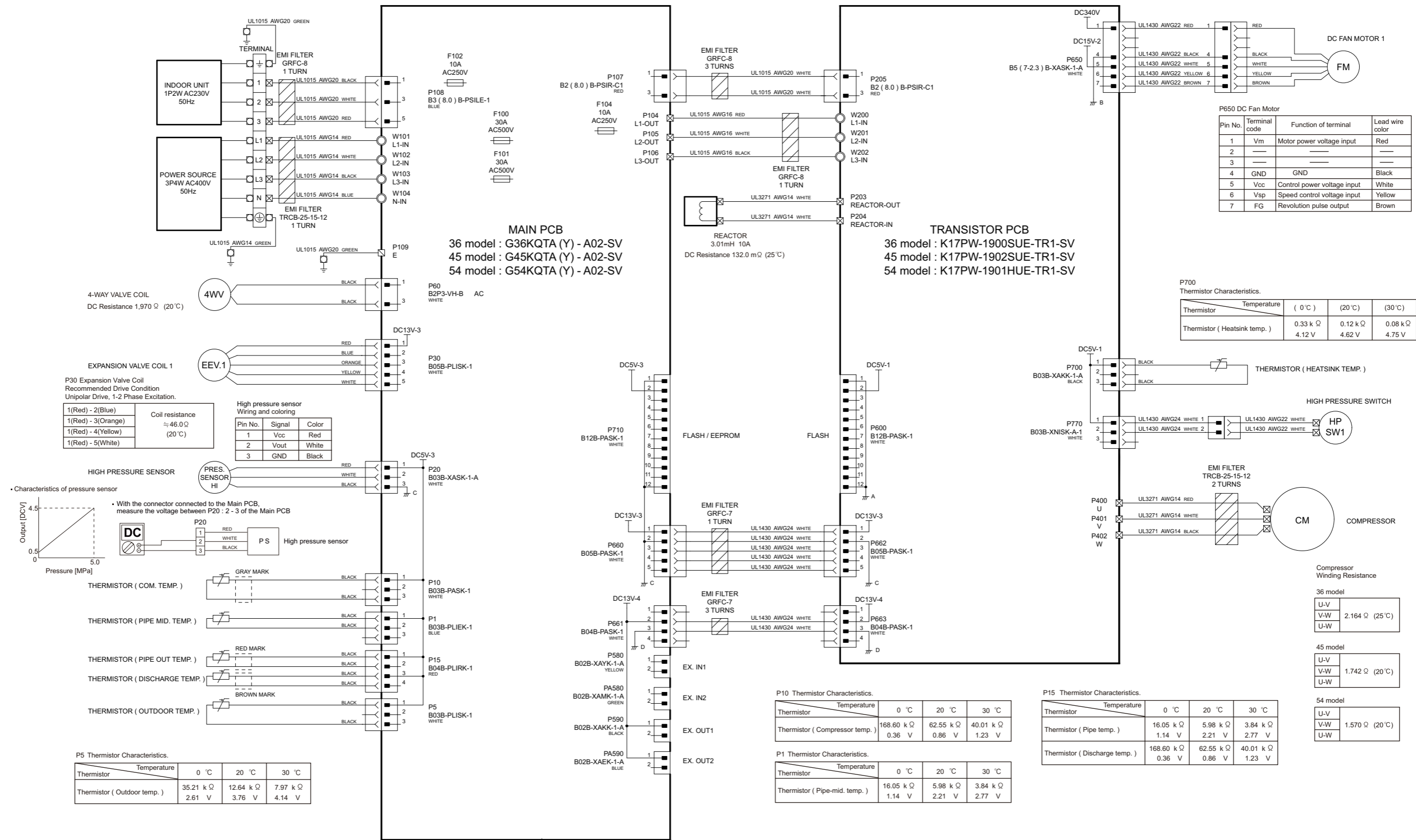

3. TROUBLESHOOTING

CONTENTS

3. TROUBLESHOOTING

1. Error code	03-1
1-1. How to check the error memory.....	03-1
1-2. How to erase the error memory	03-1
1-3. Error code table (Wired remote controller).....	03-2
1-4. Error code table (Outdoor unit).....	03-3
2. Troubleshooting with error code	03-5
2-1. E: 11. Serial communication error (Serial reverse transfer error) (Outdoor unit).....	03-5
2-2. E: 11. Serial communication error (Serial forward transfer error) (Indoor unit)	03-7
2-3. E: 12. Wired remote controller communication error (Indoor unit)	03-9
2-4. E: 23. Combination error (Outdoor unit).....	03-10
2-5. E: 32. Indoor unit main PCB error (Indoor unit)	03-11
2-6. E: 41. Room temperature sensor error (Indoor unit).....	03-12
2-7. E: 42. Indoor unit heat exchanger sensor error (Indoor unit)	03-13
2-8. E: 53. Drain pump error (Indoor unit).....	03-14
2-9. E: 62. Outdoor unit main PCB error (Outdoor unit).....	03-15
2-10. E: 63. Inverter error (Outdoor unit).....	03-16
2-11. E: 64. PFC circuit error (Outdoor unit)	03-17
2-12. E: 65. Trip terminal L error (Outdoor unit).....	03-18
2-13. E: 71. Discharge thermistor error (Outdoor unit).....	03-19
2-14. E: 72. Compressor thermistor error (Outdoor unit)	03-20
2-15. E: 73. Heat exchanger (Middle/Outlet) temperature thermistor error (Outdoor unit) ...	03-21
2-16. E: 74. Outdoor temperature thermistor error (Outdoor unit).....	03-22
2-17. E: 77. Heat sink thermistor error (Outdoor unit)	03-23
2-18. E: 84. Current sensor error (Outdoor unit)	03-24
2-19. E: 86. Pressure sensor error (Outdoor unit).....	03-25
2-20. E: 94. Trip detection (Outdoor unit).....	03-26
2-21. E: 95. Compressor motor control error (Outdoor unit)	03-27
2-22. E: 97. Outdoor unit fan motor error (Outdoor unit).....	03-28
2-23. E: 99. 4-way valve error (Outdoor unit).....	03-29
2-24. E: A1. Discharge temperature error (Outdoor unit).....	03-31
2-25. E: A3. Compressor temperature error (Outdoor unit)	03-33
2-26. E: AC. Heat sink temperature error (Outdoor unit)	03-35
3. Troubleshooting without error code.....	03-36
3-1. Indoor unit—No power.....	03-36
3-2. Outdoor unit—No power	03-37
3-3. No operation (Power is on).....	03-38
3-4. No cooling/No heating	03-39
3-5. Abnormal noise.....	03-41
3-6. Water leaking.....	03-42
4. Service parts information	03-43
4-1. Compressor.....	03-43

CONTENTS (continued)

4-2. Inverter compressor.....	03-44
4-3. Outdoor unit Electronic Expansion Valve (EEV)	03-45
4-4. Indoor unit fan motor	03-47
4-5. Outdoor unit fan motor	03-48
4-6. Pressure switch	03-49
4-7. 4-way valve coil (solenoid coil)/4-way valve	03-50
4-8. Discharge pressure sensor.....	03-51
5. Thermistor resistance values.....	03-52
5-1. Indoor unit	03-52
5-2. Outdoor unit.....	03-53

1. Error code

When a problem occurs in the system or the connected device, the error content is notified by displaying the code.

NOTE: This function is only available in a system with indoor or IR receiver units equipped with indicator lamps to show the error content.

Errors, once displayed, will be automatically stored in the PC board of the indoor unit. Even if the power is disconnected, the memory containing the error history will not be erased.

If another error occurs later, the stored error memory will be updated automatically and replaced with the new one. (Previous error will be erased.)

1-1. How to check the error memory

When an error occurs, the operation lamp (Green) and the timer lamp (Orange) indicate the error content by blinking. To check the error memory, follow the procedures below.

1. Stop the operation of the air conditioner, and then disconnect the power supply.
2. Reconnect the power supply.
3. In one of the following two methods, the memorized error is only displayed during the “3 minutes ST”^{*} state period.
 - Start the operation and then press the TEST RUN button on the remote controller.
 - Press the MANUAL AUTO button on the indoor unit for 10 seconds or more.

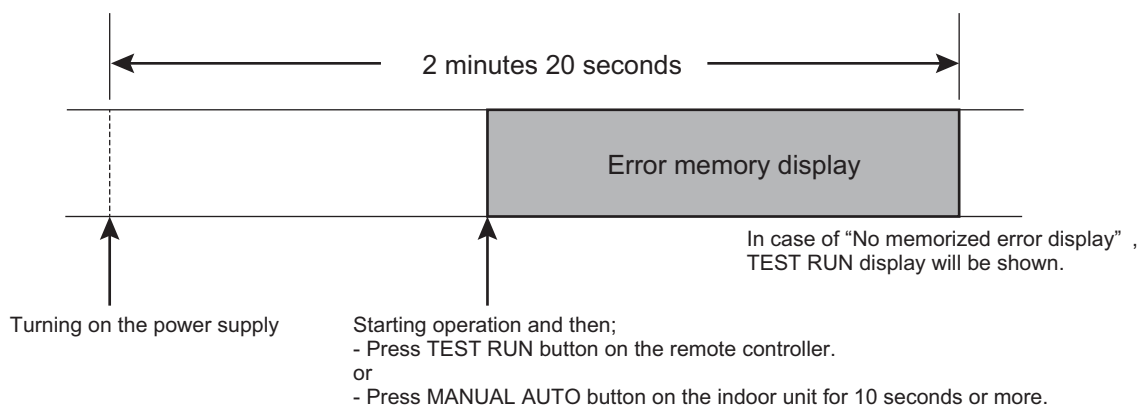

*: The “3 minutes ST” period lasts 2 minutes and 20 seconds after turning on the power supply.

1-2. How to erase the error memory

The error memory can be erased in one of the following two methods.

- Manual erase: Pressing the MANUAL AUTO button on the indoor unit while the “Error memory display” is being shown. (Short beep emits for about 3 seconds.)
- Automatic erase: After continuing the normal operation of the air conditioner without error for 2 hours or longer after displaying the error memory as described in [How to check the error memory](#). (Except FAN operation mode.)

1-3. Error code table (Wired remote controller)

The operation, timer, and economy indicators operate according to the error contents.
For confirmation of the error contents, refer the flashing pattern as follows.

Error contents	Wired remote controller display
E: 11. Serial communication error (Serial reverse transfer error) (Outdoor unit)	11
E: 11. Serial communication error (Serial forward transfer error) (Indoor unit)	11
E: 12. Wired remote controller communication error (Indoor unit)	12
E: 23. Combination error (Outdoor unit)	23
E: 32. Indoor unit main PCB error (Indoor unit)	32
E: 41. Room temperature sensor error (Indoor unit)	41
E: 42. Indoor unit heat exchanger sensor error (Indoor unit)	42
E: 53. Drain pump error (Indoor unit)	53
E: 62. Outdoor unit main PCB error (Outdoor unit)	62
E: 63. Inverter error (Outdoor unit)	63
E: 64. PFC circuit error (Outdoor unit)	64
E: 65. Trip terminal L error (Outdoor unit)	65
E: 71. Discharge thermistor error (Outdoor unit)	71
E: 72. Compressor thermistor error (Outdoor unit)	72
E: 73. Heat exchanger (Middle/Outlet) temperature thermistor error (Outdoor unit)	73
E: 74. Outdoor temperature thermistor error (Outdoor unit)	74
E: 77. Heat sink thermistor error (Outdoor unit)	77
E: 84. Current sensor error (Outdoor unit)	84
E: 86. Pressure sensor error (Outdoor unit)	86
E: 94. Trip detection (Outdoor unit)	94
E: 95. Compressor motor control error (Outdoor unit)	95
E: 97. Outdoor unit fan motor error (Outdoor unit)	97
E: 99. 4-way valve error (Outdoor unit)	99
E: A1. Discharge temperature error (Outdoor unit)	A1
E: A3. Compressor temperature error (Outdoor unit)	A3
E: AC. Heat sink temperature error (Outdoor unit)	AC

1-4. Error code table (Outdoor unit)

The operation status is determined by the lighting up and blinking of the LED lamp.
After check that ERROR LED lamp blinks, press the ENTER button once.

NOTE: For the positions of LED lamp and buttons, refer to "Function settings (For outdoor unit)" in Chapter 5. FIELD WORKING on page 05-7.

Error contents	POWER/ MODE	ERROR	PUMP DOWN	LOW NOISE		PEAK CUT		
			L1	L2	L3	L4	L5	L6
E: 11. Serial communication error (Serial forward transfer error) (Indoor unit) (Occurs immediately after starting operation)	■ 2	●	■ 1	■ 1	○	○	●	●
E: 11. Serial communication error (Serial forward transfer error) (Indoor unit) (Occurs during operation)	■ 2	●	■ 1	■ 1	○	●	○	○
E: 12. Wired remote controller communication error (Indoor unit)	■ 2	●	■ 5	■ 15	○	○	○	●
E: 23. Combination error (Outdoor unit)	■ 2	●	■ 5	■ 15	○	○	○	●
E: 32. Indoor unit main PCB error (Indoor unit)	■ 2	●	■ 5	■ 15	○	○	○	●
E: 41. Room temperature sensor error (Indoor unit)	■ 2	●	■ 5	■ 15	○	○	○	●
E: 42. Indoor unit heat exchanger sensor error (Indoor unit)	■ 2	●	■ 5	■ 15	○	○	○	●
E: 53. Drain pump error (Indoor unit)	■ 2	●	■ 5	■ 15	○	○	○	●
E: 62. Outdoor unit main PCB error (Outdoor unit)	■ 2	●	■ 6	■ 2	○	○	○	●
E: 63. Inverter error (Outdoor unit)	■ 2	●	■ 6	■ 3	○	○	○	●
E: 65. Trip terminal L error (Outdoor unit)	■ 2	●	■ 6	■ 5	○	○	●	●
E: 71. Discharge thermistor error (Outdoor unit)	■ 2	●	■ 7	■ 1	○	○	○	●
E: 72. Compressor thermistor error (Outdoor unit)	■ 2	●	■ 7	■ 2	○	○	○	●
E: 73. Heat exchanger (Middle/Outlet) temperature thermistor error (Outdoor unit)	■ 2	●	■ 7	■ 3	○	○	●	○
E: 74. Outdoor temperature thermistor error (Outdoor unit)	■ 2	●	■ 7	■ 4	○	○	○	●
E: 77. Heat sink thermistor error (Outdoor unit)	■ 2	●	■ 7	■ 7	○	○	○	●
E: 84. Current sensor error (Outdoor unit)	■ 2	●	■ 8	■ 4	○	○	○	●
E: 86. Pressure sensor error (Outdoor unit)	■ 2	●	■ 8	■ 6	○	●	●	○
E: 94. Trip detection (Outdoor unit)	■ 2	●	■ 9	■ 4	○	○	○	●
E: 95. Compressor motor control error (Outdoor unit)	■ 2	●	■ 9	■ 5	○	○	○	●
E: 97. Outdoor unit fan motor error (Outdoor unit)	■ 2	●	■ 9	■ 7	○	○	●	●
E: 99. 4-way valve error (Outdoor unit)	■ 2	●	■ 9	■ 9	○	○	○	●
E: A1. Discharge temperature error (Outdoor unit)	■ 2	●	■ 10	■ 1	○	○	○	●

Error contents	POWER/ MODE	ERROR	PUMP DOWN	LOW NOISE		PEAK CUT		
			L1	L2	L3	L4	L5	L6
E: A3. Compressor temperature error (Outdoor unit)	■ 2	●	■ 10	■ 3	○	○	○	●
E: AC. Heat sink temperature error (Outdoor unit)	■ 2	●	■ 10	■ 12	○	○	●	●

● : Light on ○ : Light off ■ (n) : n Times blinking

2. Troubleshooting with error code

2-1. E: 11. Serial communication error (Serial reverse transfer error) (Outdoor unit)

Indicator	Wired remote controller	Error code	E: 11
Detective actuator	Outdoor unit	Main PCB	When the indoor unit cannot receive the serial signal from outdoor unit more than 2 minutes after power on, or the indoor unit cannot receive the serial signal more than 15 seconds during normal operation.
		Fan motor	
Forecast of cause			Connection failure
			External cause
			Main PCB failure
			Outdoor unit fan motor failure

Check point 1. Reset the power and operate

Does error indication show again?

→ If no, go to "Check point 1-2".



Check point 2. Check connection

Check any loose or removed connection line of indoor unit and outdoor unit.

Check connection condition is control unit. (If there is loose connector, open cable or mis-wiring.)

→ If there is an abnormal condition, correct it by referring to the installation manual or the "DESIGN & TECHNICAL MANUAL".



Check point 3. Check the voltage of power supply

Check the voltage of power supply

Check if AC 198 V (AC 220 V -10%) to AC 264 V (AC 240 V +10%) appears at outdoor unit terminal L—N.

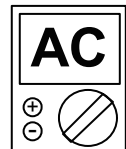

Check point 4. Check serial signal (Reverse transfer signal)

Check serial signal (Reverse transfer signal)

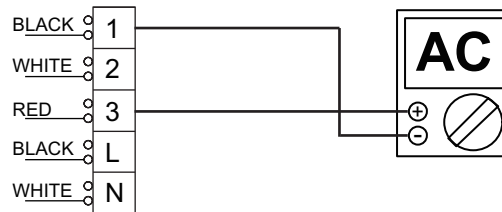

- Check if indicated value swings between AC 90 V and AC 270 V at the outdoor unit terminal 1—3.
- If it is abnormal, check the parts below.
 - Outdoor unit fan motor in "[Service parts information](#)" on page 03-43
- If outdoor fan motor is abnormal, replace outdoor unit fan motor and main PCB.
- If the checked parts are normal, replace the main PCB.



End

Check point 1-2. Check external cause such as noise

- Check the complete insulation of the grounding.
- Check if there is any equipment that causes harmonic wave near the power cable (Neon light bulb or any electronic equipment which causes harmonic wave).



End

2-2. E: 11. Serial communication error (Serial forward transfer error) (Indoor unit)

Indicator	Wired remote controller	Error code	E: 11
Detective actuator	Indoor unit	Main PCB	When the outdoor unit cannot properly receive the serial signal from indoor unit for 10 seconds or more.
		Fan motor	
	Outdoor unit	Main PCB	
Forecast of cause			Connection failure
			External cause
			Main PCB failure

Check point 1. Reset the power and operate

Does error indication show again?

→ If no, go to "Check point 1-2".



Check point 2. Check connection

Check any loose or removed connection line of indoor unit and outdoor unit.

→ If there is an abnormal condition, correct it by referring to the installation manual or the "DESIGN & TECHNICAL MANUAL".

Check connection condition is control unit. (If there is loose connector, open cable or mis-wiring.)



Check point 3. Check the voltage of power supply

Check the voltage of power supply

Check if AC 198 V (AC 220 V -10%) to AC 264 V (AC 240 V +10%) appears at outdoor unit terminal L—N.



Check point 4. Check serial signal (Forward transfer signal)

Check serial signal (Forward transfer signal)

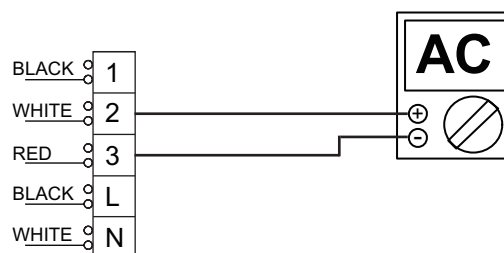

- Check if indicated value swings between AC 30 V and AC 130 V at outdoor unit terminal 2—3.
- If it is abnormal, replace main PCB.



End

Check point 1-2. Check external cause such as noise

- Check if the ground connection is proper.
- Check if there is any equipment that causes harmonic wave near the power cable (Neon light bulb or any electronic equipment which causes harmonic wave).



End

2-3. E: 12. Wired remote controller communication error (Indoor unit)

Indicator	Wired remote controller	Error code	E: 12
Detective actuator	Indoor unit	Main PCB	When the indoor unit cannot receive the signal from wired remote controller more than following time during normal operation. <ul style="list-style-type: none"> • 3-wire type: 1 minute • 2-wire type: 2.5 minutes
	Wired remote control		
Forecast of cause			Terminal connection abnormal
			Wired remote control failure
			Main PCB failure

Check point 1. Check the connection of terminal

After turning off the power, check & correct the followings.

- Check the connection of terminal between wired remote controller and indoor unit, and check if there is a disconnection of the cable.



Check Point : Check Wired remote controller and main PCB

Check voltage at CN6 of main PCB (terminal 1—3). (Power supply to the remote controller)

Upon correcting the removed connector or mis-wiring, reset the power.



- If it is DC 12 V, remote controller is failure. (Main PCB is normal)
 - Replace remote control
- If it is DC 0 V, main PCB is failure. (Check remote controller once again)
 - Replace main PCB



End

2-4. E: 23. Combination error (Outdoor unit)

Indicator	Wired remote controller	Error code	E: 23
Detective actuator	Indoor unit	The outdoor unit receives the serial signal of applied refrigerant information from indoor unit.	
Forecast of cause	Incorrect indoor unit is selected.		

Check point 1. Check the type of indoor unit

- Check the type of the connected indoor unit.
-> If there is an abnormal condition, correct it by refer to the installation manual or the "DESIGN & TECHNICAL MANAL".



Check point 2. Replace the main PCB

If check point 1 do not improve the symptom, replace the main PCB of the outdoor unit.



End

2-5. E: 32. Indoor unit main PCB error (Indoor unit)

Indicator	Wired remote controller	Error code	E: 32
Detective actuator	Indoor unit	main PCB	When power is on and there is some below case. 1. When model information of EEPROM is incorrect. 2. When the access to EEPROM failed.
Forecast of cause			External cause
			Defective connection of electrical components
			Main PCB failure

Check point 1. Reset power supply and operate

Does error indication show again?

→ If no, go to "Check point 1-2".



Check point 2. Check Indoor unit electrical components

- Check all connectors. (loose connector or incorrect wiring)
- Check any shortage or corrosion on PCB.



Check point 3. Replace the main PCB

Replace the main PCB.



End

Check point 1-2. Check external cause such as noise

- Check if the ground connection is proper.
- Check if there is any equipment that causes harmonic wave near the power cable (Neon light bulb or any electronic equipment which causes harmonic wave).



End

NOTE: EEPROM

EEPROM (Electrically Erasable and Programmable Read Only Memory) is a non-volatile memory which keeps memorized information even if the power is turned off. It can change the contents electronically. To change the contents, it uses higher voltage than normal, and it cannot change a partial contents. (Rewriting shall be done upon erasing the all contents.) There is a limit in a number of rewriting.

2-6. E: 41. Room temperature sensor error (Indoor unit)

Indicator	Wired remote controller	Error code	E: 41
Detective actuator	Indoor unit main PCB	Room temperature thermistor is open or short is detected always.	
	Room temperature thermistor		
Forecast of cause			Connector failure
			Thermistor failure
			Main PCB failure

Check point 1. Check connection of connector

- Check if connector is loose or removed.
- Check erroneous connection.
- Check if thermistor cable is open

-> Reset power when reinstalling due to removed connector or incorrect wiring.



Check point 2. Remove connector and check thermistor resistance value

- For the room thermistor resistance value, refer to "[Thermistor resistance values](#)" on page 03-52.
- If thermistor is either open or shorted, replace it and reset the power.

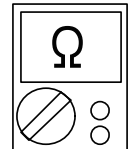

Check point 3. Check voltage of main PCB

Make sure circuit diagram of each indoor unit and check terminal voltage at thermistor (DC 5.0 V).

NOTE: For details of thermistor connector, refer to "[Wiring diagrams](#)" in Chapter 2. TECHNICAL DATA AND PARTS LIST on page 02-15.

(CN8)

If the voltage does not appear, replace main PCB.

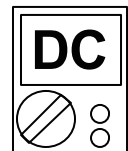

End

2-7. E: 42. Indoor unit heat exchanger sensor error (Indoor unit)

Indicator	Wired remote controller	Error code	E: 42
Detective actuator	Indoor unit main PCB	Heat exchanger temperature thermistor	When heat exchanger temperature thermistor open or short circuit is detected.
Forecast of cause			Connector connection failure
			Thermistor failure
			Main PCB failure

Check point 1. Check connection of connector

- Check if connector is loose or removed.
- Check erroneous connection.
- Check if thermistor cable is open

-> Reset power when reinstalling due to removed connector or incorrect wiring.



Check point 2. Remove connector and check thermistor resistance value

- For the heat exchanger thermistor resistance value, refer to "[Thermistor resistance values](#)" on page 03-52.
- If thermistor is either open or shorted, replace it and reset the power.

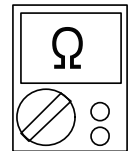

Check point 3. Check voltage of main PCB

Make sure circuit diagram of each indoor unit and check terminal voltage at thermistor (DC 5.0 V).

NOTE: For details of thermistor connector, refer to "[Wiring diagrams](#)" in Chapter 2. TECHNICAL DATA AND PARTS LIST on page 02-15.

(CN32)

If the voltage does not appear, replace main PCB.

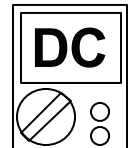

End

2-8. E: 53. Drain pump error (Indoor unit)

Indicator	Wired remote controller	Error code	E: 53
Detective actuator	Indoor unit main PCB Float switch		When Float switch is ON for more than 3 minutes.
Forecast of cause			Float switch failure
			Shorted connector/wire failure
			Main PCB failure
			Drain pump failure
			Hose clogging

Check point 1. Check float switch

- Check operation of float switch. (any blocking by dust, etc.)
- Remove float switch and check ON/OFF switching operation by using a meter.

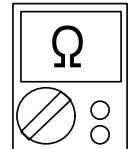

-> If float switch is abnormal, replace it.



Check point 2. Check connector and wire

Check loose contact of CN9 and shorted wire (pinched wire).
-> Replace float switch if the wire is abnormal



Check point 3. Check drain hose

Check drain hose.
-> If there is hose clogging. Please clear the clog.



Check point 4. Replace drain pump

If check point 1 to 3 do not improve the symptom, replace drain pump.



Check point 5. Replace main PCB

If check point 4 do not improve the symptom, replace main PCB.



End

2-9. E: 62. Outdoor unit main PCB error (Outdoor unit)

Indicator	Wired remote controller	Error code	E: 62
Detective actuator	Outdoor unit	Main PCB	Access to EEPROM failed due to some cause after outdoor unit started.
Forecast of cause			External cause (Noise, temporary open, voltage drop) Main PCB failure

Check point 1. Reset power supply and operate

Does error indication show again?

If no, go to "Check point 1-2".



Check point 2. Replace the main PCB

Replace the main PCB.



End

Check point 1-2. Check external cause

- Check if temporary voltage drop was not generated.
- Check if momentary open was not generated.
- Check if ground is connection correctly or there are no related cables near the power line.



End

2-10. E: 63. Inverter error (Outdoor unit)

Indicator	Wired remote controller	Error code	E: 63
Detective actuator	Outdoor unit	Inverter PCB	Error information received from inverter PCB
Forecast of cause			External cause
			Power supply to inverter PCB wiring disconnection or open
			Inverter PCB failure

Check point 1. Turn the power on again?

Error displayed again?

If no, go to "Check point 1-2".



Check point 2. Check the wiring (power supply to inverter PCB)

- Connector and wiring connection state check
- Cable open check



Check point 3. Replace inverter PCB

Replace inverter PCB



End

Check point 1-2. Check external cause

- Check if temporary voltage drop was not generated.
- Check if momentary open was not generated.
- Check if ground is connection correctly or there are no related cables near the power line.



End

2-11. E: 64. PFC circuit error (Outdoor unit)

Indicator	Wired remote controller	Error code	E: 64
Detective actuator	Outdoor unit	Main PCB	<ul style="list-style-type: none"> When inverter input DC voltage is higher than 420 V for over 3 seconds, the compressor stops. If the same operation is repeated 5 times, the compressor stops permanently.
Forecast of cause			External cause
			Connector connection failure
			Main PCB failure

Check point 1. Check external cause at indoor and outdoor (Voltage drop or Noise)

- Instant drop: Check if there is a large load electric apparatus in the same circuit.
- Momentary power failure: Check if there is a defective contact or leak current in the power supply circuit.
- Noise: Check if there is any equipment causing harmonic wave near electric line. (Neon bulb or electric equipment that may cause harmonic wave)
Check the complete insulation of grounding.



Check point 2. Check connection of Connector

- Check if connector is removed.
- Check erroneous connection.
- Check if cable is open.

→ Upon correcting the removed connector or mis-wiring, reset the power.



Check point 3. Replace the main PCB

If check point 1 to 2 do not improve the symptom, replace the main PCB.



End

2-12. E: 65. Trip terminal L error (Outdoor unit)

Indicator	Wired remote controller	Error code	E: 65
Detective actuator	Outdoor unit	Main PCB	When the signal from FO terminal of IPM is "L" (0 V) during the compressor stopping.
Forecast of cause			Main PCB failure

Check point 1. Check main PCB

Replace the outdoor unit main PCB.



End

2-13. E: 71. Discharge thermistor error (Outdoor unit)

Indicator	Wired remote controller	Error code	E: 71
Detective actuator	Outdoor unit main PCB	When discharge pipe temperature thermistor open or short circuit is detected at power on or while running the compressor	
	Discharge pipe temperature thermistor		
Forecast of cause			Connector failure
			Thermistor failure
			Main PCB failure

Check point 1. Check connection of connector

- Check if connector is loose or removed.
- Check erroneous connection.
- Check if thermistor cable is open

→ Reset power when reinstalling due to removed connector or incorrect wiring.



Check point 2. Remove connector and check thermistor resistance value

- For the discharge temperature thermistor resistance value, refer to "[Thermistor resistance values](#)" on page 03-52.
- If thermistor is either open or shorted, replace it and reset the power.

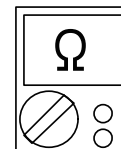

Check point 3. Check voltage of main PCB

Make sure circuit diagram of outdoor unit and check terminal voltage at thermistor (DC 5.0 V).

NOTE: For details of thermistor connector, refer to "[Wiring diagrams](#)" in Chapter 2. TECHNICAL DATA AND PARTS LIST on page 02-15.



If the voltage does not appear, replace main PCB.



End

2-14. E: 72. Compressor thermistor error (Outdoor unit)

Indicator	Wired remote controller	Error code	E: 72
Detective actuator	Outdoor unit main PCB	When compressor temperature thermistor open or short circuit is detected at power on or while running the compressor	
	Compressor temperature thermistor		
Forecast of cause			Connector failure
			Thermistor failure
			Main PCB failure

Check point 1. Check connection of connector

- Check if connector is loose or removed.
- Check erroneous connection.
- Check if thermistor cable is open

→ Reset power when reinstalling due to removed connector or incorrect wiring.



Check point 2. Remove connector and check thermistor resistance value

- For the compressor thermistor resistance value, refer to "[Thermistor resistance values](#)" on page 03-52.
- If thermistor is either open or shorted, replace it and reset the power.

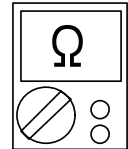

Check point 3. Check voltage of main PCB

Make sure circuit diagram of outdoor unit and check terminal voltage at thermistor (DC 5.0 V).

NOTE: For details of thermistor connector, refer to "[Wiring diagrams](#)" in Chapter 2. TECHNICAL DATA AND PARTS LIST on page 02-15.

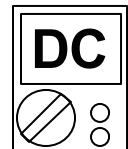

If the voltage does not appear, replace main PCB.



End

2-15. E: 73. Heat exchanger (Middle/Outlet) temperature thermistor error (Outdoor unit)

Indicator	Wired remote controller	Error code	E: 73
Detective actuator	Heat exchanger liquid temperature thermistor		• Heat exchanger liquid temperature thermistor short or open detected
	Heat exchanger middle temperature thermistor		• Heat exchanger middle temperature thermistor short or open detected
Forecast of cause			Connector failure
			Thermistor failure
			Main PCB failure

Check Point 1 : Check the connector connection and cable open

- Connector connection state check
- Cable open check



Check Point 2 : Check the thermistor

- For the outdoor unit heat exchanger thermistor resistance value, refer to "[Thermistor resistance values](#)" on page 03-52.
- If thermistor is either open or shorted, replace it and reset the power.



Check point 3. Check voltage of main PCB

Make sure circuit diagram of outdoor unit and check terminal voltage at thermistor (DC 5.0 V).

NOTE: For details of thermistor connector, refer to "[Wiring diagrams](#)" in Chapter 2. TECHNICAL DATA AND PARTS LIST on page 02-15.



If the voltage does not appear, replace main PCB.



End

2-16. E: 74. Outdoor temperature thermistor error (Outdoor unit)

Indicator	Wired remote controller	Error code	E: 74
Detective actuator	Outdoor unit main PCB	When outdoor temperature thermistor open or short circuit is detected at power on or while running the compressor	
	Outdoor temperature thermistor		
Forecast of cause			Connector failure
			Thermistor failure
			Main PCB failure

Check point 1. Check connection of connector

- Check if connector is loose or removed.
- Check erroneous connection.
- Check if thermistor cable is open

-> Reset power when reinstalling due to removed connector or incorrect wiring.



Check point 2. Remove connector and check thermistor resistance value

- For the outdoor temperature thermistor resistance value, refer to "[Thermistor resistance values](#)" on page 03-52.
- If thermistor is either open or shorted, replace it and reset the power.

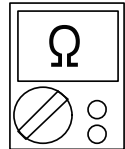

Check point 3. Check voltage of main PCB

Make sure circuit diagram of outdoor unit and check terminal voltage at thermistor (DC 5.0 V).

NOTE: For details of thermistor connector, refer to "[Wiring diagrams](#)" in Chapter 2. TECHNICAL DATA AND PARTS LIST on page 02-15.



If the voltage does not appear, replace main PCB.



End

2-17. E: 77. Heat sink thermistor error (Outdoor unit)

Indicator	Wired remote controller	Error code	E: 77
Detective actuator	Heat sink temperature thermistor	Heat sink temperature thermistor short or open detected	
Forecast of cause			Connector failure
			Thermistor failure
			Inverter PCB failure

Check point 1. Check connection of connector

- Check if connector is loose or removed.
- Check erroneous connection.
- Check if thermistor cable is open

-> Reset power when reinstalling due to removed connector or incorrect wiring.



Check point 2. Remove connector and check thermistor resistance value

- For the Heat sink thermistor resistance value, refer to "[Thermistor resistance values](#)" on page 03-52.
- If thermistor is either open or shorted, replace it and reset the power.

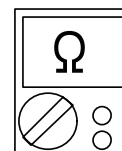

Check point 3. Check voltage of inverter PCB

Make sure circuit diagram of outdoor unit and check terminal voltage at thermistor (DC 5.0 V).

NOTE: For details of thermistor connector, refer to "[Wiring diagrams](#)" in Chapter 2. TECHNICAL DATA AND PARTS LIST on page 02-15.



If the voltage does not appear, replace inverter PCB.



End

2-18. E: 84. Current sensor error (Outdoor unit)

Indicator	Wired remote controller	Error code	E: 84
Detective actuator	Outdoor unit	main PCB	When input current sensor has detected 0 A, while inverter compressor is operating at higher than 50 rps, after 1 minute upon starting the compressor. (Except during the defrost operation)
Forecast of cause			Defective connection of electrical components
			External cause
			Main PCB failure

Check point 1. Reset power supply and operate

Does error indication show again?

If no, go to "Check point 1-2".



Check point 2. Check connections of outdoor unit electrical components

- Check if the terminal connection is loose.
- Check if connector is removed.
- Check erroneous connection.
- Check if cable is open.

Upon correcting the removed connector or miswiring, reset the power.



Check point 3. Replace the main PCB

If Check point 1, 2 do not improve the symptom, replace the main PCB.



End

Check point 1-2. Check external cause at Indoor and Outdoor (Voltage drop or Noise)

- Instant drop: Check if there is a large load electric apparatus in the same circuit.
- Momentary power failure: Check if there is a defective contact or leak current in the power supply circuit.
- Noise: Check if there is any equipment causing harmonic wave near electric line. (Neon bulb or electric equipment that may cause harmonic wave)
Check the complete insulation of grounding.



End

2-19. E: 86. Pressure sensor error (Outdoor unit)

Indicator	Wired remote controller	Error code	E: 86
Detective actuator	Outdoor unit main PCB	30 seconds or more after power-on, when pressure sensor detection value detects the condition below continuously for 30 seconds or more. $P_s \leq 0$ or $P_s \geq 5$ [MPa]	
	High pressure switch		
Forecast of cause			Connector connection failure
			Pressure sensor failure
			Main PCB failure

Check point 1. Check connection of the pressure sensor

- Check if the terminal connection is loose.
- Check if connector is removed.
- Check erroneous connection.
- Check if cable is open.

-> Upon correcting the removed connector or mis-wiring, reset the power.



Check point 2. Check output voltage of main PCB

Make sure circuit diagram of outdoor unit and check terminal voltage at thermistor (DC 5.0 V \pm 5%).

NOTE: For details of thermistor connector, refer to "[Wiring diagrams](#)" in Chapter 2. TECHNICAL DATA AND PARTS LIST on page 02-15.

If the voltage is not correct, replace main PCB.



Check point 3. Check output voltage of pressure sensor

Make sure circuit diagram of outdoor unit and check terminal voltage. Voltage is refer to the following graph.

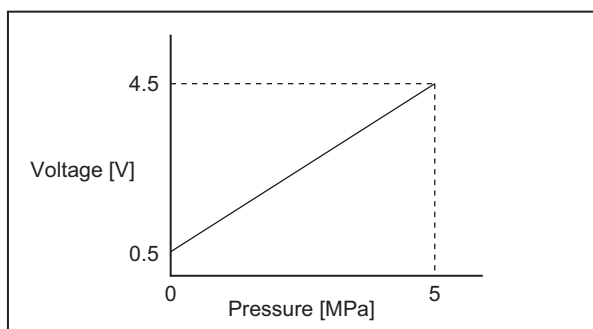

If the voltage is not correct, replace pressure sensor.



End

2-20. E: 94. Trip detection (Outdoor unit)

Indicator	Wired remote controller	Error code	E: 94
Detective actuator	Outdoor unit	Inverter PCB	Protection stop by over-current generation after inverter compressor start processing completed generated consecutively 10 times. NOTE: The number of generations is reset when the compressor starts up.
		Main PCB	
		Compressor	
Forecast of cause			Outdoor unit fan operation defective, foreign matter on heat-exchanger, excessive rise of ambient temperature
			Main PCB failure
			Inverter compressor failure (lock, winding short)
			Inverter PCB

Check point 1. Check the outdoor unit fan operation, heat-exchanger, ambient temperature

- No obstructions in air passages?
- Heat exchange fins clogged
- Outdoor unit fan motor check
- Ambient temperature not raised by the effect of other heat sources?
- Discharged air not sucked in?



Check point 2. Replace inverter PCB

If Check point 1 do not improve the symptom, change inverter PCB.



Check point 3. Replace main PCB

If Check point 1, 2 do not improve the symptom, change main PCB.



Check point 4. Replace compressor

If Check point 3 do not improve the symptom, change compressor.



End

2-21. E: 95. Compressor motor control error (Outdoor unit)

Indicator	Wired remote controller	Error code	E: 95
Detective actuator	Outdoor unit	Main PCB	"Protection stop by "overcurrent generation at inverter compressor starting" restart" generated consecutively 10 times x 3 sets (total 30 times)
		Compressor	
Forecast of cause			Defective connection of electrical components
			Main PCB failure
			Compressor failure

Check point 1. Check noise from compressor

Turn on power and check operation noise.
→ If an abnormal noise show, replace compressor.



Check point 2. Check connection of around the compressor components

For compressor terminal, main PCB

- Check if connector is removed.
- Check erroneous connection.
- Check if cable is open. (Refer to inverter compressor in "[Service parts information](#)" on page 03-43.)

→ Upon correcting the removed connector or mis-wiring, reset the power.



Check point 3. Replace main PCB

If Check point 1, 2 do not improve the symptom, change main PCB.



Check point 4. Replace compressor

If Check point 3 do not improve the symptom, change compressor.



End

2-22. E: 97. Outdoor unit fan motor error (Outdoor unit)

Indicator	Wired remote controller	Error code	E: 97
Detective actuator	Outdoor unit	Main PCB	<ol style="list-style-type: none"> When outdoor fan rotation speed is less than 100 rpm in 20 seconds after fan motor starts, fan motor stops. After fan motor restarts, if the same operation within 60 seconds is repeated 3 times in a row, compressor and fan motor stops. If 1. and 2. repeats 5 times in a row, compressor and fan motor stops permanently.
		Fan motor	
Forecast of cause			Fan rotation failure
			Motor protection by surrounding temperature rise
			Main PCB failure
			Outdoor unit fan motor

Check point 1. Check rotation of fan

Rotate the fan by hand when operation is off. (Check if fan is caught, dropped off or locked motor)
→ If fan or bearing is abnormal, replace it.



Check point 2. Check ambient temperature around motor

Check excessively high temperature around the motor. (If there is any surrounding equipment that causes heat)
→ Upon the temperature coming down, restart operation.



Check point 3. Check outdoor unit fan motor

Check outdoor unit fan motor. (Refer to outdoor unit fan motor in "[Service parts information](#)" on page 03-43.)
→ If outdoor unit fan motor is abnormal, replace outdoor unit fan motor and main PCB.



Check point 4. Check output voltage of main PCB

Check outdoor unit circuit diagram and the voltage. (Measure at main PCB side connector)

NOTE: For details of wiring diagram, refer to "[Wiring diagrams](#)" in Chapter 2. TECHNICAL DATA AND PARTS LIST on page 02-15.



Read wire	DC voltage
Red—Black	360 V (DC 340 V -10%) to 374 V (DC 340 V +10%)
White—Black	15 ±1.5 V

-> If the voltage is not correct, replace Main PCB.



End

2-23. E: 99. 4-way valve error (Outdoor unit)

Indicator	Wired remote controller	Error code	E: 99
Detective actuator	Indoor unit	main PCB	When the indoor heat exchanger temperature is compared with the room temperature, and either following condition is detected continuously two times, the compressor stops. Indoor heat exchanger temp. - Room temp. > 10 °C (Cooling or Dry operation) Indoor heat exchanger temp. - Room temp. < -10 °C (Heating operation) If the same operation is repeated 5 times, the compressor stops permanently.
	Heat exchanger temperature thermistor		
	Room temperature thermistor		
	4-way valve		
Forecast of cause			Air filter clogged
			Connector connection failure
			Thermistor failure
			Coil failure
			4-way valve failure
		Main PCB failure	

Check point 1. Check air filter condition

Check air filter dirty.

→ If the air filter dirty, clean up the air filter.



Check point 2. Check connection of connector

- Check if connector is removed.
- Check erroneous connection.
- Check if thermistor cable is open.

→ Upon correcting the removed connector or mis-wiring, reset the power.



Check point 3. Check each thermistor

- Isn't it fallen off the holder?
- Is there a cable pinched?

Check characteristics of room thermistor and indoor unit heat exchanger thermistor.

For the thermistor resistance value, refer to "[Thermistor resistance values](#)" on page 03-52.

→ If defective, replace the thermistor.



Check point 4. Check the solenoid coil and 4-way valve

NOTE: Refer solenoid coil and 4-way valve in "[Service parts information](#)" on page 03-43.

- **Solenoid coil**
Remove P60 from PCB and check the resistance value of coil. Resistance value is 1.97 kΩ.
→ If it is open or abnormal resistance value, replace solenoid coil.
- **4-way valve**
Check each piping temperature, and the location of the valve by the temperature difference.
If the value location is not proper, replace 4-way valve.

**Check point 5. Replace main PCB**

If Check Point 1 to 4 do not improve the symptom, replace main PCB.



End

2-24. E: A1. Discharge temperature error (Outdoor unit)

Indicator	Wired remote controller	Error code	E: A1
Detective actuator	Outdoor unit main PCB		Protection stop by discharge temperature ≥ 110 °C during compressor operation generated 2 times within 24 hours.
	Discharge temperature thermistor		
Forecast of cause			3-way valve not opened
			EEV or capillary tube defective, strainer clogged
			Outdoor unit operation failure, foreign matter on heat exchanger
			Discharge temperature thermistor failure
			Insufficient refrigerant
			Main PCB failure

Check point 1. Check if 3-way valve is open

If the 3-way valve is closed, open the 3-way valve and check operation.

NOTE: For cooling operation, check gas side of the 3-way valve.
For heating operation, check liquid side of the 3-way valve.



Check point 2. Check any of the electronic expansion valve (EEV), capillary tube, or strainer, or all

- Check if EEV open or there is a capillary tube defect. Refer to outdoor unit Electronic Expansion Valve (EEV) or Capillary tube in "[Service parts information](#)" on page 03-43.
- Check the strainer clogging.



Check point 3. Check the outdoor unit fan and heat exchanger

- Check for foreign object at heat exchanger
- Check if fan can be rotated by hand.
- Check the motor. (Refer to outdoor unit fan motor in "[Service parts information](#)" on page 03-43.)



Check point 4. Check the discharge thermistor

The discharge temperature thermistor characteristics check. (Check by disconnecting thermistor from PCB.)

NOTE: For the characteristics of the thermistor, refer to "[Thermistor resistance values](#)" on page 03-52.



Check point 5. Check the refrigerant amount

Check the refrigerant leakage.



Check point 6. Replace the main PCB

If check point 1 to 5 do not improve the symptom, replace the main PCB.



End

2-25. E: A3. Compressor temperature error (Outdoor unit)

Indicator	Wired remote controller	Error code	E: A3
Detective actuator	Outdoor unit main PCB		Protection stop by compressor temperature ≥ 108 °C during compressor operation generated 2 times within 24 hours.
	Compressor temperature thermistor		
Forecast of cause			3-way valve not opened
			EEV defective, strainer clogged
			Outdoor unit operation failure, foreign matter on heat exchanger
			Compressor temperature thermistor failure
			Insufficient refrigerant
			Main PCB failure

Check point 1. Check if 3-way valve is open

If the 3-way valve is closed, open the 3-way valve and check operation.

NOTE: For cooling operation, check gas side of the 3-way valve.
For heating operation, check liquid side of the 3-way valve.



Check point 2. Check the electronic expansion valve (EEV) and strainer

- Check if EEV open.
Refer to outdoor unit Electronic Expansion Valve (EEV) in "[Service parts information](#)" on page 03-43.
- Check the strainer clogging.



Check point 3. Check the outdoor unit fan and heat exchanger

- Check for foreign object at heat exchanger
- Check if fan can be rotated by hand.
- Check the motor. (Refer to outdoor unit fan motor in "[Service parts information](#)" on page 03-43.)



Check point 4. Check the compressor thermistor

The compressor temperature thermistor characteristics check. (Check by disconnecting thermistor from PCB.)

NOTE: For the characteristics of the thermistor, refer to "[Thermistor resistance values](#)" on page 03-52.



Check point 5. Check the refrigerant amount

Check the refrigerant leakage.



Check point 6. Replace the main PCB

If check point 1 to 5 do not improve the symptom, replace the main PCB.



End

2-26. E: AC. Heat sink temperature error (Outdoor unit)

Indicator	Wired remote controller	Error code	E: AC
Detective actuator	Outdoor unit inverter PCB		Protection stop by heat sink temperature ≥ 80 °C during heat sink operation generated 2 times within 24 hours.
	Heat sink temperature thermistor		
Forecast of cause			Foreign matter on heat sink, heat sink dirty
			Foreign matter on heat exchanger, excessive ambient temperature rise
			Heat sink temp. thermistor defective

Check point 1. Check the heat sink state

Heat sink foreign matter, soiling check



Check point 2. Check the foreign matter and ambient temperature of heat exchanger

- Heat exchange foreign matter check
- Ambient temperature not raised by effect of other heat sources?
- Discharged air not sucked in?



Check point 3. Check the heat sink temperature thermistor

The heat sink temperature thermistor characteristics check. (Check by disconnecting thermistor from PCB.)

NOTE: For the characteristics of the thermistor, refer to "[Thermistor resistance values](#)" on page 03-52.



Check point 4. Replace inverter PCB

Replace inverter PCB



End

3. Troubleshooting without error code

3-1. Indoor unit—No power

Forecast of cause	Power supply failure
	External cause
	Electrical components defective

Check point 1. Check installation condition

- Isn't the breaker down?
- Check loose or removed connection cable.

-> If abnormal condition is found, correct it by referring to the installation manual or the "DESIGN & TECHNICAL MANUAL".



Check point 2. Check external cause at indoor and outdoor (voltage drop or noise)

- Instant drop: Check if there is a large load electric apparatus in the same circuit.
- Momentary power failure: Check if there is a defective contact or leak current in the power supply circuit.
- Noise: Check if there is any equipment causing harmonic wave near electric line. (Neon bulb or electric equipment that may cause harmonic wave)
Check the complete insulation of grounding.



Check point 3. Check electrical components

Check the voltage of power supply.

Check if AC 198 to 264 V appears at outdoor unit terminal L—N.

-> If no, go to "[Check point 1](#)" and "[Check point 2](#)".



- Check fuse in filter PCB.
If fuse is open, check if the wiring between terminal and filter PCB is loose, and replace fuse.
- Check varistor in filter PCB.
If varistor is defective, there is a possibility of an abnormal power supply.
Check the correct power supply and replace varistor.
Upon checking the normal power supply, replace varistor.



End

3-2. Outdoor unit—No power

Forecast of cause	Power supply failure
	External cause
	Electrical components defective

Check point 1. Check installation condition

- Is the circuit breaker on or off?
- Check loose or removed connection cable.

→ If abnormal condition is found, correct it by referring to the installation manual or the "DESIGN & TECHNICAL MANUAL".



Check point 2. Check external cause at indoor and outdoor (voltage drop or noise)

- Instant drop: Check if there is a large load electric apparatus in the same circuit.
- Momentary power failure: Check if there is a defective contact or leak current in the power supply circuit.
- Noise: Check if there is any equipment causing harmonic wave near electric line. (Neon bulb or electric equipment that may cause harmonic wave)
Check the complete insulation of grounding.



Check point 3. Check electrical components

Check the voltage of power supply.

Check if AC 198 to 264 V appears at outdoor unit terminal L—N

→ If no, go to "[Check point 1](#)" and "[Check point 2](#)".

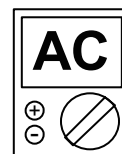

- Check fuse in main PCB.
If fuse is open, check if the wiring between terminal and main PCB is loose, and replace fuse.
- Check varistor in main PCB.
If varistor is defective, there is a possibility of an abnormal power supply. Check the correct power supply and replace varistor.
→ Upon checking the normal power supply, replace varistor.



Check point 4. Replace the main PCB

If check point 1 to 3 do not improve the symptom, replace the main PCB.



End

3-3. No operation (Power is on)

Forecast of cause	Setting/ Connection failure
	External cause
	Electrical components defective

Check point 1. Check indoor and outdoor installation condition

- Indoor unit:
 - Check incorrect wiring between indoor unit and remote controller.
 - Check if there is an open cable connection.
 - Are these indoor unit, outdoor unit, and remote controller suitable model names to connect?
- > If there is some abnormal condition, correct it by referring to the installation manual and “DESIGN & TECHNICAL MANUAL”.



Turn off the power and check correct followings.

- Is there loose or removed communication line of indoor unit and outdoor unit?



Check point 2. Check external cause at indoor and outdoor (Voltage drop or Noise)

- Instant drop: Check if there is a large load electric apparatus in the same circuit.
- Momentary power failure: Check if there is a defective contact or leak current in the power supply circuit.
- Noise: Check if there is any equipment causing harmonic wave near electric line. (Neon bulb or electric equipment that may cause harmonic wave)
Check the complete insulation of grounding.



Check point 3. Check wired remote controller and controller PCB

Check voltage at CN6 (terminal 1—3) of main PCB.
(Power supply to remote controller)

- If it is DC 12V, remote controller is failure. (The controller PCB is normal)
-> Replace remote controller.
- If it is DC 0 V, controller PCB is failure. (Check the remote controller once again)
-> Replace controller PCB.



Check point 4. Replace main PCB

If check point 1 to 3 do not improve the symptom, change main PCB.



End

3-4. No cooling/No heating

Forecast of cause	Indoor unit error
	Outdoor unit error
	Effect by surrounding environment
	Connection pipe/Connection wire failure
	Refrigeration cycle failure

Check point 1. Check Indoor unit

- Does Indoor unit fan run in the HIGH mode?
- Is air filter dirty?
- Is heat exchanger clogged?
- Check if energy save function is operated.



Check point 2. Check outdoor unit operation

- Check if outdoor unit is operating.
- Check any objects that obstruct the air flow route.
- Check if heat exchanger is clogged.
- Is the valve open?



Check point 3. Check site condition

- Is capacity of Indoor unit fitted to the room size?
- Any windows open or direct sunlight?



Check point 4. Check indoor/outdoor installation condition

- Check connection pipe (specified pipe length and pipe diameter?)
- Check any loose or removed communication line.

→ If there is an abnormal condition, correct it by referring to the installation manual or the "DESIGN & TECHNICAL MANUAL".



Check point 5. Check Refrigeration cycle

- Check if strainer is clogged (Refer to the figure below).
- Measure gas pressure, and if there is a leakage, correct it.
- Check if EEV open or there is a capillary tube defect.
Refer to outdoor unit Electronic Expansion Valve (EEV) or Capillary tube in "[Service parts information](#)" on page 03-43.
- Check compressor.
Refer to compressor in "[Service parts information](#)" on page 03-43.
Refer to inverter compressor in "[Service parts information](#)" on page 03-43.

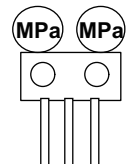

NOTE: When recharging the refrigerant, make sure to perform vacuuming, and recharge the specified amount.



End

NOTES:

- Strainer normally does not have temperature difference between inlet and outlet as shown below.

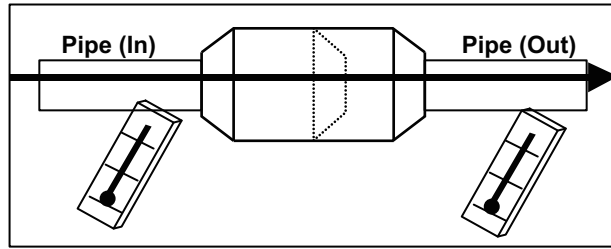

- If there is a difference like shown below, there is a possibility of inside clogged. In this case, replace the strainer.

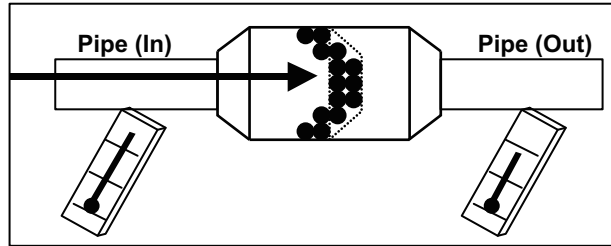

3-5. Abnormal noise

Forecast of cause	Abnormal installation (indoor unit/outdoor unit)
	Fan failure (indoor unit/outdoor unit)
	Compressor failure (outdoor)

Diagnosis method when abnormal noise is occurred

Abnormal noise is coming from Indoor unit.
(Check and correct followings)



- Is main unit installed in stable condition?
- Is the installation of air suction grille and front panel normal?



- Is fan broken or deformed?
- Is the screw of fan loose?
- Is there any object which obstruct the fan rotation?



End

Abnormal noise is coming from Outdoor unit.
(Check and correct followings)



- Is main unit installed in stable condition?
- Is fan guard installed normally?



- Is fan broken or deformed?
- Is the screw of fan loose?
- Is there any object which obstruct the fan rotation?



Check if vibration noise by loose bolt or contact noise of piping is happening.



Is compressor locked?

- Check Compressor
Refer to compressor and inverter compressor in "[Service parts information](#)" on page 03-43.



End

3-6. Water leaking

Forecast of cause	Erroneous installation
	Drain hose failure

Diagnosis method when water leak occurs

- Is main unit installed in stable condition?
- Is main unit broken or deformed at the time of transportation or maintenance?



- Is drain hose connection loose?
- Is there a trap in drain hose?
- Is drain hose clogged?



Is fan rotating?



End

Diagnosis method when water is spitting out

Is the filter clogged?



Check gas pressure and correct it if there was a gas leak.

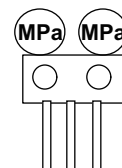

End

TROUBLESHOOTING

TROUBLESHOOTING

4. Service parts information

4-1. Compressor

Diagnosis method of compressor (If outdoor unit LED displays error, refer to troubleshooting)

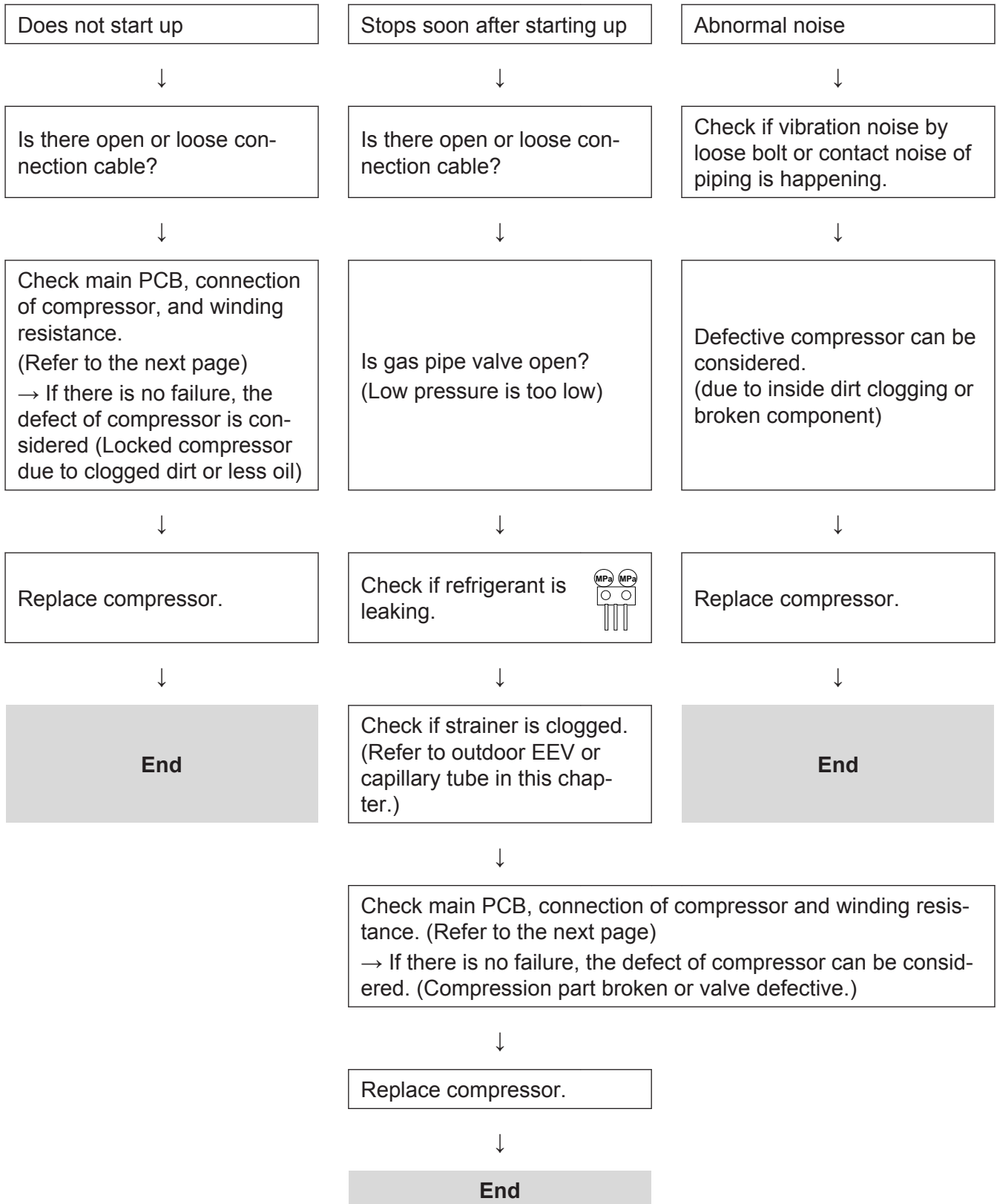

4-2. Inverter compressor

Check point 1. Check connection

- Check terminal connection of compressor (loose or incorrect wiring)

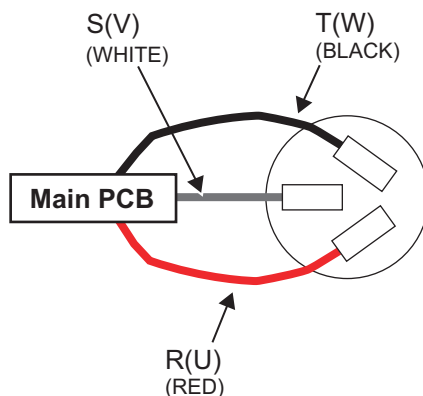

- Check terminal connection of main PCB (loose or incorrect wiring)

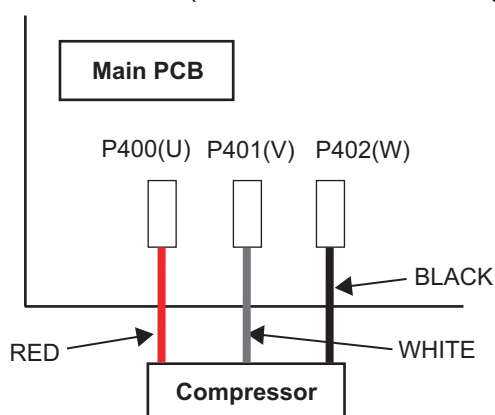

↓

Check point 2. Check winding resistance

Check winding resistance of each terminal.

Resistance value: $1.546 \Omega \pm 8\%$ at 20°C

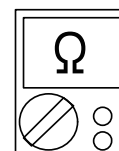
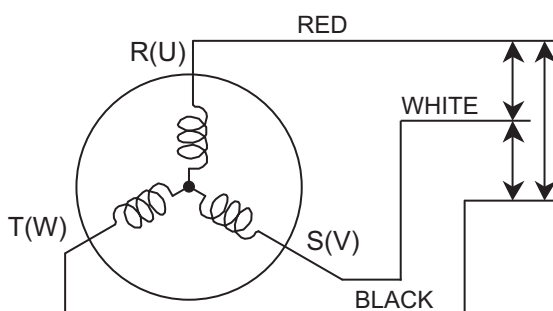

→ If the resistance value is 0Ω or infinite, replace compressor.

↓

Check point 3. Replace inverter PCB

If check point 1 to 2 do not improve the symptom, replace main PCB.

4-3. Outdoor unit Electronic Expansion Valve (EEV)

Check point 1. Check connections

Check connection of connector. (Loose connector or open cable)

NOTE: For details of wiring diagram, refer to "Wiring diagrams" in Chapter 2. TECHNICAL DATA AND PARTS LIST on page 02-15.

Check point 2. Check coil of EEV

Remove connector, check each winding resistance of coil.

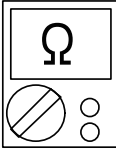
Read wire	Resistance value
1(Red) - 2(Blue)	$46 \Omega \pm 3 \Omega$ at 20 °C 
1(Red) - 3(Orange)	
1(Red) - 4(Yellow)	
1(Red) - 5(White)	

→ If Resistance value is abnormal, replace EEV.

Check point 3. Check Voltage from main PCB

Remove connector and check voltage (DC 12 V)

→ If it does not appear, replace main PCB.



Check point 4. Check noise at start up

Turn on the power and check the operation noise.

→ If an abnormal noise does not show, replace main PCB.

Check point 5. Check Opening and Closing Operation of Valve

When valve is closed, it has a temp. difference between inlet and outlet

CLOSE
 Example : Hot Gas

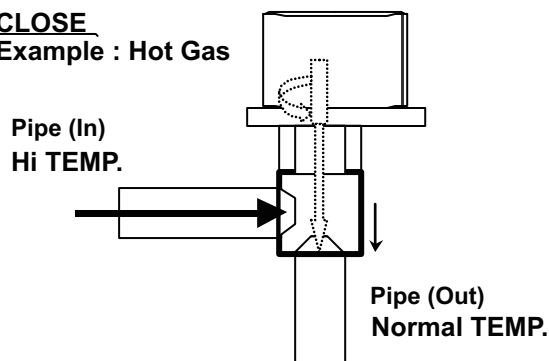

If it is open, it has no temp. difference between inlet and outlet

OPEN
 Example : Hot Gas

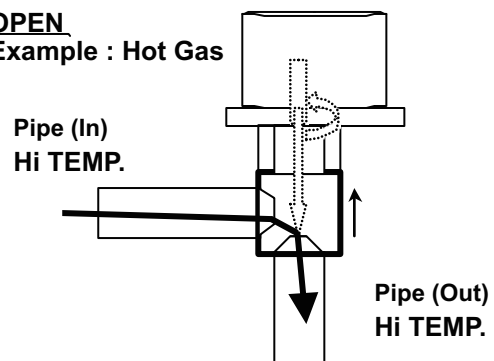

Check point 6. Check strainer

- Strainer normally does not have temperature difference between inlet and outlet as shown below.

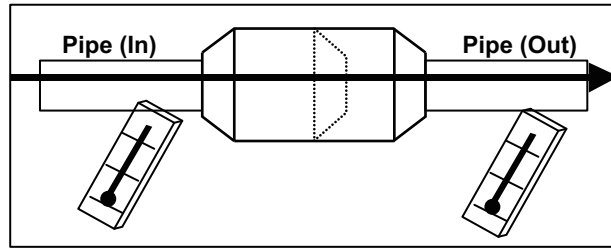

- If there is a difference like shown below, there is a possibility of inside clogged. In this case, replace the strainer.

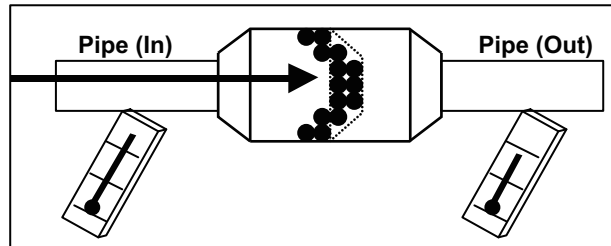

4-4. Indoor unit fan motor

Check point 1. Check rotation of fan

Rotate the fan by hand when operation is off.
 (Check if fan is caught, dropped off or locked motor)
 → If fan or bearing is abnormal, replace it.

Check point 2. Check resistance of indoor fan motor

Check each winding resistance of the motor
 → If Resistance value is abnormal, replace motor.

Lead wire	Resistance value
White - Red	$7.73 \Omega \pm 7 \%$
Red - Black	$7.08 \Omega \pm 7 \%$
Red - Violet	$3.80 \Omega \pm 7 \%$
Violet - Blue	$3.80 \Omega \pm 7 \%$

(20 °C)

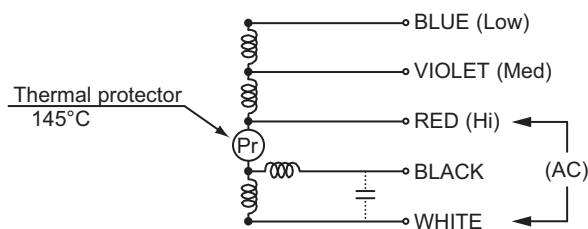

4-5. Outdoor unit fan motor

Check point 1. Check rotation of fan

Rotate the fan by hand when operation is off.
 (Check if fan is caught, dropped off or locked motor)
 → If fan or bearing is abnormal, replace it.

Check point 2. Check resistance of outdoor fan motor

Refer to below. Circuit-test “Vm” and “GND” terminal

NOTE: Vm: DC voltage, GND: Earth terminal

→ If they are short-circuited (below 300 kΩ), replace outdoor fan motor and controller PCB.

Pin number (wire color)	Terminal function (symbol)
1 (Red)	DC voltage (Vm)
2	No function
3	No function
4 (Black)	Earth terminal (GND)
5 (White)	Control voltage (Vcc)
6 (Yellow)	Speed command (Vsp)
7 (Brown)	Feed back (FG)

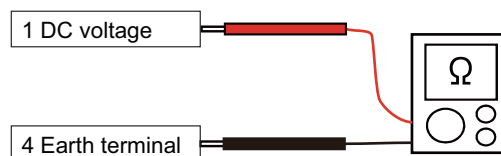

4-6. Pressure switch

- Type of contact

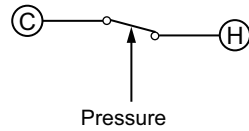

- Characteristics of pressure switch

Pressure switch 1	
Contact: Short → Open	4.2 — 4.05 MPa
Contact: Open → Short	3.2 ± 0.15 MPa

P770

4-7. 4-way valve coil (solenoid coil)/4-way valve

Check point 1. Check connection

- Check the connection of connector P60.

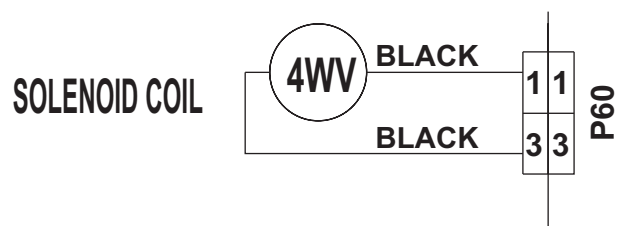

↓

Check Point 2 : Check solenoid coil

Remove P60 from PCB and check the resistance value of coil.

Resistance Value $\approx 1.97 \text{ k}\Omega$

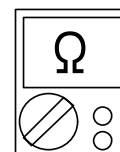

→ If it is Open or abnormal resistance value, replace solenoid coil.

↓

Check Point 3: Check operation of 4-way valve

Check each piping temperature, and confirm the location of the valve by the temperature difference

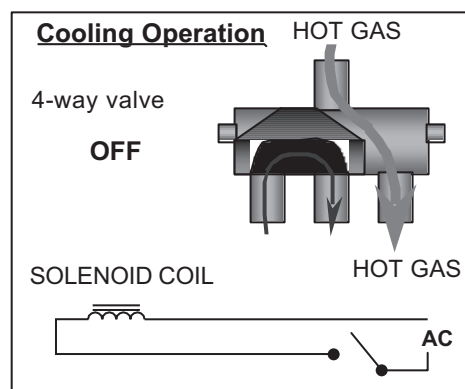
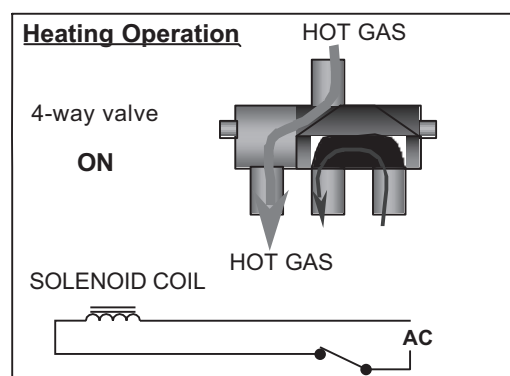

→ If the valve location is not proper, replace 4-way valve.

↓

Check Point 4: Replace main PCB

If none of Checks 1 to 3 apply, replace the main PCB.

4-8. Discharge pressure sensor

Check point 1. Check voltage from main PCB

With the connector connected to the PCB, measure the voltage between P20:2-3 of the Main PCB.

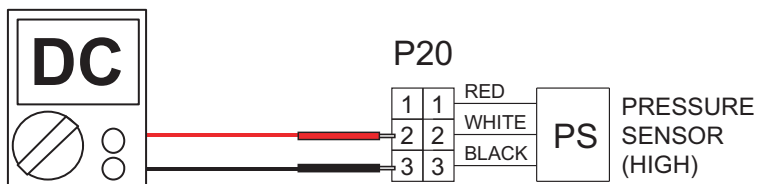

Characteristics of pressure sensor

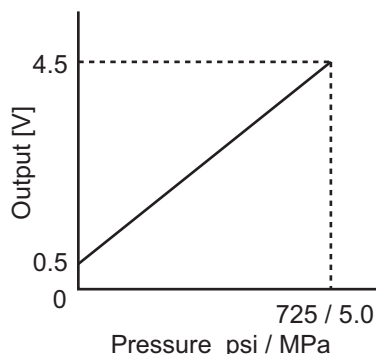

psi	0.0	14.5	29.0	43.5	58.0	72.5	101.5	116.0	130.5	145.0
MPa	0.0	0.10	0.20	0.30	0.40	0.50	0.60	0.80	0.90	1.00
Output (V)	0.50	0.58	0.66	0.74	0.82	0.90	1.06	1.14	1.22	1.30

psi	174.0	203.0	232.0	261.0	290.0	319.0	343.0	377.0	406.0	435.0
MPa	1.20	1.40	1.60	1.80	2.00	2.20	2.40	2.60	2.80	3.00
Output (V)	1.46	1.62	1.78	1.94	2.10	2.26	2.42	2.58	2.74	2.90

psi	464.0	493.0	522.0	551.0	580.0	609.0	638.0	667.0	696.0	725.0
MPa	3.20	3.40	3.60	3.80	4.00	4.20	4.40	4.60	4.80	5.00
Output (V)	3.06	3.22	3.38	3.54	3.70	3.86	4.02	4.18	4.34	4.50

TROUBLESHOOTING

TROUBLESHOOTING

5. Thermistor resistance values

5-1. Indoor unit

■ Room temperature thermistor

Temperature (°C)	Resistance (kΩ)	Voltage (V)
-10.0	58.25	0.73
-5.0	44.03	0.93
0.0	33.62	1.15
5.0	25.93	1.39
10.0	20.18	1.66
15.0	15.84	1.94
20.0	12.54	2.22
25.0	10.00	2.50
30.0	8.04	2.77
35.0	6.51	3.03
40.0	5.30	3.27
45.0	4.35	3.49

■ Heat exchanger temperature thermistor

Temperature (°C)	Resistance (kΩ)	Voltage (V)
-30.0	1,131.91	0.21
-25.0	804.52	0.29
-20.0	579.59	0.40
-15.0	422.89	0.53
-10.0	312.27	0.69
-5.0	233.21	0.88
0.0	176.03	1.10
5.0	134.23	1.36
10.0	103.34	1.63
15.0	80.28	1.92
20.0	62.91	2.21
25.0	49.70	2.51
30.0	39.57	2.79
35.0	31.74	3.06
40.0	25.64	3.30
45.0	20.85	3.53
50.0	17.06	3.73
55.0	14.05	3.90
60.0	11.64	4.05
65.0	9.69	4.19

5-2. Outdoor unit

■ Heatsink thermistor

Temperature (°C)	Resistance (kΩ)	Voltage (V)
-30.0	94.26	0.08
-25.0	67.95	0.11
-20.0	49.62	0.15
-15.0	36.68	0.20
-10.0	27.42	0.26
-5.0	20.73	0.34
0.0	15.83	0.43
5.0	12.21	0.55
10.0	9.50	0.68
15.0	7.46	0.84
20.0	5.90	1.01
25.0	4.71	1.21
30.0	3.78	1.42
35.0	3.06	1.64
40.0	2.50	1.88
45.0	2.05	2.11
50.0	1.69	2.35
55.0	1.40	2.58
60.0	1.17	2.81
65.0	0.98	3.02
70.0	0.83	3.22
75.0	0.70	3.41
80.0	0.60	3.58
85.0	0.51	3.73
90.0	0.44	3.87
95.0	0.38	3.99
100.0	0.33	4.10

■ Discharge temperature thermistor

Temperature (°C)	Resistance (kΩ)	Voltage (V)
-30.0	1,013.11	0.06
-25.0	729.09	0.09
-20.0	531.56	0.12
-15.0	392.31	0.16
-10.0	292.91	0.21
-5.0	221.09	0.28
0.0	168.60	0.36
5.0	129.84	0.46
10.0	100.91	0.57
15.0	79.12	0.71
20.0	62.55	0.86
25.0	49.84	1.03
30.0	40.01	1.23
35.0	32.35	1.43
40.0	26.34	1.65
45.0	21.58	1.88
50.0	17.79	2.11
55.0	14.75	2.34
60.0	12.30	2.57
65.0	10.32	2.79
70.0	8.70	3.00
75.0	7.36	3.19
80.0	6.27	3.37
85.0	5.36	3.54
90.0	4.60	3.69
95.0	3.96	3.83
100.0	3.43	3.96
105.0	2.98	4.07
110.0	2.60	4.17
115.0	2.27	4.26
120.0	2.00	4.33

■ Compressor temperature thermistor

Temperature (°C)	Resistance (kΩ)	Voltage (V)
-30.0	1,013.11	0.06
-25.0	729.09	0.09
-20.0	531.56	0.12
-15.0	392.31	0.16
-10.0	292.91	0.21
-5.0	221.09	0.28
0.0	168.60	0.36
5.0	129.84	0.46
10.0	100.91	0.57
15.0	79.12	0.71
20.0	62.55	0.86
25.0	49.84	1.03
30.0	40.01	1.23
35.0	32.35	1.43
40.0	26.34	1.65
45.0	21.58	1.88
50.0	17.79	2.11
55.0	14.75	2.34
60.0	12.30	2.57
65.0	10.32	2.79
70.0	8.70	3.00
75.0	7.36	3.19
80.0	6.27	3.37
85.0	5.36	3.54
90.0	4.60	3.69
95.0	3.96	3.83
100.0	3.43	3.96
105.0	2.98	4.07
110.0	2.60	4.17
115.0	2.27	4.26
120.0	2.00	4.33

■ Heat exchanger temperature thermistor

Temperature (°C)	Resistance (kΩ)	Voltage (V)
-30.0	95.58	0.24
-25.0	68.90	0.32
-20.0	50.31	0.43
-15.0	37.19	0.57
-10.0	27.81	0.73
-5.0	21.02	0.92
0.0	16.05	1.14
5.0	12.38	1.39
10.0	9.63	1.65
15.0	7.56	1.93
20.0	5.98	2.21
25.0	4.77	2.49
30.0	3.84	2.77
35.0	3.11	3.02
40.0	2.53	3.26
45.0	2.08	3.48
50.0	1.71	3.68
55.0	1.42	3.85
60.0	1.19	4.00
65.0	1.00	4.13
70.0	0.84	4.25
75.0	0.71	4.35
80.0	0.61	4.43

■ Outdoor temperature thermistor

Temperature (°C)	Resistance (kΩ)	Voltage (V)
-30.0	224.33	0.73
-25.0	159.71	0.97
-20.0	115.24	1.25
-15.0	84.21	1.56
-10.0	62.28	1.90
-5.0	46.58	2.26
0.0	35.21	2.61
5.0	26.88	2.94
10.0	20.72	3.25
15.0	16.12	3.52
20.0	12.64	3.76
25.0	10.00	3.97
30.0	7.97	4.14
35.0	6.40	4.28
40.0	5.18	4.41
45.0	4.21	4.51
50.0	3.45	4.59
55.0	2.85	4.65

4. CONTROL AND FUNCTIONS

CONTENTS

4. CONTROL AND FUNCTIONS

1. Rotation number control of compressor.....	04-1
1-1. Cooling operation	04-1
1-2. Heating operation	04-2
1-3. Dry operation	04-2
1-4. Rotation number of compressor at normal start-up	04-3
1-5. Rotation number of compressor limitation by outdoor temperature	04-4
2. Auto changeover operation.....	04-6
3. Fan control.....	04-8
3-1. Indoor fan control.....	04-8
3-2. Outdoor fan control	04-10
4. Timer operation control	04-11
4-1. Wireless remote control	04-11
4-2. Wired remote control	04-13
5. Defrost operation control	04-16
5-1. Defrost operation in heating operation stopped	04-17
6. Various control	04-18
6-1. Auto restart	04-18
6-2. 10 °C HEAT operation	04-18
6-3. ECONOMY operation	04-18
6-4. Fresh air control.....	04-18
6-5. Compressor preheating	04-19
6-6. External electrical heater control	04-19
6-7. Electronic expansion valve control	04-19
6-8. Drain pump control	04-20
6-9. Prevention to restart for 3 minutes (3 minutes st)	04-22
6-10. 4-way valve control	04-22
6-11. Peak cut operation	04-22
6-12. Outdoor unit low noise operation	04-23
6-13. Unit status monitoring and the detected value indication	04-24
7. Various protections.....	04-28
7-1. Discharge gas temperature over-rise prevention control	04-28
7-2. Anti-freezing control (cooling and dry mode)	04-28
7-3. Current release control	04-29
7-4. Indoor unit fan motor over temperature protection.....	04-29
7-5. Compressor temperature protection	04-30
7-6. High pressure protection	04-30
7-7. Low outdoor temperature protection.....	04-30
7-8. High temperature and high pressure release control	04-31

1. Rotation number control of compressor

1-1. Cooling operation

A sensor (room temperature thermistor) built in the indoor unit body will usually perceive difference or variation between a set temperature and present room temperature, and controls the operation rotation number of the compressor.

- If the room temperature is 6.0 °C higher than a set temperature, the operation rotation number of compressor will attain to maximum performance.
- If the room temperature is 1.0 °C lower than a set temperature, the compressor will be stopped.
- When the room temperature is within the range of +6.0°C to -1.0°C of the setting temperature, the rotation number of compressor is controlled within the range shown in the table below. However, the maximum rotation number is limited in the range shown in the figure below based on the indoor fan mode and the outdoor temperature.

• Rotation number range of compressor

Model name	Minimum frequency	Maximum frequency
ARXG45KHTB ARXG54KHTB	17 rps	86 rps

• Limit of maximum speed based on outdoor temperature

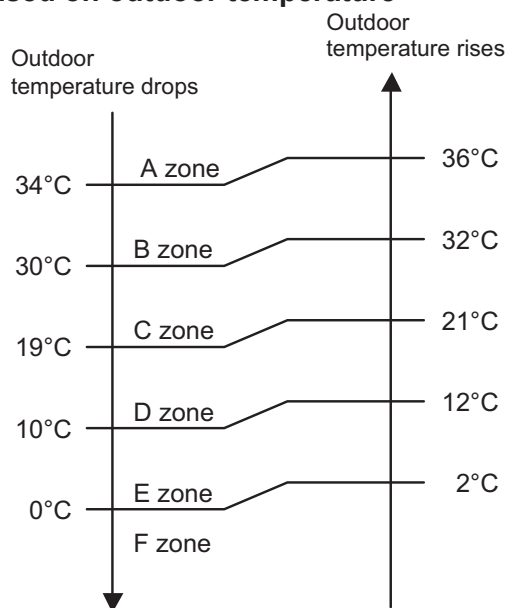

Unit: rps

Model name	Outdoor temperature zone	Indoor unit fan mode			
		HIGH	MED	LOW	QUIET
ARXG45KHTB ARXG54KHTB	A zone	86	80	71	56
	B zone	86	80	71	56
	C zone	75	66	56	41
	D zone	56	51	46	38
	E zone	56	51	46	38
	F zone	56	51	46	38

1-2. Heating operation

A sensor (room temperature thermistor) built in indoor unit body will usually perceive difference or variation between setting temperature and present room temperature, and controls operation rotation number of compressor.

- If the room temperature is 6.0 °C lower than a set temperature, the operation rotation number of compressor will attain to maximum performance.
- If the room temperature is 1.0 °C higher than a set temperature, the compressor will be stopped.
- When the room temperature is within the range of +1.0°C to -6.0°C of the setting temperature, the rotation number of compressor is controlled within the range shown below.

- **Rotation number range of compressor**

Unit: rps

Model name	Minimum frequency	Maximum frequency
ARXG45KHTB ARXG54KHTB	17	120

1-3. Dry operation

The rotation number of compressor shall change according to the temperature, set temperature, and room temperature variation which the room temperature sensor of the indoor unit has detected as shown in the table below.

Zone is defined by set temperature and room temperature.

- **Rotation number range of compressor**

Unit: rps

Model name	Outdoor temperature zone	Operating frequency
ARXG45KHTB ARXG54KHTB	X zone	33
	J zone	33
	Y zone	0

- **Compressor control based on room temperature**

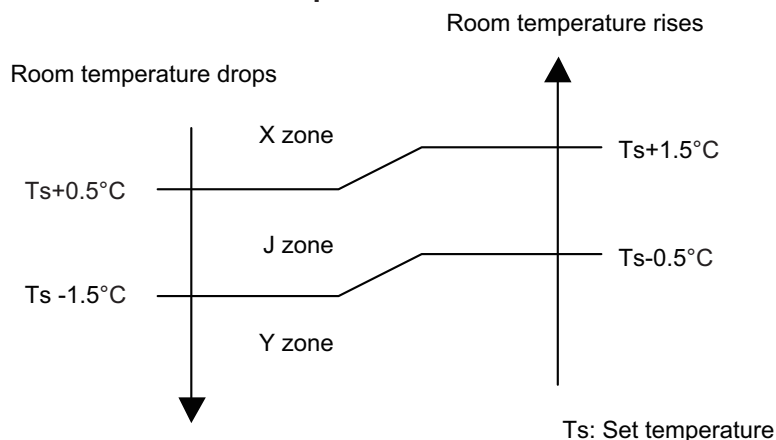

1-4. Rotation number of compressor at normal start-up

Compressor frequency soon after starting is controlled as below.

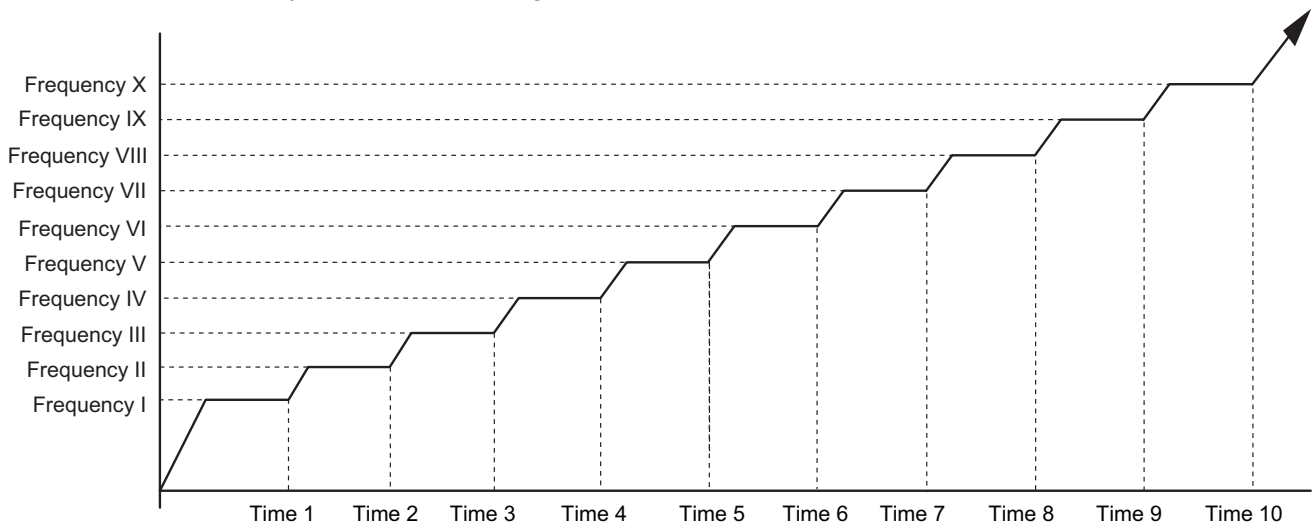

- Normal operation

Frequency (rps)	I 41	II 46	III 51	IV 57	V 60	VI 72	VII 81	VIII 91	IX 100	X 110
Time (sec)	1 60	2 120	3 180	4 240	5 360	6 420	7 480	8 540	9 600	10 660

- Special operation

Frequency (rps)	I 41	II 46	III 51	IV 57	V 60	VI 72	VII 81	VIII 91	IX 100	X 110
Time (sec)	1 120	2 185	3 245	4 305	5 605	6 665	7 725	8 785	9 845	10 1,000

NOTES:

- Normal operation:
 - Cooling and dry mode
 - Below 3 hours from the compressor stop and the compressor thermistor $\geq 15\text{ }^{\circ}\text{C}$
 - After defrost operation
 - Other than when the compressor starts for the first time since the breaker turns on
- Special operation:
 - Other than the normal operation condition
 - When the compressor starts for the first time since the breaker turns on

1-5. Rotation number of compressor limitation by outdoor temperature

The minimum rotation number of compressor is limited by outdoor temperature as below.

- **Cooling/Dry mode**

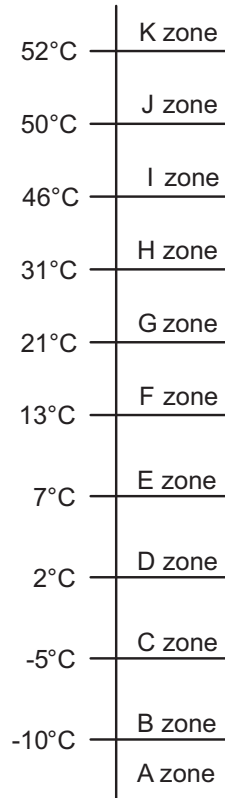

Model name	Outdoor temperature zone	Limitation of compressor frequency
AOYG45KRTA AOYG54KRTA	A zone	50 rps
	B zone	47 rps
	C zone	40 rps
	D zone	30 rps
	E zone	22 rps
	F zone	20 rps
	G zone	16 rps
	H zone	16 rps
	I zone	17 rps
	J zone	23 rps
	K zone	28 rps

- Heating mode

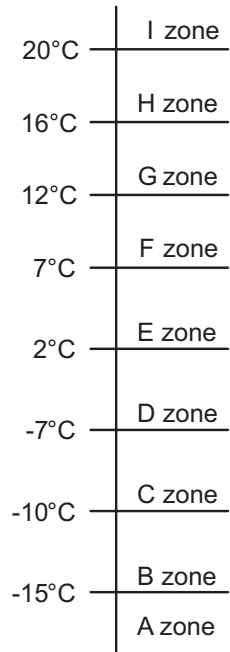

Model name	Outdoor temperature zone	Limitation of compressor frequency
AOYG45KRTA AOYG54KRTA	A zone	46 rps
	B zone	42 rps
	C zone	35 rps
	D zone	32 rps
	E zone	23 rps
	F zone	20 rps
	G zone	17 rps
	H zone	13 rps
	I zone	16 rps

2. Auto changeover operation

When the air conditioner is set to AUTO mode by remote controller, operation starts in the optimum mode from among heating, cooling, dry and monitoring modes. During operation, the optimum mode is automatically switched in accordance with temperature changes. The temperature can be set between 18°C and 30°C in 1.0°C steps.

- When operation starts, indoor fan and outdoor fan are operated for around 1 minute. Room temperature and outdoor temperature are sensed, and the operation mode is selected in accordance with the table below.

Room temperature	Operation mode
$Tr > Ts + 2^{\circ}\text{C}$	Cooling
$Ts + 2^{\circ}\text{C} \geq Tr \geq Ts - 2^{\circ}\text{C}$	Middle zone
$Tr < Ts - 2^{\circ}\text{C}$	Heating

Tr: Room temperature

Ts: Setting temperature

NOTE: When the operation mode is middle zone, indoor unit operation mode is selected as below.

- Same operation mode is selected as outdoor unit.
If outdoor unit is operating in cooling and heating mode, indoor unit will be operated by the same operation mode.
- Selected by outdoor temperature.
If outdoor unit is operating in other than cooling and heating mode, indoor unit will be operated according to the outdoor temperature as below.

Outdoor temp.	Operation mode
25°C or more	Cooling
Less than 25°C	Heating

- When the compressor was stopped for 6 consecutive minutes by temperature control function after the cooling or heating mode was selected as above, operation is switched to monitoring mode and the operation mode selection is done again.
- When the middle zone is selected on the predetermining of the operation mode, the operation mode before the changing to the monitoring mode is selected.

Operation flow chart

Ts: Setting temperature

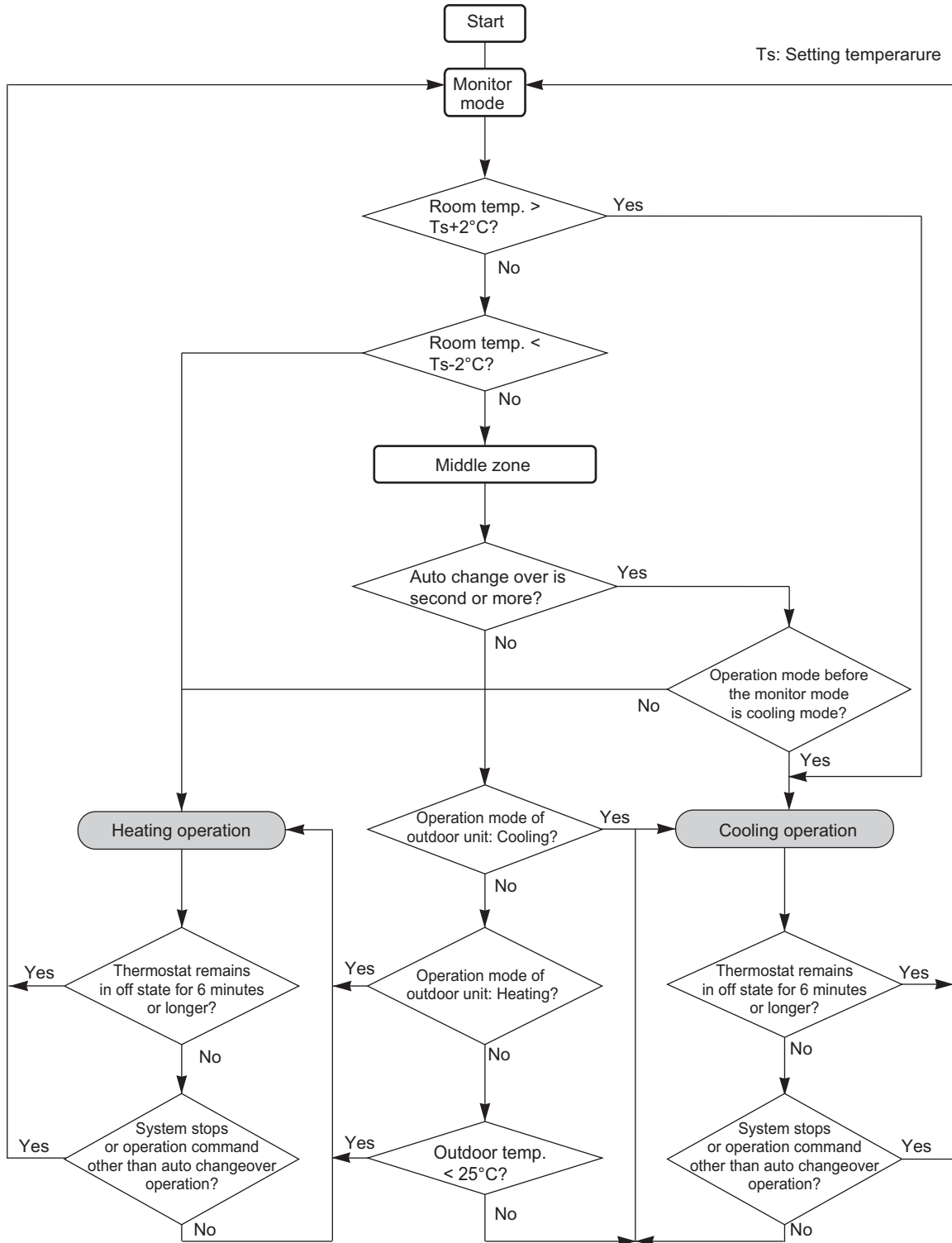

CONTROL AND FUNCTIONS

CONTROL AND FUNCTIONS

3. Fan control

Tr: Room temperature

Ts: Setting temperature

3-1. Indoor fan control

■ Fan operation

Airflow can be switched in 5 steps such as AUTO, QUIET, LOW, MED, HIGH while indoor unit fan only runs.

When fan mode is set at AUTO, it operates on MED fan speed.

■ Cooling operation

Switch the airflow AUTO, and indoor fan motor will run according to room temperature, as below.

On the other hand, if switched in HIGH—QUIET, indoor motor will run at a constant airflow of COOL operation modes QUIET, LOW, MED, HIGH as shown in “Fan speed” above.

Airflow change over (Cooling: Auto)

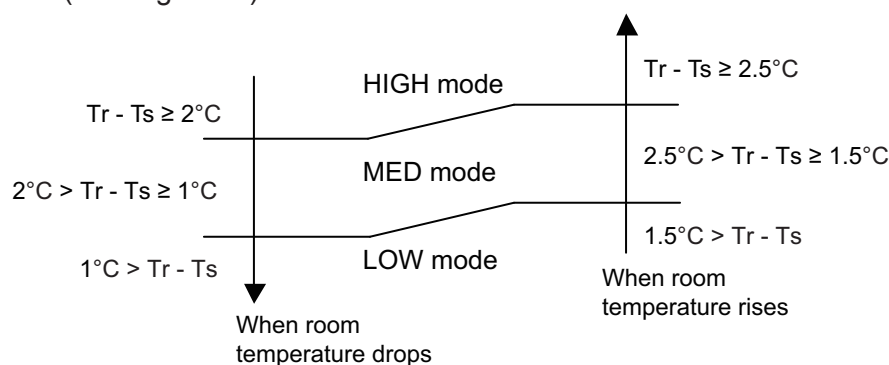

■ Dry operation

During dry operation, fan speed setting can not be changed.

■ Heating operation

Switch the airflow AUTO, and the indoor fan motor will run according to a room temperature, as below.

On the other hand, if switched in HIGH—QUIET, the indoor motor will run at a constant airflow of HEAT operation modes QUIET, LOW, MED, HIGH as shown in “Fan speed” above.

Airflow change over (Heating: Auto)

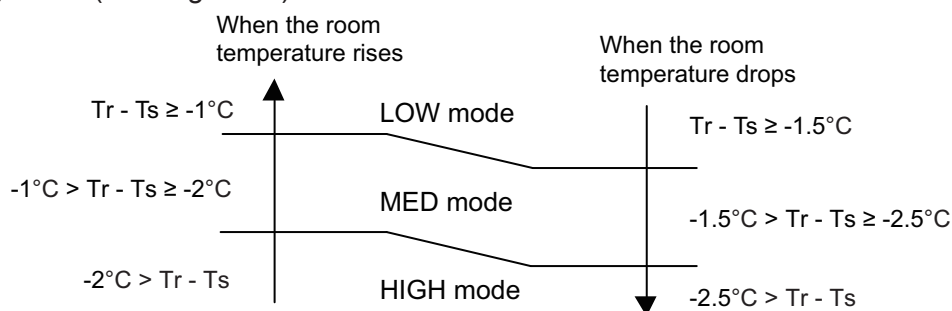

■ Cool air prevention control (heating mode)

The maximum value of the indoor fan speed is set as shown below, based on the detected temperature by the indoor heat exchanger sensor on heating mode.

- Normal operation

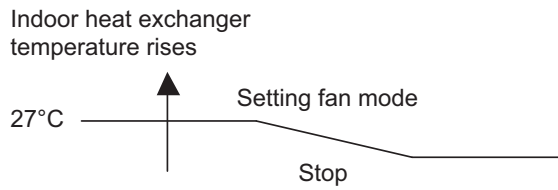

13 minutes later:

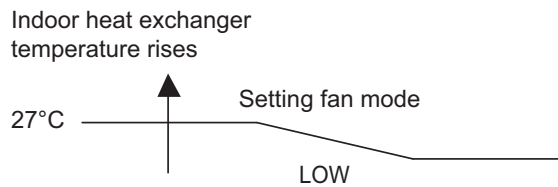

- 10 °C HEAT operation

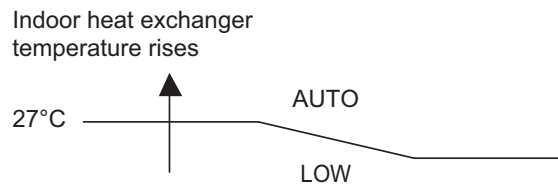

■ Moisture return prevention control (cooling and dry mode)

Switch the airflow AUTO at cooling mode, and the indoor fan motor will run as shown below.

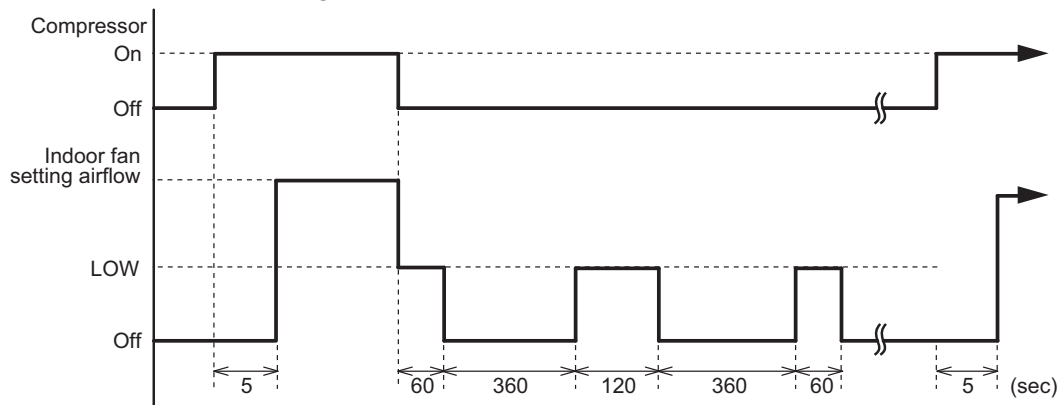

CONTROL AND FUNCTIONS

CONTROL AND FUNCTIONS

3-2. Outdoor fan control

■ Outdoor fan motor

This outdoor unit has a DC fan motor. (Control method is different between AC and DC motors.)

■ Fan speed

Fan speed is defined by outdoor temperature and compressor frequency.

Unit: rpm

Fan step	Cooling or dry	Heating
13	990	—
12	920	—
11	860	—
10	800	990
9	740	900
8	650	820
7	600	740
6	530	650
5	490	540
4	400	460
3	330	380
2	270	290
1	200	200
S-HIGH	—	990

- When the compressor frequency increases, the outdoor fan speed also changes to the higher speed.
- When the compressor frequency decreases, the outdoor fan speed also changes to the lower speed.

NOTE: After defrost control on the heating mode, the fan speed is kept higher regardless of the compressor frequency.

Fan speed after defrost control: 990 rpm

4. Timer operation control

4-1. Wireless remote control

On/Off timer	Program timer	Sleep timer	Weekly timer
○	○	○	—

■ On/Off timer

- Off timer: When the clock reaches the set timer, the air conditioner will be turned off.

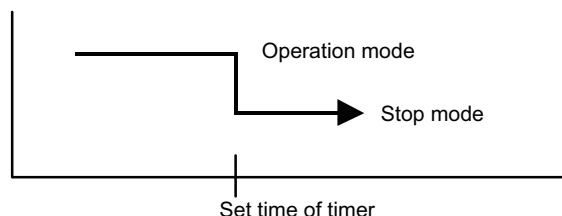

- On timer: When the clock reaches the set timer, the air conditioner will be turned on.

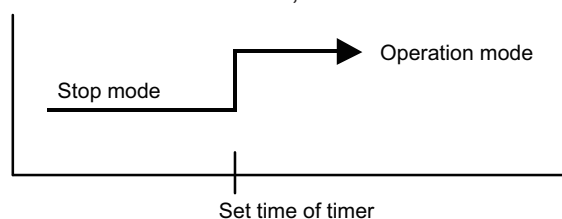

■ Program timer

- The program timer allows the off timer and the on timer to be used in combination one time.

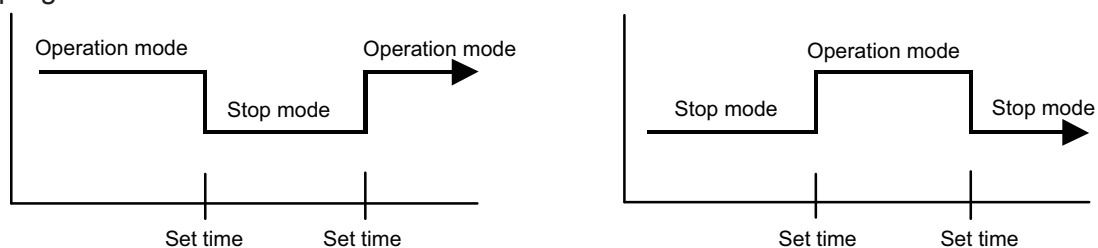

- Operation will start from the timer setting (either off timer and on timer) whichever is closest to the clock current timer setting. The order of operations is indicated by the allow in the remote controller screen.
- Sleep timer operation cannot be combined with on timer operation.

■ Sleep timer

If the sleep timer is set, the room temperature is monitored and the operation is stopped automatically. If the operation mode or the set temperature is change after the sleep timer is set, the operation is continued according to the changed setting of the sleep timer from that time on.

- In the cooling operation mode

When the sleep timer is set, the setting temperature is increased 1°C . It increases the setting temperature another 1°C after 1 hour. After that, the setting temperature is not changed and the operation is stopped at the setting time.

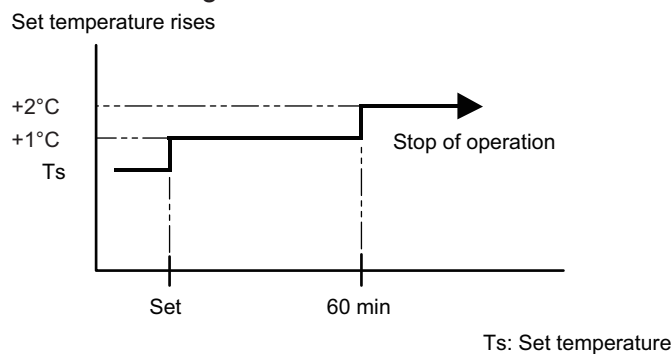

- In the heating operation mode

When the sleep timer is set, the setting temperature is decreased 1°C . It decreases the setting temperature another 1°C every 30 minutes. Upon lowering 4°C , the setting temperature is not changed and the operation is stopped at the setting time.

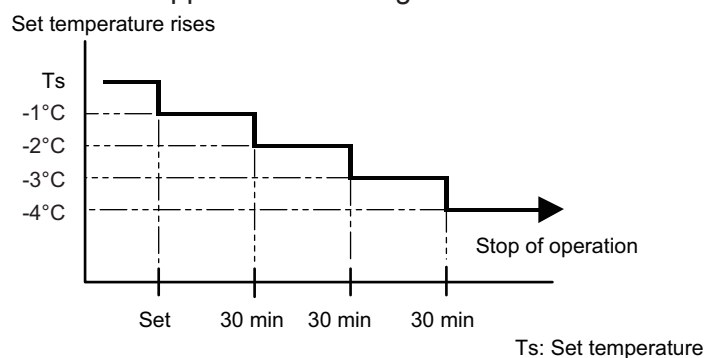

4-2. Wired remote control

On/Off timer	Program timer	Sleep timer	Weekly timer	Temperature Setback Timer
○	○	○	○	○

■ On/Off timer

- Off timer: When the clock reaches the set timer, the air conditioner will be turned off.

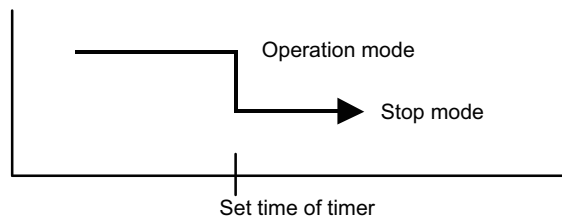

- On timer: When the clock reaches the set timer, the air conditioner will be turned on.

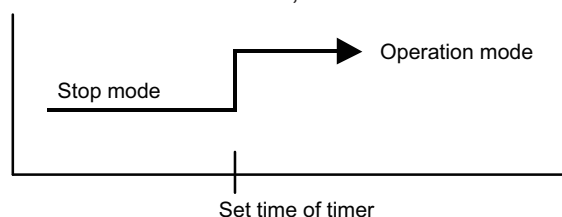

■ Program timer

- The program timer allows the off timer and the on timer to be used in combination one time.

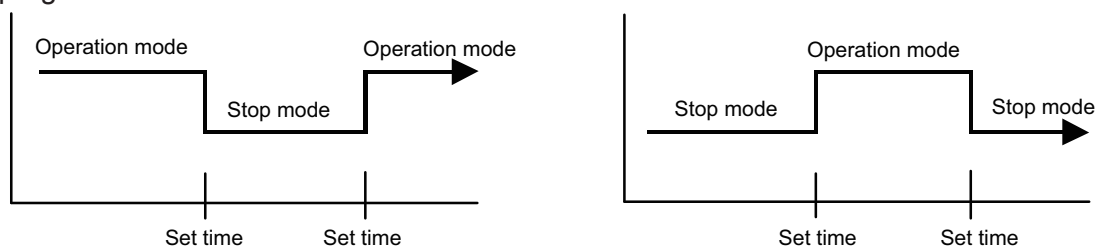

- Operation will start from the timer setting (either off timer and on timer) whichever is closest to the clock current timer setting. The order of operations is indicated by the allow in the remote controller screen.
- Sleep timer operation cannot be combined with on timer operation.

■ Sleep timer

If the sleep timer is set, the room temperature is monitored and the operation is stopped automatically. If the operation mode or the set temperature is change after the sleep timer is set, the operation is continued according to the changed setting of the sleep timer from that time on.

- In the cooling operation mode

When the sleep timer is set, the setting temperature is increased 1°C. It increases the setting temperature another 1°C after 1 hour. After that, the setting temperature is not changed and the operation is stopped at the setting time.

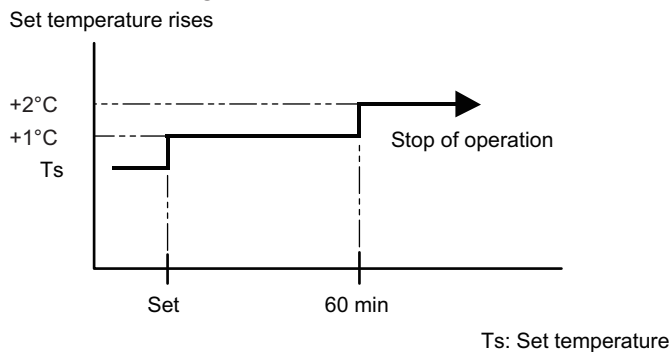

- In the heating operation mode

When the sleep timer is set, the setting temperature is decreased 1°C. It decreases the setting temperature another 1°C every 30 minutes. Upon lowering 4°C, the setting temperature is not changed and the operation is stopped at the setting time.

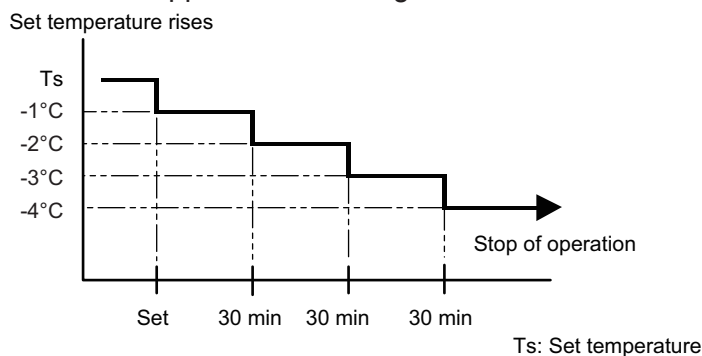

■ Weekly timer

On and off timer can be combined, and up to 4 reservations per day and 28 reservations per week. Before setting the program, set the week and time of the air conditioner at first. If the week and time are not set, the weekly timer will not operate correctly at the setting time.

■ Temperature Setback Timer

- The temperature setback timer only changes the set temperature for 7 days, it cannot be used to start or stop air conditioner operation.
- The temperature setback timer can be set to operate up to two times per day but only one temperature setting can be used.
- During COOLING/DRY mode, the air conditioner will operate at a minimum of 18°C even if the SET BACK temperature is set to 17°C or lower.

Case of Temperature Setback Timer on the Cooling operation. (Setting temperature :22°C, SET BACK temperature :26°C)

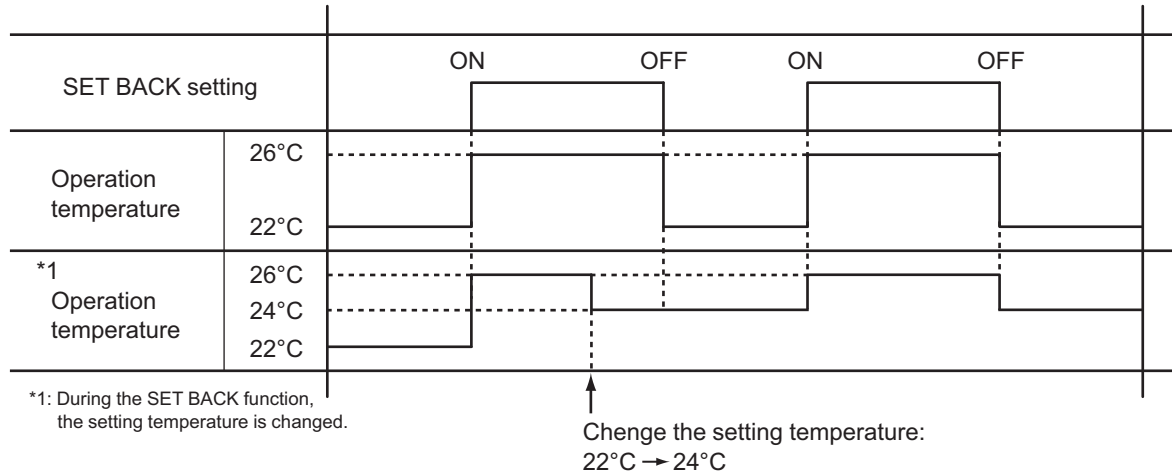

5. Defrost operation control

Tn: Outdoor unit heat exchanger temperature

Ta: Outdoor temperature

Tn10: Temperature at 10 minutes after compressor start

Tnb: Temperature before 5 minutes

• Triggering condition

The defrost operation starts when outdoor unit heat exchanger temperature sensor detects the temperature lower than the values shown below.

– 1st time defrosting after starting operation

Compressor integrating operation time	Less than 17 min.	17 to 57 min.	More than 57 min.
Condition	Does not operate	$T_n \leq -9^\circ\text{C}$ and $T_n - T_a \geq 5$ deg	$T_n \leq -5^\circ\text{C}$

– 2nd time and after

Compressor integrating operation time	Less than 35 min.	More than 35 min.
Condition	Does not operate	$T_n - T_{n10} < -5$ deg ($T_n \leq -10^\circ\text{C}$) $T_n - T_{nb} < -2$ deg ($T_n \leq -10^\circ\text{C}$) $T_n \leq -25^\circ\text{C}$ ($T_a \geq -20^\circ\text{C}$) $T_n \leq T_a - 7^\circ\text{C}$ or $T_n \leq -25^\circ\text{C}$ ($T_a < -20^\circ\text{C}$)

– Integrating defrost (Constant monitoring)

Compressor integrating operation time	More than 240 min. (For long continuous operation)	More than 215 min. (For long continuous operation)	Less than 10 min.* (For intermittent operation)
Condition	$T_n \leq -3^\circ\text{C}$	$T_n \leq -5^\circ\text{C}$	Count of the compressor off: 40 times

*: If the compressor continuous operation time is less than 10 minutes, the number of the compressor off is counted. If any defrost operated, the compressor off count is cleared.

• Release condition

The defrost operation is released when either one of the conditions below is satisfied.

Outdoor unit heat exchanger temperature (after 1 minute or later since compressor start)	12°C or more
Compressor operation time	15 minutes

5-1. Defrost operation in heating operation stopped

If the outdoor unit is frosted when stopping the heating operation, it stops after performing the automatic defrosting operation.

In this time, if the indoor unit operation lamp flashes slowly (6 sec on/2 sec off), the outdoor unit allow the heat exchanger to defrost, and then stop.

• Triggering condition

When all of the following conditions are satisfied in heating operation

- Compressor operation integrating time: 30 minutes or more
- Compressor continuous operation time: 10 minutes or more
- Outdoor unit heat exchanger temperature: -4°C or less

• Release condition

The defrost operation is released when either one of the conditions below is satisfied.

Outdoor unit heat exchanger temperature (after 1 minute or later since compressor start)	12°C or more
Compressor operation time	15 minutes

6. Various control

6-1. Auto restart

When the power was interrupted by a power failure etc. during operation, the operation contents at that time are memorized and when the power is recovered, operation is automatically started with the memorized operation contents.

Operation contents memorized when the power is interrupted	
Operation mode	
Setting temperature	
Fan mode setting	
Timer mode and set time (set by wireless remote controller)	
ECONOMY operation	
10 °C HEAT operation	
Outdoor low noise operation	

6-2. 10 °C HEAT operation

10 °C HEAT operation performs as below setting when pressing 10 °C HEAT button.

Operation mode	Heating
Setting temperature	10°C
Fan mode	AUTO
LED display	Economy
Defrost operation	Operate as normal

6-3. ECONOMY operation

The ECONOMY operation starts by pressing ECONOMY button on the remote controller.

The ECONOMY operation is almost the same operation as below settings.

Mode	Cooling/Dry	Heating
Target temperature	Setting temperature +1°C	Setting temperature -1°C

6-4. Fresh air control

The fan motor for Fresh Air is operated in synchronization with the indoor fan operation as below.

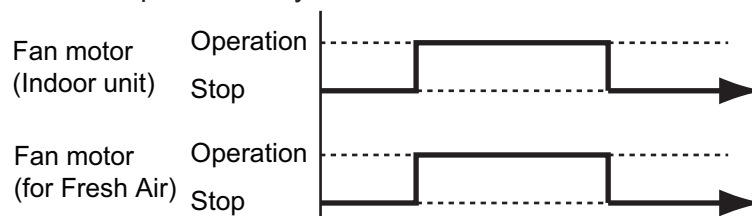

6-5. Compressor preheating

By preheating the compressor, warm airflow is quickly discharged when the operation is started.

- **Triggering condition 1**

- Outdoor temperature $\leq 20^{\circ}\text{C}$

When outdoor temperature reaches 26°C , compressor preheating stops.

- 30 minutes after compressor stopped

- **Triggering condition 2**

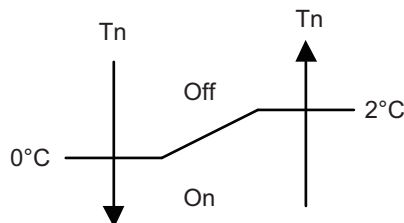

Tn: Outdoor unit heat exchanger temp.

6-6. External electrical heater control

The external electrical heater is operated as below.

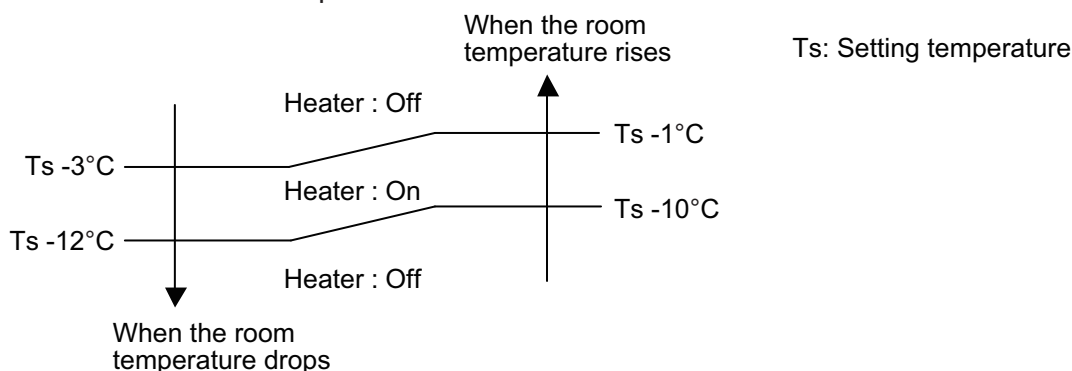

NOTES:

- When the compressor stop, external electric heater is off.
- It operates only in heating mode and when the indoor fan operates. (However, S-LOW is excluded.)

6-7. Electronic expansion valve control

The most proper opening of the electronic expansion valve is calculated and controlled under the present operating condition based on the table below.

Operation mode	Pulse range
Cooling/dry mode	Between 47 and 480 pulses
Heating mode	Between 39 and 480 pulses

NOTE: At the time of supplying the power to the outdoor unit, the initialization of the electronic expansion valve is operated (528 pulses are input to the closing direction).

6-8. Drain pump control

■ Drain control for cooling operation

● During the compressor in operation

- **Triggering condition**
The thermostat is turned on during cooling or dry mode.
- **Operation details**
The drain pump is turned on.
- **Release condition**
 - The thermostat is turned off.
Refer to "When the compressor is not in operation" for the operation after release.
 - The compressor is stopped.
Refer to "When the compressor is not in operation" for the operation after release.
 - The operation is switched to heating mode.
Refer to "When the compressor is not in operation" for the operation after release.
 - The float switch is turned on.
Refer to "Overflow control" for the operation after release.
 - The compressor is stopped by Anti-freezing control.
Refer to "The compressor is stopped by Anti-freezing control" for the operation after release.

● When the compressor is not in operation

- **Triggering condition**
 - The thermostat is turned off.
 - The compressor is stopped.
 - The operation is switched to heating mode.
 - The float switch is turned off.
- **Operation details**
 - Count 180 minutes.
 - Start drain pump intermittent operation.

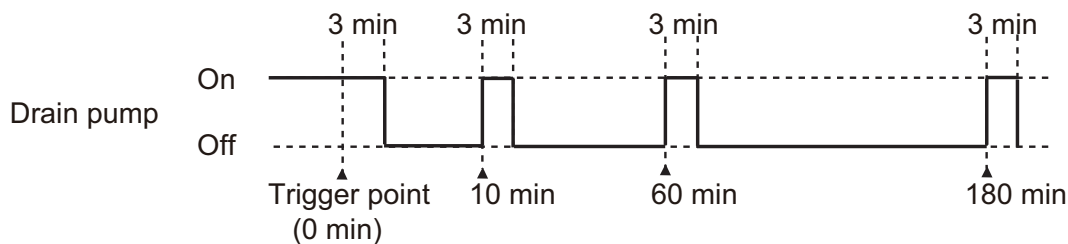

- **Release condition**
 - 3 minutes drain pump operation is finished after 180 minutes count.
 - The operation is switched to cooling or dry mode.
Refer to "During the compressor in operation" for the operation after release.
 - The float switch is turned on.
Refer to "Overflow control" for the operation after release.
- **Operation after release**
The drain pump is turned off and the air conditioner operate according the settings.

● Overflow control

- **Triggering condition**

The float switch is turned on.

- **Operation details**

- The drain pump is turned on.
- When the operation mode is cooling or dry, operate the followings.
 - The compressor is stopped.
 - Then indoor fan control is turned off.

- **Release condition**

- The float switch is turned off.
 - In the case that on the cooling or dry mode the thermostat is on, refer to "[During the compressor in operation](#)" for the operation after release.
 - In other case, refer to "[When the compressor is not in operation](#)" for the operation after release.
- 3 minutes passed

- **Operation after release**

The compressor stopps permanently.

● The compressor is stopped by Anti-freezing control

- **Triggering condition**

During the compressor in operation, the compressor is stopped by Anti-freezing control.

- **Operation details**

The drain pump is kept on in 60 minutes after Anti-freezing control released.

- **Release condition**

60 minutes passed

- **Operation after release**

According to the settings, operate the followings.

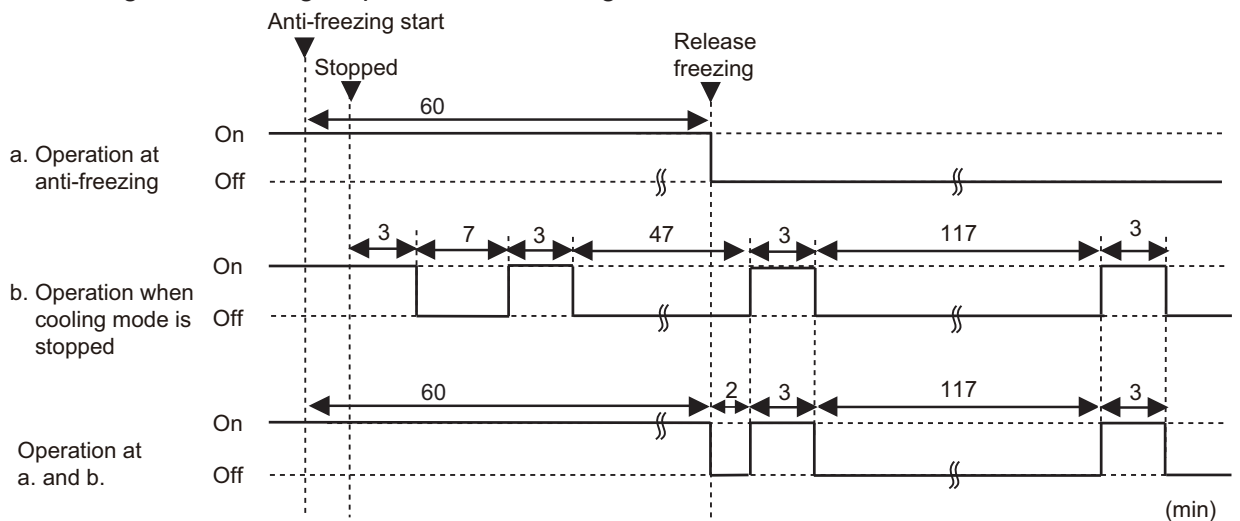

6-9. Prevention to restart for 3 minutes (3 minutes st)

When the compressor fails to start for the number of times below, it does not enter operation status for 3 minutes.

Retry number	30
Retry set number	3

When the compressor fails to start in the retry set number above, the compressor is stopped.

6-10. 4-way valve control

- If heating mode is selected at the compressor start, 4-way valve is energized for heating.
- When the air conditioner is switched between cooling and heating mode, compressor is stopped, and the 4-way valve is switched when the 3 minutes passes and the compressor is started.

6-11. Peak cut operation

The current value is limited to reduce the power consumption by external input.

Peak cut level	Level 1	Level 2	Level 3	Level 4
Peak cut for rated capacity	Forced thermostat off	50%	75%	100%

NOTES:

- During defrost operation, peak cut operation becomes invalid.
- Even during the peak cut operation, the operations of current overload, economy, and low noise are effective and the outdoor unit operates by lowest current of them.

6-12. Outdoor unit low noise operation

The compressor frequency and outdoor unit fan speed are limited to reduce the operation noise by external input.

Low noise mode	Low noise mode		Outdoor fan speed	Compressor frequency
			rpm	rps
AOYG45KRTA AOYG54KRTA	Level 1	Cooling/Dry	740	60
		Heating		
	Level 2	Cooling/Dry	740	40
		Heating		

NOTES:

- During the defrost operation, the compressor operates by the speed for defrost operation.
- Even during the low noise operation, the operations of current overload, economy, and peak cut are effective and the outdoor unit operates by lowest current of them.

Capacity priority mode

- Operation condition
The function setting is set to 1.
- Capacity check condition
 - Shortage: Compressor frequency > limited compressor frequency for low noise mode
 - Enough: Compressor frequency ≤ limited compressor frequency for low noise mode
- Operation
When detecting the shortage capacity or enough capacity condition continuous 30 minutes, the mode is changed as follows:
 - Automatic switching 1 (Level 1 setting)

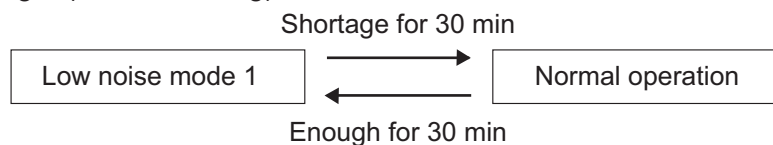

- Automatic switching 2 (Level 2 setting)

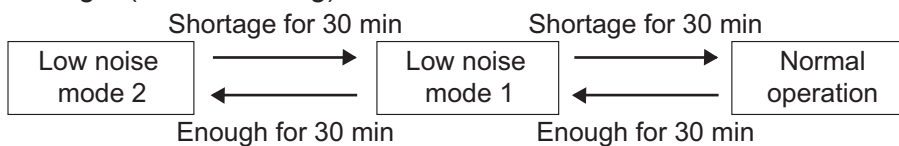

6-13. Unit status monitoring and the detected value indication

The wired remote controller can monitor the indoor and outdoor units' status and display the detected result as a relevant ID.

For details of the display method, refer to the Chapter of "Display Sensor Values" in the *Installation Manual* of Wired Remote Controller (Touch Panel).

The status can be monitored and displayed on the wired remote controller by assigning an arbitrary ID. For available ID list, refer to the table below.

NOTE: Operating time for each part cannot be reset when the part is replaced. Take notes of the operating time before replacing to count the operating time of the replaced part.

Available Sensor ID				
Sensor ID		Item	Unit	Remarks
00: Indoor unit				
00	000	Suction temp.	01: °C or °F	
00	001	Room temp.	01: °C or °F	When the wired remote controller thermistor is enabled, temperature of the wired remote controller thermistor is displayed.
00	002	Wired remote controller detected temp.	01: °C or °F	
00	003	Wireless remote controller detected temp.	01: °C or °F	Temperature detected by wireless remote controller
00	004	Discharge air temp.	01: °C or °F	
00	005	Heat exchanger inlet temp.	01: °C or °F	
00	006	Heat exchanger middle temp.	01: °C or °F	
00	007	Heat exchanger outlet temp.	01: °C or °F	
00	020	Fan rotation number	03: rpm	
00	021	Fan 2 rotation number	03: rpm	
00	022	Fan 3 rotation number	03: rpm	
00	030	Expansion valve	05: pls	
00	040	Operating pulse for right filter	05: pls	
00	041	Operating pulse for left filter	05: pls	
00	042	Operating pulse for filter brush	05: pls	
00	050	Power relay for outdoor unit On/Off	08: On/Off	0: Off, 1: On
00	051	Float switch On/Off	08: On/Off	0: Off, 1: On (When the water level rises)
00	052	Drain pump On/Off	08: On/Off	0: Off, 1: On
00	053	Solenoid valve for reheat operation On/Off	08: On/Off	0: Off (Opened), 1: On (Closed)
00	054	Air cleaner status On/Off	08: On/Off	0: Off, 1: On
00	055	Limit switch 1 (For grille) On/Off	08: On/Off	0: Off, 1: On
00	056	Limit switch 2 (For right filter) On/Off	08: On/Off	0: Off, 1: On
00	057	Limit switch 3 (For left filter) On/Off	08: On/Off	0: Off, 1: On
00	070	Current sensor	09: A	
00	080	Indoor unit total energized hours	11: h	
00	081	Total filtering hours	11: h	
00	082	Indoor unit fan total operation hours	11: h	
00	083	Indoor unit fan 2 total operation hours	11: h	
00	084	Indoor unit fan 3 total operation hours	11: h	
00	090	Temperature sensor	12: %	
00	095	Presence or absence detected by human sensor	00: —	0: Absence, 1: Presence —: Human sensor error or No human sensor

Available Sensor ID				
Sensor ID		Item	Unit	Remarks
00	140	Operation or Stop (External input)	00: —	0: Off, 1: On —: When the function setting 46 is not set NOTE: Available only for external input port of the indoor unit
00	141	Emergency stop (External input)	00: —	0: Off, 1: On —: When the function setting 46 is not set NOTE: Available only for external input port of the indoor unit
00	142	Forced stop (External input)	00: —	0: Off, 1: On —: When the function setting 46 is not set NOTE: Available only for external input port of the indoor unit
00	143	Operation or Stop 2 (External input)	00: —	0: Off, 1: On —: When the function setting 46 is not set NOTE: Available only for external input port of the indoor unit
00	144	External thermostat off (External input)	00: —	0: Off, 1: On
00	145	Cooling operation on (External input)	00: —	0: Off, 1: On
00	146	Cooling operation off (External output)	00: —	0: Off, 1: On NOTE: The value is output even if the function setting or rotary switch is not set.
00	155	Operation or Stop On/Off (External output)	00: —	0: Off, 1: On NOTE: The value is output even if the function setting or rotary switch is not set.
00	156	Error On/Off (External output)	00: —	0: Off, 1: On NOTE: The value is output even if the function setting or rotary switch is not set.
00	157	Indoor unit fan interlocking On/Off (External output)	00: —	0: Off, 1: On NOTE: The value is output even if the function setting or rotary switch is not set.
00	158	Cooling thermostat On/Off (External output)	00: —	0: Off, 1: On NOTE: The value is output even if the function setting or rotary switch is not set.
00	159	Requested cooling strength On/Off (External output)	00: —	0: Off, 1: On NOTE: The value is output even if the function setting or rotary switch is not set.
00	160	External heater On/Off (External output)	00: —	0: Off, 1: On NOTE: The value is output even if the function setting or rotary switch is not set.
00	161	Heating operation status (External output)	00: —	0: Off, 1: On NOTE: The value is output even if the function setting or rotary switch is not set.

Available Sensor ID				
Sensor ID		Item	Unit	Remarks
00	162	External output command by remote controller (External output)	00: —	0: Off, 1: On NOTE: The value is output even if the function setting or rotary switch is not set.
00	163	Set-point temp. not reached in server room function On/Off (External output)	00: —	0: Off, 1: On NOTE: The value is output even if the function setting or rotary switch is not set.
00	174	Anti-freeze protection On/Off	00: —	0: Off, 1: On
01: Outdoor unit				
01	000	Outdoor temp.	01: °C or °F	
01	001	Discharge temp.	01: °C or °F	
01	002	Suction temp.	01: °C or °F	
01	003	Heat exchanger middle temp.	01: °C or °F	
01	004	Heat exchanger outlet temp.	01: °C or °F	
01	005	Liquid pipe temp. (Before expansion valve)	01: °C or °F	
01	006	Liquid pipe temp. 2 (After expansion valve)	01: °C or °F	
01	007	Compressor temp.	01: °C or °F	
01	008	Heat sink temp.	01: °C or °F	
01	009	Liquid pipe temp. 3 (Sub cool heat exchanger inlet)	01: °C or °F	
01	010	Liquid pipe temp. 4 (Sub cool heat exchanger outlet)	01: °C or °F	
01	011	2-way valve temp. (For multi-split type)	01: °C or °F	
01	012	3-way valve temp. (For multi-split type)	01: °C or °F	
01	040	Discharge pressure	02: MPa	
01	041	Suction pressure	02: MPa	
01	042	Gas pipe pressure for outdoor unit	02: MPa	
01	050	Fan 1 rotation number	03: rpm	
01	051	Fan 2 rotation number	03: rpm	
01	055	Compressor rotation number	04: rps	
01	060	Expansion valve (Upstream during heating)	05: pls	
01	061	Expansion valve 2 (Downstream during heating)	05: pls	
01	062	Expansion valve 3 (For sub cool heat exchanger)	05: pls	
01	063	Expansion valve 4 (For injection)	05: pls	
01	064	Expansion valve 5 (For multi-split type)	05: pls	
01	075	Solenoid valve (For injection)	06: Open/Close	0: Close, 1: Open
01	080	4-way valve output status	07: Cooling/ Heating	0: Cooling, 1: Heating
01	085	Pressure switch (High pressure)	08: On/Off	0: Off (Close), 1: On (Open)
01	086	Pressure switch (Low pressure)	08: On/Off	0: Off (Close), 1: On (Open)
01	088	Crankcase heater output On/Off	08: On/Off	0: Off, 1: On
01	089	Base pan heater output On/Off	08: On/Off	0: Off, 1: On
01	090	Belt heater output On/Off	08: On/Off	0: Off, 1: On
01	100	Operating current	09: A	
01	110	Outdoor unit total power-on hours	11: h	
01	111	Compressor total heating operation hours	11: h	

Available Sensor ID				
Sensor ID		Item	Unit	Remarks
01	112	Compressor total cooling operation hours	11: h	
01	113	Compressor total operation hours	11: h	
01	114	Outdoor unit fan 1 total operation hours	11: h	
01	115	Outdoor unit fan 2 total operating hours	11: h	
01	145	Outdoor low noise input (External input)	00: —	0: Off, 1: On
01	146	Outdoor peak cut (External input)	00: —	0: Off 1: Mode 4 (100%) 2: Mode 3 (75%) 3: Mode 2 (50%) 4: Mode 1 (Forced thermostat off)
01	147	Demand response (External input)	00: —	0: Normal, 1: DRM1, 2: DRM2, 3: DRM3
01	148	Switching cooling and heating mode (External input)	00: —	0: Cooling, 1: Heating
01	149	Emergency stop (External input)	00: —	0: Off, 1: On
01	155	Compressor status (External output)	00: —	0: Off, 1: On
01	156	Error status (External output)	00: —	0: Off, 1: On

7. Various protections

7-1. Discharge gas temperature over-rise prevention control

The discharge gas temperature sensor (discharge thermistor: outdoor unit side) detects the discharge gas temperature.

- When the discharge temperature becomes higher than the trigger condition, the compressor frequency is decreased as the table below, and it continues to decrease until the discharge temperature becomes lower than the trigger condition.
- When the discharge temperature becomes lower than the release condition, control of compressor frequency is released.
- When the discharge temperature becomes higher than the compressor protection temperature, the compressor is stopped and the indoor unit indicator lamp starts blinking.

Trigger condition	104°C
Compressor frequency	-14 rps/120 seconds
Release condition	101°C
Compressor protection temperature	110°C

7-2. Anti-freezing control (cooling and dry mode)

The rotation number of compressor is decrease in cooling and dry mode when the indoor unit heat exchanger temperature sensor detects the temperature lower than the trigger condition.

When the indoor unit heat exchanger temperature reaches release condition, the anti-freezing control is stopped.

Trigger condition	4°C	
Release condition	Outdoor temp. $\geq 10^{\circ}\text{C}^{*1}$	7°C
	Outdoor temp. $\geq 12^{\circ}\text{C}^{*2}$	
	Outdoor temp. $< 10^{\circ}\text{C}^{*1}$	13°C
	Outdoor temp. $< 12^{\circ}\text{C}^{*2}$	

*1: During the outdoor temperature dropping

*2: During the outdoor temperature rising

7-3. Current release control

The rotation number of compressor is controlled so that the outdoor unit input current does not exceeds current limit value set according to the outdoor temperature.

The rotation number of compressor returns according to the operation mode, when the current becomes lower than the release value.

■ Models: AOYG45KRTA and AOYG54KRTA

Operation mode	Outdoor temp. (Ta)	Trigger condition	Release condition
Cooling	$52^{\circ}\text{C} \leq \text{Ta}$	4.5 A	4.0 A
	$50^{\circ}\text{C} \leq \text{Ta} < 52^{\circ}\text{C}$	5.5 A	5.0 A
	$46^{\circ}\text{C} \leq \text{Ta} < 50^{\circ}\text{C}$	6.5 A	6.0 A
	$42^{\circ}\text{C} \leq \text{Ta} < 46^{\circ}\text{C}$	7.5 A	7.0 A
	$2^{\circ}\text{C} \leq \text{Ta} < 42^{\circ}\text{C}$	8.5 A	8.0 A
	$\text{Ta} < 2^{\circ}\text{C}$	10.0 A	9.5 A
Heating	$20^{\circ}\text{C} \leq \text{Ta}$	6.5 A	6.0 A
	$16^{\circ}\text{C} \leq \text{Ta} < 20^{\circ}\text{C}$	7.0 A	6.5 A
	$12^{\circ}\text{C} \leq \text{Ta} < 16^{\circ}\text{C}$	8.0 A	7.5 A
	$2^{\circ}\text{C} \leq \text{Ta} < 12^{\circ}\text{C}$	8.5 A	8.0 A
	$\text{Ta} < 2^{\circ}\text{C}$	10.0 A	9.5 A

7-4. Indoor unit fan motor over temperature protection

The fan motor over temperature protection activates after two judgments when fulfilling any of the following conditions.

- Detected that the rotation number of the fan motor stays 300 rpm or less for 10 seconds after 90 seconds from the fan operation started.
- IPM trip protection activates.
- Current overload protection activates.

At first, the function determines if any of the above conditions apply (First judgment). If any of the above conditions apply after the first judgment, the function will make the second judgment after 6 minutes. If any of the above conditions still apply in the second judgment, fan motor over temperature protection activates.

• Protection details

The function lowers the static pressure by 20 Pa. If the problem is not resolved even at the minimum static pressure, the unit operates as follows.

- Fan motor error will be displayed if the fan motor speed stays 300 rpm or less for 10 seconds after 90 seconds from the fan operation started.
- The fan stops 40 seconds after the activation of the IPM trip protection.
- The fan stops 50 seconds after the activation of the current overload protection.

7-5. Compressor temperature protection

When the compressor temperature sensor detects higher than the trigger condition below, the compressor is stopped. When the compressor temperature sensor detects the release condition, the protection is released.

Trigger condition	108°C
Release condition	80°C (3 minutes after compressor stop)

7-6. High pressure protection

Trigger condition	Pressure switch: Off (Open: Higher than 4.2 MPa) Compressor stop
Release condition	Pressure switch: On (Close: Lower than 3.2 MPa) (3 minutes after compressor stop) Compressor restart

7-7. Low outdoor temperature protection

When the outdoor temperature sensor detects lower than the trigger condition below, the compressor is stopped.

Operation mode	Cooling/Dry
Trigger condition	-20°C
Release condition	-15°C

7-8. High temperature and high pressure release control

The compressor is controlled as follows.

• Cooling mode

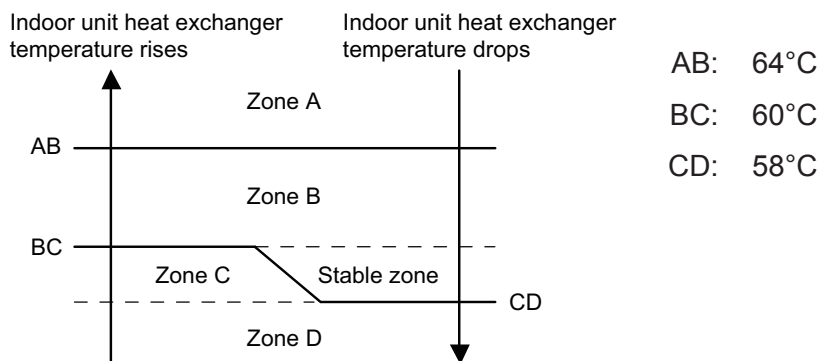

Zone	Operation	
Zone A	Compressor is stopped.	
Zone B	The compressor frequency is decreased.	-7 rps/120 sec.
Zone C	The protection is released and the operation is returned to normal mode.	
Zone D		

• Heating mode

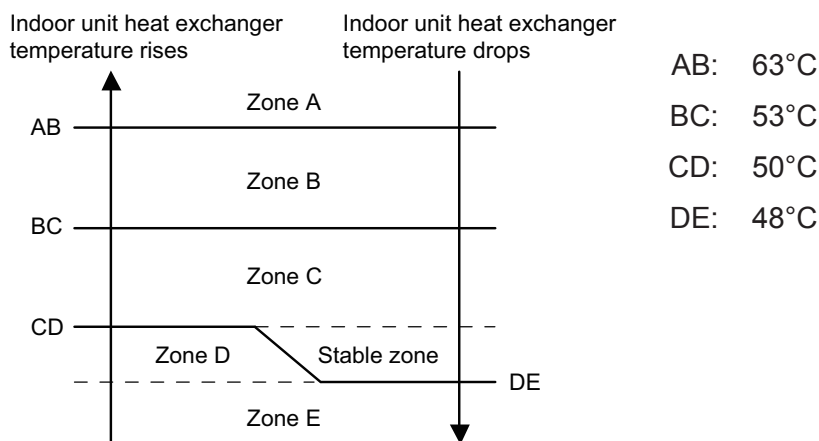

Zone	Operation	
Zone A	Compressor is stopped.	
Zone B	The compressor frequency is decreased.	-7 rps/120 sec.
Zone C		-1 rps/120 sec.
Zone D	The protection is released and the operation is returned to normal mode.	
Zone E		

5. FILED WORKING

CONTENTS

5. FILED WORKING

1. Function settings (For indoor unit)	05-1
1-1. Function settings on indoor unit.....	05-1
1-2. Function settings by using remote controller	05-2
2. Function settings (For outdoor unit)	05-7
2-1. Control PCB and switch buttons location.....	05-7
2-2. Local setting procedure	05-9
3. External input and output (For indoor unit)	05-11
3-1. External input.....	05-12
3-2. External output	05-14
3-3. Setting of external input and output	05-15
3-4. Details of control input function.....	05-16
3-5. Details of control output function	05-20
4. External input and output (For outdoor unit).....	05-23
4-1. External input.....	05-23
4-2. External output	05-25

1. Function settings (For indoor unit)

To adjust the functions of this product according to the installation environment, various types of function settings are available.

NOTE: Incorrect settings can cause a product malfunction.

1-1. Function settings on indoor unit

By using some components on the PCB, you can change the function settings.

■ Component location

Components on the indoor unit main PCB used for the function settings are located as shown in the following figure.

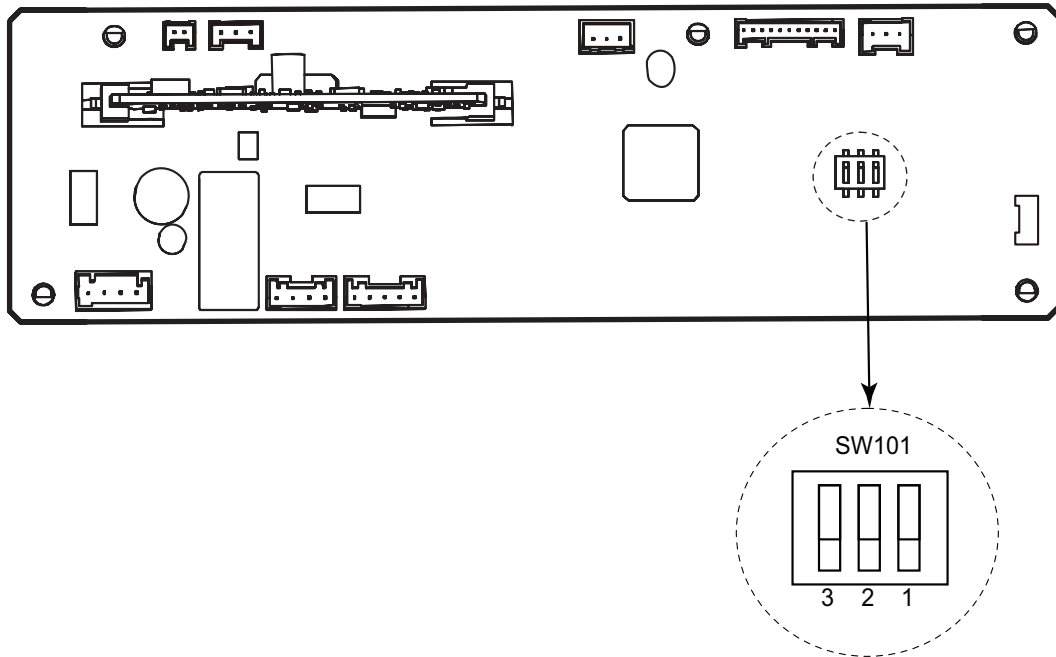

■ DIP switch setting

- **Switch 1: Drainage function setting (SW101)**

Switch 1	Drainage function	Factory setting
ON	Disabled	
OFF	Enabled	◆

- **Switch 2: Setting change prohibited (SW101)**

- **Switch 3: Fan delay setting (SW101)**

When the indoor unit is stopped while operating in conjunction with auxiliary heater, the indoor unit fan operation will continue for 1 minute.

Switch 3	Fan delay	Factory setting
ON	Enabled	
OFF	Disabled	◆

1-2. Function settings by using remote controller

Some function settings can be changed on the remote controller. After confirming the setting procedure and the content of each function setting, select appropriate functions for your installation environment.

■ Setting procedure by using remote controller

Remote controller is not attached for this product. For details of the installing remote controller, refer to following information.

- Overview information: Operating manual of the remote controller
- Setting procedure: Installation manual of the remote controller

■ Contents of function setting

Each function setting listed in this section is adjustable in accordance with the installation environment.

NOTE: Setting will not be changed if invalid numbers or setting values are selected.

● Function setting list

	Function no.	Functions
1)	11	Filter sign
2)	30/31	Room temperature control for indoor unit sensor
3)	35/36	Room temperature control for wired remote controller sensor
4)	40	Auto restart
5)	42	Room temperature sensor switching
6)	44	Remote controller custom code
7)	46	External input control
8)	48	Room temperature sensor switching (Aux.)
9)	49	Indoor unit fan control for energy saving for cooling
10)	60	Switching functions for external output terminal

1) Filter sign

Select appropriate intervals for displaying the filter sign on the indoor unit according to the estimated amount of dust in the air of the room.

If the indication is not required, select "No indication" (03).

Function number	Setting value	Setting description	Factory setting
11	00	Standard (2,500 hours)	
	01	Long interval (5,000 hours)	
	02	Short interval (1,250 hours)	
	03	No indication	◆

2) Room temperature control for indoor unit sensor

NOTE: If the remote sensor unit option is selected, perform this setting.

Depending on the installed environment, correction of the room temperature sensor may be required. Select the appropriate control setting according to the installed environment.

The temperature of the room temperature sensor is corrected as follows:

Corrected temp. = Temp. of the room temp. sensor - Correction temp. value

Example of correction:

When the temperature of the room temp. sensor is 26°C and the setting value is "03" (-1.0°C), corrected temp. will be 27°C (26°C - [-1.0°C]).

The temperature correction values show the difference from the Standard setting "00" (manufacturer's recommended value).

Function number		Setting value	Setting description	Factory setting	
30 (For cooling)	31 (For heating)	00	Standard setting	◆	
		01	No correction 0.0 °C		
		02	-0.5 °C	More cooling Less heating	
		03	-1.0 °C		
		04	-1.5 °C		
		05	-2.0 °C		
		06	-2.5 °C		
		07	-3.0 °C		
		08	-3.5 °C		
		09	-4.0 °C		
		10	+0.5 °C	Less cooling More heating	
		11	+1.0 °C		
		12	+1.5 °C		
		13	+2.0 °C		
		14	+2.5 °C		
		15	+3.0 °C		
		16	+3.5 °C		
17	+4.0 °C				

3) Room temperature control for wired remote controller sensor

Depending on the installed environment, correction of the wire remote temperature sensor may be required. Select the appropriate control setting according to the installed environment.

To change this setting, set Function 42 to Both "01".

Ensure that the Thermo Sensor icon is displayed on the remote controller screen.

Function number		Setting value	Setting description	Factory setting	
35 (For cooling)	36 (For heating)	00	Standard setting	◆	
		01	No correction 0.0°C		
		02	-0.5 °C	More cooling Less heating	
		03	-1.0 °C		
		04	-1.5 °C		
		05	-2.0 °C		
		06	-2.5 °C		
		07	-3.0 °C		
		08	-3.5 °C		
		09	-4.0 °C		
		10	+0.5 °C	Less cooling More heating	
		11	+1.0 °C		
		12	+1.5 °C		
		13	+2.0 °C		
		14	+2.5 °C		
		15	+3.0 °C		
		16	+3.5 °C		
17	+4.0 °C				

4) Auto restart

Enables or disables automatic restart after a power interruption.

Function number	Setting value	Setting description	Factory setting
40	00	Enable	◆
	01	Disable	

NOTE: Auto restart is an emergency function such as for power outage etc. Do not attempt to use this function in normal operation. Be sure to operate the unit by remote controller or external device.

5) Room temperature sensor switching

(Only for wired remote controller)

When using the wired remote controller temperature sensor, change the setting to "Both" (01).

Function number	Setting value	Setting description	Factory setting
42	00	Indoor unit	◆
	01	Both	

00: Sensor on the indoor unit is active.

01: Sensors on both indoor unit and wired remote controller are active.

NOTES:

- Remote controller sensor must be turned on by using the remote controller.
- When using the remote sensor unit, set to "00" or set to "01" and then select "indoor unit sensor" from wired remote controller.

6) Remote controller custom code

(Only for wireless remote controller)

The indoor unit custom code can be changed. Select the appropriate custom code.

Function number	Setting value	Setting description	Factory setting
44	00	A	◆
	01	B	
	02	C	
	03	D	

7) External input control

"Operation/Stop" mode or "Forced stop" mode can be selected.

Function number	Setting value	Setting description	Factory setting
46	00	Operation/Stop mode 1	◆
	01	(Setting prohibited)	
	02	Forced stop mode	
	03	Operation/Stop mode 2	

8) Room temperature sensor switching (Aux.)

To use the temperature sensor on the wired remote controller only, change the setting to "Wired remote controller" (01).

This function will only work if the function setting 42 is set at "Both" (01).

When the setting value is set to "Both" (00), more suitable control of the room temperature is possible by setting function setting 30 and 31 too.

Function number	Setting value	Setting description	Factory setting
48	00	Both	◆
	01	Wired remote controller	

9) Indoor unit fan control for energy saving for cooling

Enables or disables the power-saving function by controlling the indoor unit fan rotation when the outdoor unit is stopped during cooling operation.

Function number	Setting value	Setting description	Factory setting
49	00	Disable	
	01	Enable	
	02	Remote controller	◆

00: When the outdoor unit is stopped, the indoor unit fan operates continuously following the setting on the remote controller.

01: When the outdoor unit is stopped, the indoor unit fan operates intermittently at a very low speed.

02: Enable or disable this function by remote controller setting.

NOTE: Set to "00" or "01" when connecting a remote controller that cannot set the Fan control for energy saving function or connecting a network converter. To confirm if the remote controller has this setting, refer to the operating manual of each remote controller.

10) Switching functions for external output terminal

Functions of the external output terminal can be switched. For details, refer to “External input and output”.

Function number	Setting value	Setting description	Factory setting
60	00	Operation status	◆
	01—08	(Setting prohibited)	
	09	Error status	
	10	Indoor unit fan operation status	
	11	External heater	

2. Function settings (For outdoor unit)

Perform appropriate function setting locally according to the installation environment.

NOTE: Incorrect settings can cause a product malfunction.

⚠ CAUTION

- Before setting up the switch buttons, discharge the static electricity from your body.
- Never touch the terminals or the patterns on the parts that are mounted on the PCB.

2-1. Control PCB and switch buttons location

Control PCB of the outdoor unit is located as shown in the following figure.

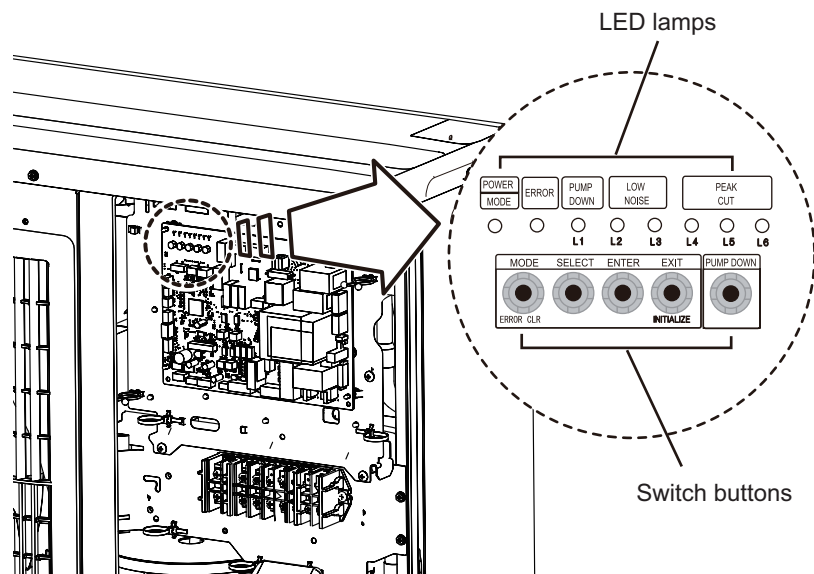

■ Switch buttons and the functions

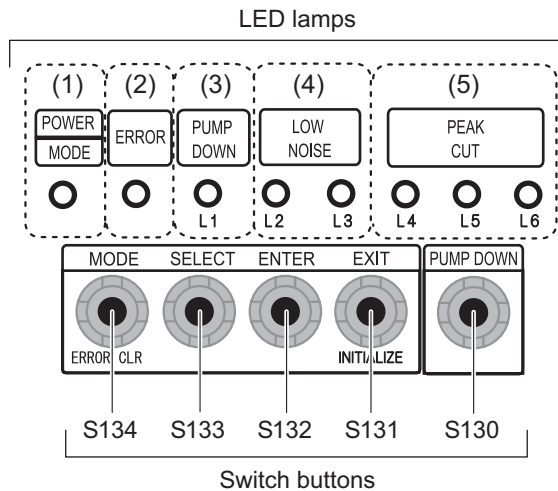

LED lamp			Function or operation method
(1)	POWER/MODE	Green	Lights on while power on. Blinks to show the local setting on the outdoor unit or the error code.
(2)	ERROR	Red	Blinks during error operation.
(3)	PUMP DOWN (L1)	Orange	Lights on during pump down operation.
(4)	LOW NOISE MODE (L2 and L3)	Orange	Lights on during "Low noise mode" when local setting is activated. (Light pattern of L2 and L3 indicates the low noise level.)
(5)	PEAK CUT MODE (L4, L5, and L6)	Orange	Lights on during "Peak cut mode" when local setting is activated. (Light pattern of L4, L5, and L6 indicates the peak cut level.)

Switch button		Function or operation method
S134	MODE	Switches between "Local setting" and "Error code display".
S133	SELECT	Switches between the individual "Local settings" and the "Error code displays".
S132	ENTER	Switches between the individual "Local settings" and the "Error code displays".
S131	EXIT	Returns to "Operation status display".
S130	PUMP DOWN	Starts the pump down operation.

FIELD WORKING

FIELD WORKING

2-2. Local setting procedure

NOTE: Before performing the function setting, be sure to stop the operation of the air conditioner.

■ Low noise mode

1. Press the MODE switch button (S134) for 3 seconds or more to switch to "Local setting mode".
2. After confirming the LED lamp of POWER/MODE blinks 9 times, press the ENTER switch button (S132).

POWER MODE	ERROR	PUMP DOWN (L1)	LOW NOISE (L2) (L3)		PEAK CUT (L4) (L5) (L6)		
Blinks (9 times)	○	○	○	○	○	○	○

Sign "○": Lights off

3. Press the SELECT switch button (S133), and adjust the LED lamp as shown below. Then the LED lamp indicates the current setting.

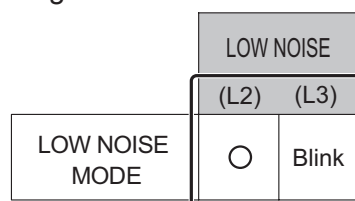

4. Press the ENTER switch button (S132).

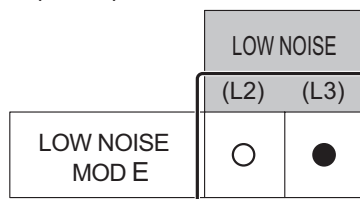

Sign "●": Lights on

5. Press the SELECT switch button (S133), and adjust the LED lamps as shown below.

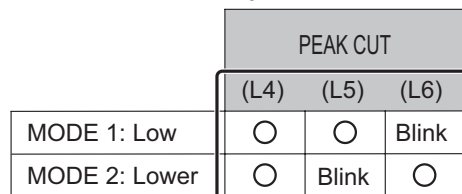

6. Press the ENTER switch button (S132) and fix it.

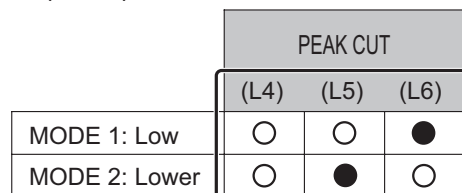

7. To return to "Operating status display (Normal operation)", press the EXIT switch button (S131).

In case of missing how many times you pressed the SELECT and ENTER switch buttons:

1. To return to "Operation status display (Normal operation)", press the EXIT switch button once.
2. Restart from the beginning of setting procedure.

■ Peak cut mode

1. Press the MODE switch button (S134) for 3 seconds or more to switch to “Local setting mode”.
2. After confirming the LED lamp of POWER/MODE blinks 9 times, press the ENTER switch button (S132).

POWER MODE	ERROR	PUMP DOWN (L1)	LOW NOISE		PEAK CUT		
			(L2)	(L3)	(L4)	(L5)	(L6)
Blinks (9 times)	○	○	○	○	○	○	○

Sign “○”: Lights off

3. Press the SELECT switch button (S133), and adjust the LED lamp as shown below. Then the LED lamp indicates the current setting.

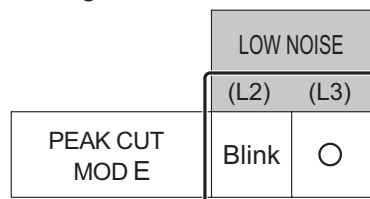

4. Press the ENTER switch button (S132).

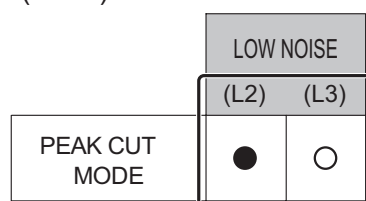

Sign “●”: Lights on

5. Press the SELECT switch button (S133), and adjust the LED lamps as shown below.

	PEAK CUT		
	(L4)	(L5)	(L6)
0 % of rated input ratio	○	○	Blink
50 % of rated input ratio	○	Blink	○
75 % of rated input ratio	○	Blink	Blink
100 % of rated input ratio	Blink	○	○

6. Press the ENTER switch button (S132) and fix it.

	PEAK CUT		
	(L4)	(L5)	(L6)
0 % of rated input ratio	○	○	●
50 % of rated input ratio	○	●	○
75 % of rated input ratio	○	●	●
100 % of rated input ratio	●	○	○

7. To return to “Operating status display (Normal operation)”, press the EXIT switch button (S131).

NOTE: When pressed number is lost during setting, you must redo the setting procedure. Return to “Operation status display (Normal operation)” by pressing the EXIT switch button once, and restart from the beginning of the setting procedure.

3. External input and output (For indoor unit)

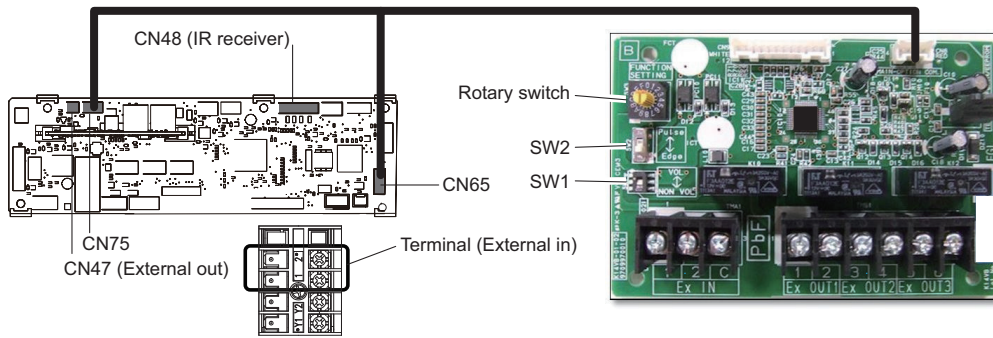

Fig. Indoor unit PCB

Fig. External input and output PCB

Connecting point		Input/Output	Function	Input select	Input signal
Indoor unit	Terminal	Input	Operation/Stop Forced stop	Dry contact	Edge
	CN47	Output	Operation status	—	—
			Error status		
			Indoor unit fan operation status		
External heater output					
External input and output PCB (UTY-XCSX)	Ex IN 1/2	Input	Operation/Stop	Dry contact/Apply voltage	Edge/Pulse
	Ex IN 1		Forced thermostat off		Edge
	Ex OUT 1 Ex OUT 2 Ex OUT 3	Output	Operation status	—	—
			Error status		
Indoor unit fan operation status					
External heater output					

NOTE: For details of the switching function, refer to "Setting of external input and output" on page 05-15.

FIELD WORKING

FIELD WORKING

3-1. External input

- "Operation/Stop" mode or "Forced stop" mode can be selected with function setting of indoor unit.
- A twisted pair cable should be used. Maximum length of cable is 150 m.
- Use an external input and output cable with appropriate external dimension, depending on the number of cables to be installed.
- The wire connection should be separate from the power cable line.

Indoor unit

Indoor unit functions such as Operation/Stop can be done by using indoor unit terminals.

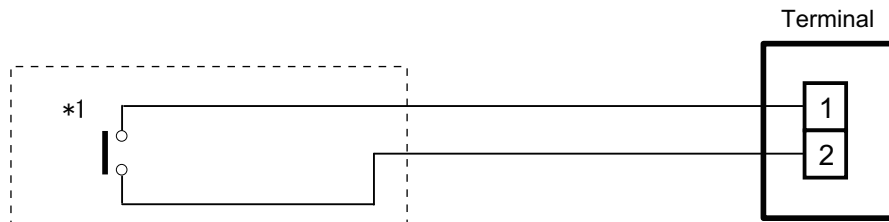

*1: The switch can be used on the following condition: DC 12 V to 24 V, 1 mA to 15 mA.

External input and output PCB

The indoor unit Operation/Stop can be set by using the input terminal on the PCB.

Input select

Use either one of these types of terminals according to the application. (Both types of terminals cannot be used simultaneously.)

– Dry contact

In case of internal power supply, set the slide switch of SW1 to "NON VOL" side.

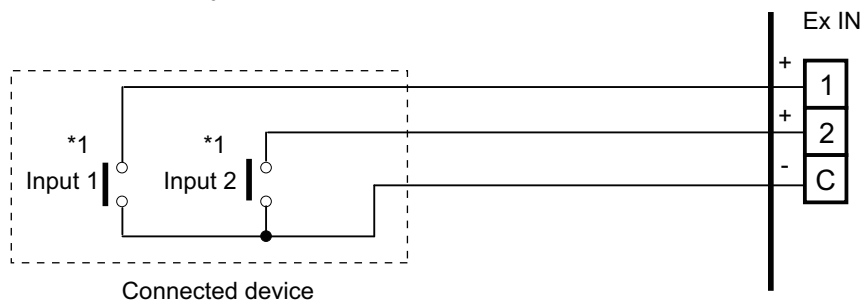

*1: The switches can be used on the following condition: DC 12 V to 24 V, 1 mA to 15 mA.

– Apply voltage

In case of external power supply, set the slide switch of SW1 to "VOL" side.

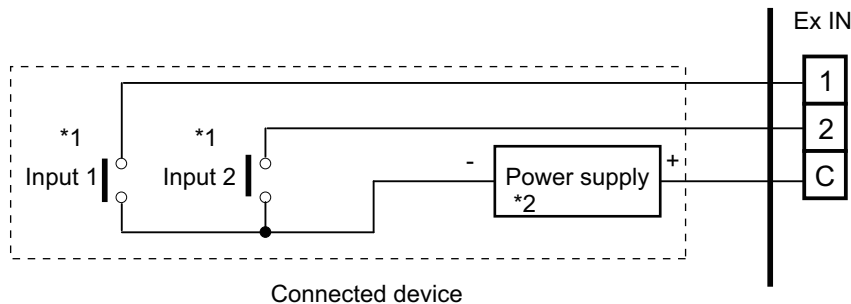

*1: The switches can be used on the following condition: DC 12 V to 24 V, 1 mA to 15 mA.

*2: Make the power supply DC 12 V to 24 V, 10 mA or more.

■ Input signal type

- **Indoor unit**

Input signal type is only "Edge".

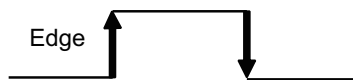

- **External input and output PCB**

The input signal type can be selected.

Signal type (edge or pulse) can be switched by the DIP switch 2 (SW2) on the External input and output PCB.

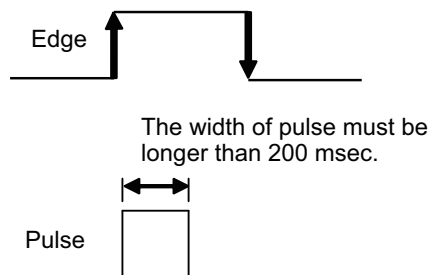

NOTE: The input signal supports the following switch type:

- Edge: Alternate type switch
- Pulse: Momentary type switch

3-2. External output

Use an external output cable with appropriate external dimension, depending on the number of cables to be installed.

Indoor unit

- A twisted pair cable (22 AWG) should be used. Maximum length of cable is 25 m.
- Output voltage: High DC 12 V \pm 2 V, Low 0 V.
- Permissible current: 50 mA
- For details, refer to "[Setting of external input and output](#)" on page 05-15.

When indicator, etc. are connected directly

Example: Function setting number 60 is set to "00"

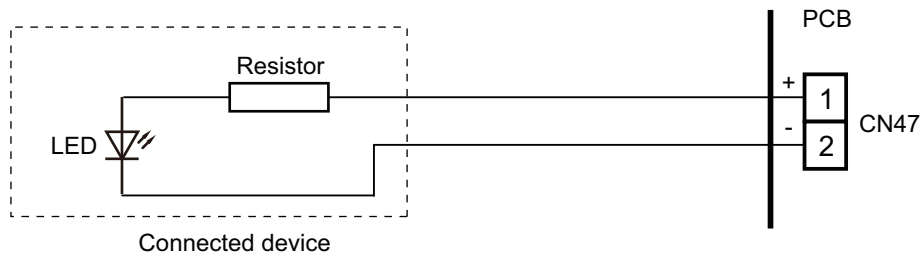

When connecting with a device equipped with a power supply

Example: Function setting number 60 is set to "00"

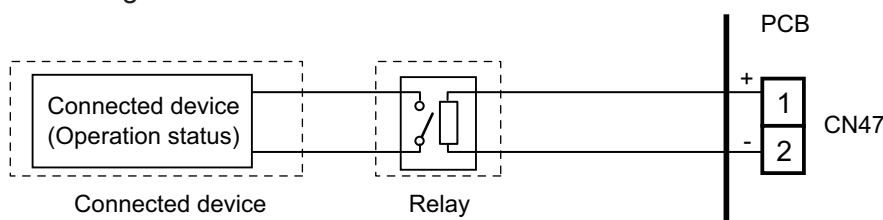

External input and output PCB

- A twisted pair cable (22 AWG) should be used.
- Permissible voltage and current: DC 5 V to 30 V/3 A, AC 30 V to 250 V/3 A
- For details, refer to "[Setting of external input and output](#)" on page 05-15.

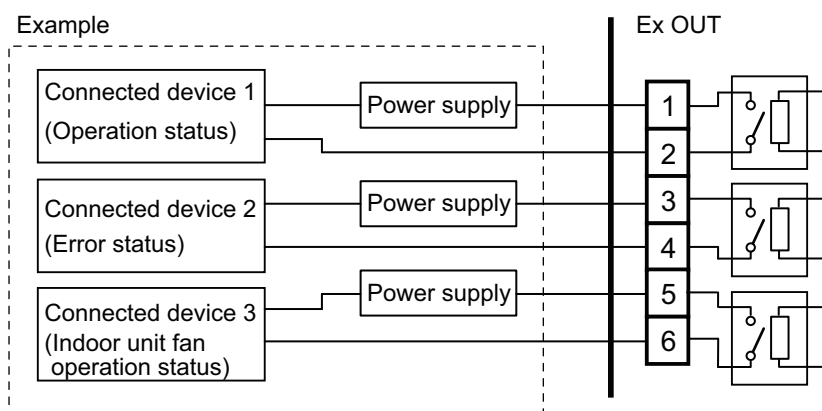

3-3. Setting of external input and output

- Indoor unit

Input		
Connection point	Function setting number 46	Function
Terminal	00	Operation/Stop mode 1
	01	(Setting prohibited)
	02	Forced stop mode
	03	Operation/Stop mode 2

Output		
Connection point	Function setting number 60	Function
CN47	00	Operation status
	01 to 08	(Setting prohibited)
	09	Error status
	10	Indoor unit fan status
	11	External heater output

- External input and output PCB

Switch setting		Input		Output		
Rotary switch	SW2	Ex IN 1	Ex IN 2	Ex OUT 1	Ex OUT 2	Ex OUT 3
1	Edge	Operation/Stop	Not available	Operation status	Error status	Indoor unit fan status
	Pulse	Operation	Stop			
2	Edge*	Forced thermostat off	Not available	Error status	Indoor unit fan operation status	External heater output
3 to 9, A		(Setting prohibited)				
B		Forced thermostat off	Not available	Operation status	Indoor unit fan operation status	External heater output
C		Forced thermostat off	Not available	Operation status	Error status	External heater output
D		Forced thermostat off	Not available	Operation status	Indoor unit fan operation status	Error status

NOTES:

- When the rotary switch is selected to "1", the operation of the terminal block input of the indoor unit and the External input and output PCB input are the same. The operation content depends on the setting of function setting number 46.
- *: The external input other than "Operation/Stop" is available only when the SW2 is set to "Edge".

3-4. Details of control input function

■ Operation/Stop mode 1

- In the case of "Edge" input

Function setting	External input and output PCB		External input		Input signal	Command
	Rotary switch	SW2				
46-00	—		Input of indoor unit	Terminal	Off → On	Operation
	—				On → Off	Stop
	1	Edge	External input and output PCB	Ex IN 1	Off → On	Operation
					On → Off	Stop

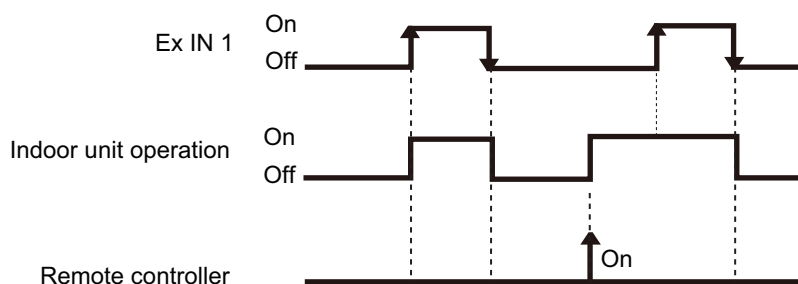

- In the case of "Pulse" input

Function setting	External input and output PCB		External input		Input signal	Command
	Rotary switch	SW2				
46-00	1	Pulse	External input and output PCB	Ex IN 1	Pulse	Operation
				Ex IN 2		Stop

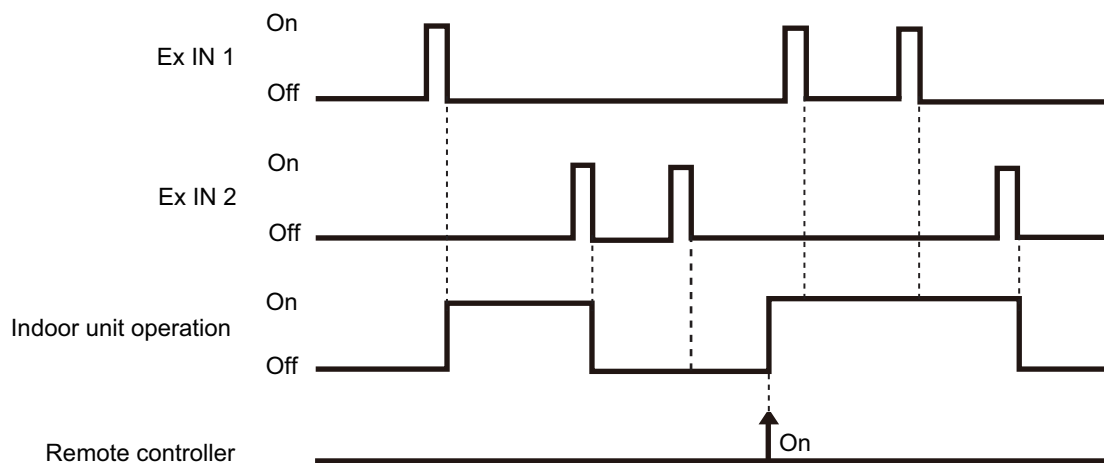

NOTES:

- The last command has priority.
- The indoor units within the same remote controller group operates in the same mode.

FIELD WORKING

FIELD WORKING

■ Forced stop

- In the case of "Edge" input

Function setting	External input and output PCB		External input		Input signal	Command
	Rotary switch	SW2				
46-02	—		Input of indoor unit	Terminal	Off → On	Forced stop (R.C. disabled)
					On → Off	Normal (R.C. enabled)
	1	Edge	External input and output PCB	Ex IN 1	Off → On	Forced stop (R.C. disabled)
					On → Off	Normal (R.C. enabled)

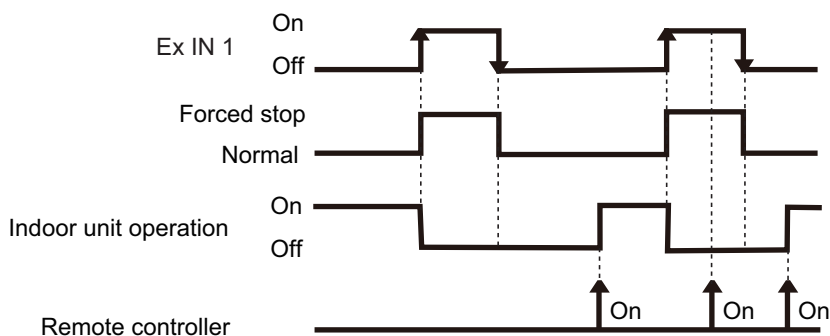

- In the case of "Pulse" input

Function setting	External input and output PCB		External input		Input signal	Command
	Rotary switch	SW2				
46-02	1	Pulse	External input and output PCB	Ex IN 1	Pulse	Forced stop (R.C. disabled)
				Ex IN 2		Normal (R.C. enabled)

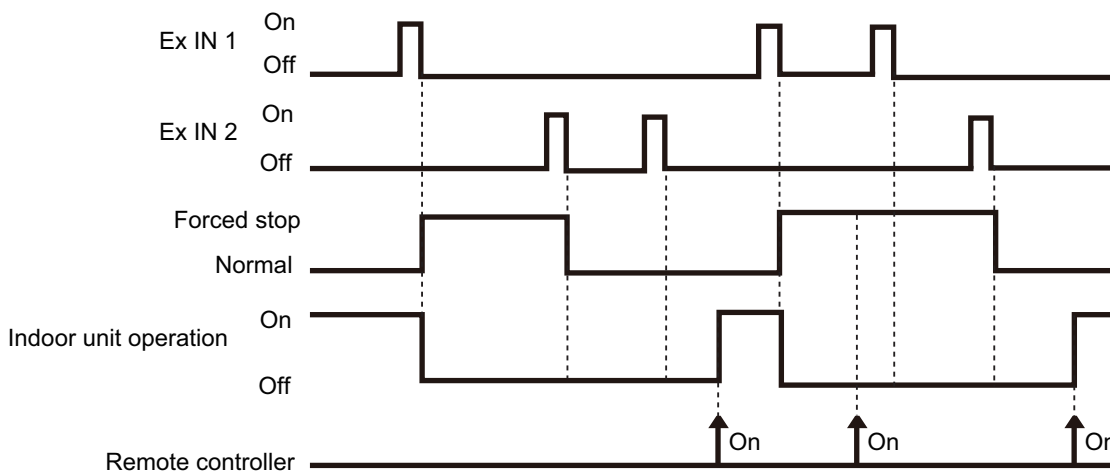

NOTES:

- When the forced stop is triggered, indoor unit stops and Operation/Stop operation by the remote controller is restricted.
- When forced stop function is used with forming a remote controller group, connect the same equipment to each indoor unit within the group.

■ Operation/Stop mode 2

- In the case of "Edge" input

Function setting	External input and output PCB		External input		Input signal	Command
	Rotary switch	SW2				
46-03	—		Input of indoor unit	Terminal	Off → On	Operation (R.C. enabled)
					On → Off	Stop (R.C. disabled)
	1	Edge	External input and output PCB	Ex IN 1	Off → On	Operation (R.C. enabled)
					On → Off	Stop (R.C. disabled)

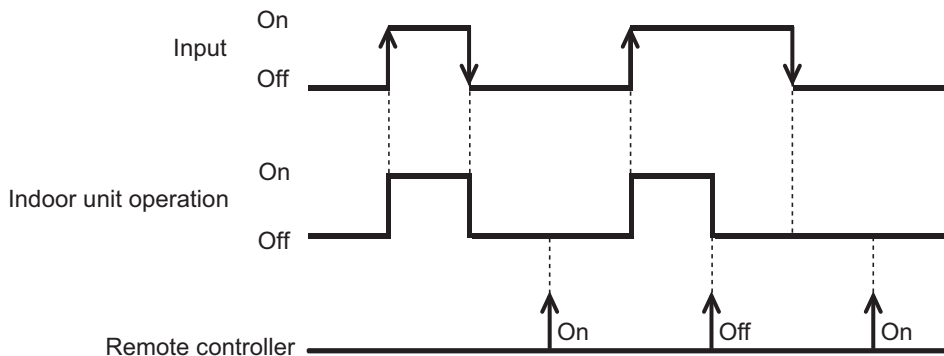

- In the case of "Pulse" input

Function setting	External input and output PCB		External input		Input signal	Command
	Rotary switch	SW2				
46-03	1	Pulse	External input and output PCB	Ex IN 1	Pulse	Operation (R.C. enabled)
				Ex IN 2		Stop (R.C. disabled)

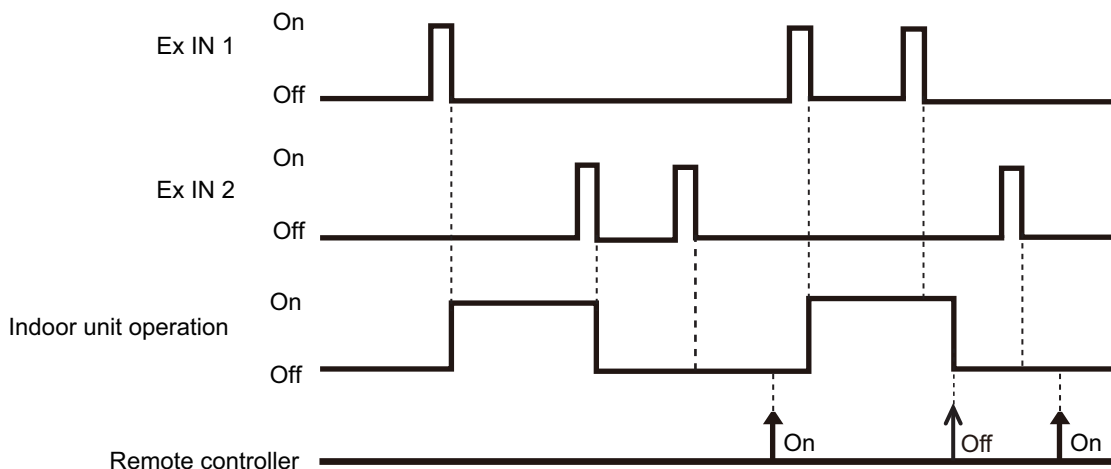

NOTE: When "Operation/Stop" mode 2 function is used with forming a remote controller group, connect the same equipment to each indoor unit within the group.

■ Forced thermostat off

External input and output PCB	External input		Input signal	Command
Rotary switch				
2, B, C, D	External input and output PCB	Ex IN 1	Off → On	Thermostat off
			On → Off	Normal operation

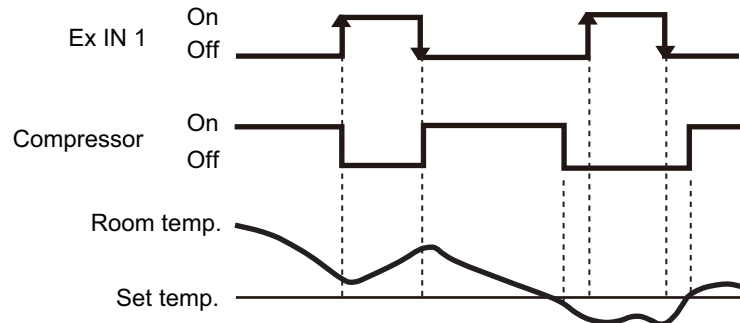

FIELD WORKING

FIELD WORKING

3-5. Details of control output function

■ Operation status

Function setting	External input and output PCB	External output		Output signal	Status
	Rotary switch				
60-00	—	Output of indoor unit	CN47	Off → On	Operation
				On → Off	Stop
—	1, B, C, D	External input and output PCB	Ex OUT 1	Off → On	Operation
				On → Off	Stop

The output is low when the unit is stopped.

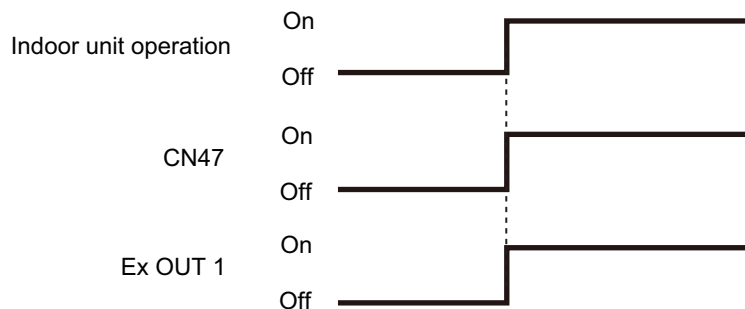

■ Error status

Function setting	External input and output PCB	External output		Output signal	Status
	Rotary switch				
60-09	—	Output of indoor unit	CN47	Off → On	Error
				On → Off	Normal
—	2	External input and output PCB	Ex OUT 1	Off → On	Error
				On → Off	Normal
—	1, C	External input and output PCB	Ex OUT 2	Off → On	Error
				On → Off	Normal
—	D	External input and output PCB	Ex OUT 3	Off → On	Error
				On → Off	Normal

The output is on when an error is generated for the indoor unit.

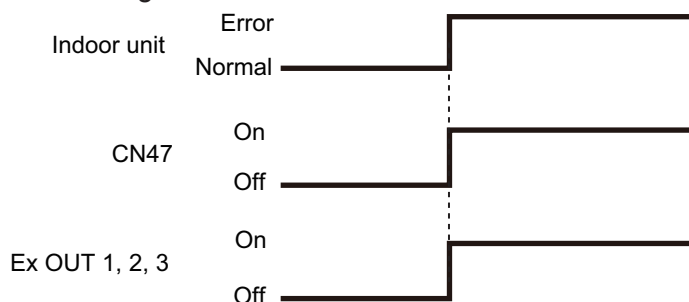

■ Indoor unit fan operation status

Function setting	External input and output PCB	External output		Output signal	Status
	Rotary switch				
60-10	—	Output of indoor unit	CN47	Off → On	Fan run
				On → Off	Fan stop
—	2, B, D	External input and output PCB	Ex OUT 2	Off → On	Fan run
				On → Off	Fan stop
—	1	External input and output PCB	Ex OUT 3	Off → On	Fan run
				On → Off	Fan stop

Output signal	Condition
On	The indoor unit fan is operating.
Off	The fan is stopped or during cold air prevention. During thermostat off when in dry mode operation.

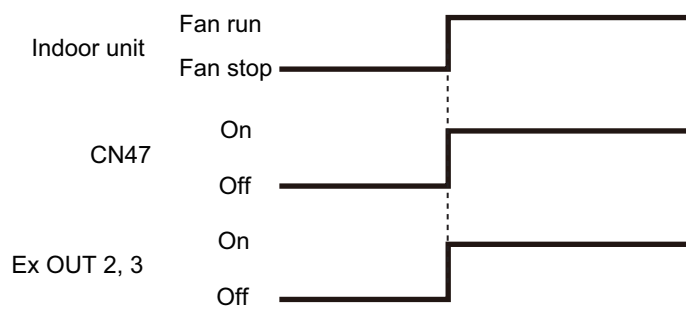

External heater output

Function setting	External input and output PCB	External output		Output signal	Control
	Rotary switch				
60-11	—	Output of indoor unit	CN47	Off → On	Heater on
				On → Off	Heater off
—	2, B, C	External input and output PCB	Ex OUT 3	Off → On	Heater on
				On → Off	Heater off

Output signal	Condition
Off → On	Heater turns on as shown in diagram of heating temperature
On → Off	Heater turns off as shown in diagram of heating temperature <ul style="list-style-type: none"> • Other than Heating mode • Error occurred • Forced thermo off • Fan stop protection

Specifications of the signal output performance are as shown as follows:

Example: When set temperature (T_s) is set at 22°C;

- And room temperature (T_r) increase above 12°C, signal output is on.
- And T_r increase above 21°C, signal output is off.
- And T_r decrease below 19°C, signal output is on.
- And T_r decrease below 10°C, signal output is off.

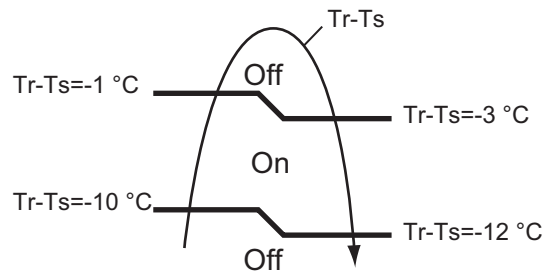

The output also turns off in defrost operation.

4. External input and output (For outdoor unit)

With using external input and output functions, this product can be operated inter-connectedly with an external device.

Connector	Input	Output	Remarks
P580	Low noise mode	—	See external input/output settings for details.
PA580	Peak cut mode	—	
P590	—	Error status	
PA590	—	Compressor status	

4-1. External input

With using external input function, on/off status of “Low noise mode” and “Peak cut mode” can be specified by the external signal.

■ Low noise mode

In following condition, the operating noise of the outdoor unit reduces comparing from the one in normal operating condition:

The air conditioner is set to the “Low noise mode” when closing the contact input of a commercial timer or on/off switch to a connector on the control PCB of the outdoor unit.

NOTE: Product performance may drop depending on some conditions such as the outdoor temperature.

• Circuit diagram example

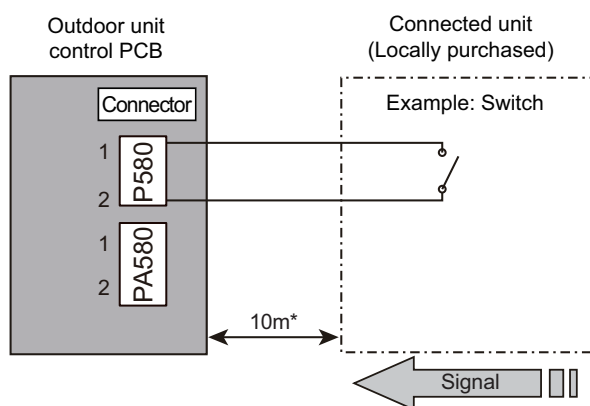

- Contact capacity: DC 24 V or more, 10 mA or more.
- *: Make the distance from the PCB to the connected unit within 10 m.
- Construct a circuit as shown in this figure with using optional parts mentioned below.
- Input signal: On in “Low noise mode”
- Input signal: Off in normal operation
- To set the level of “Low noise mode”, refer to “Low noise mode” in ["Local setting procedure"](#) on page 05-9.

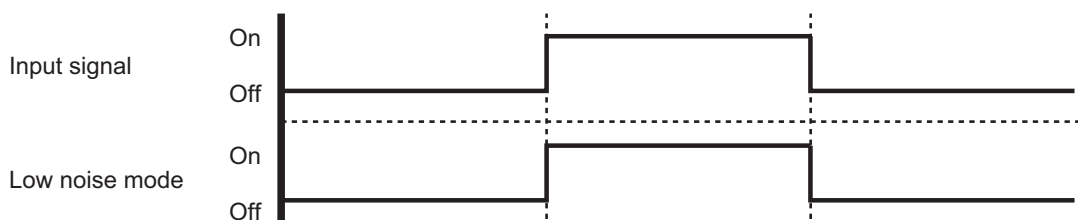

• Optional part

Part name	Model name	Exterior
External Connect Kit	UTY-XWZXZ3	External input wire

■ Peak cut mode

By performing following on-site work, operation that suppresses the current value can be enabled: The air conditioner is set to the “Peak cut mode” when closing the contact input of a commercial timer or on/off switch to a connector on the control PCB of the outdoor unit.

• Circuit diagram example

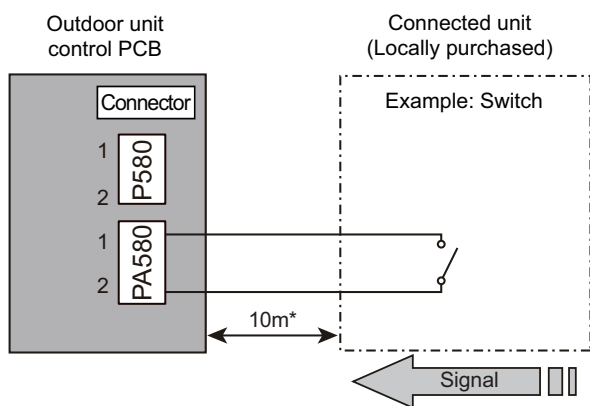

- Contact capacity: DC 24 V or more, 10 mA or more.
- *: Make the distance from the PCB to the connected unit within 10 m.
- Construct a circuit as shown in this figure with using optional parts mentioned below.
- Input signal: On in “Peak cut mode”
- Input signal: Off in normal operation
- To set the level of “Peak cut mode”, refer to “Peak cut mode” in ["Local setting procedure"](#) on page 05-9.

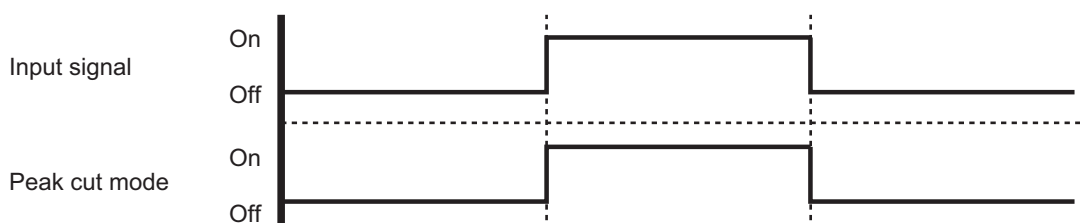

• Optional part

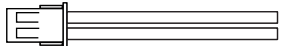
Part name	Model name	Exterior
External Connect Kit	UTY-XWZXZ3	External input wire 

4-2. External output

With using external output function, some status signals are transmitted to the control PCB, and the related LED lamp indicates the status of this product.

■ Error status output

Signal on air conditioner error status is generated when a malfunction occurs.

• Circuit diagram example

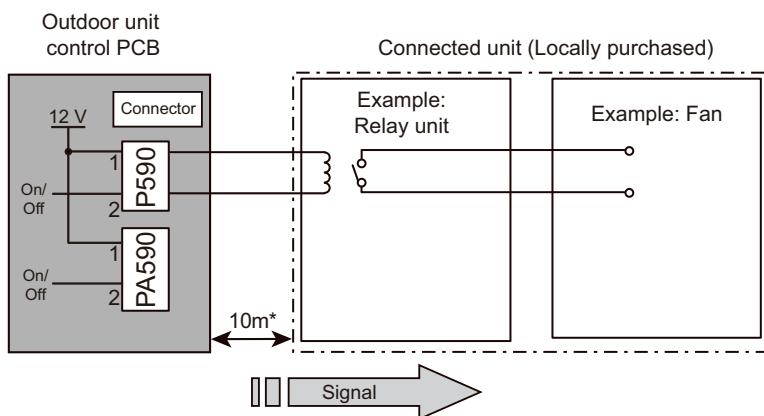

- Output voltage (Vcc): DC 12 V 50 mA or less
- *: Make the distance from the PCB to the connected unit within 10 m.

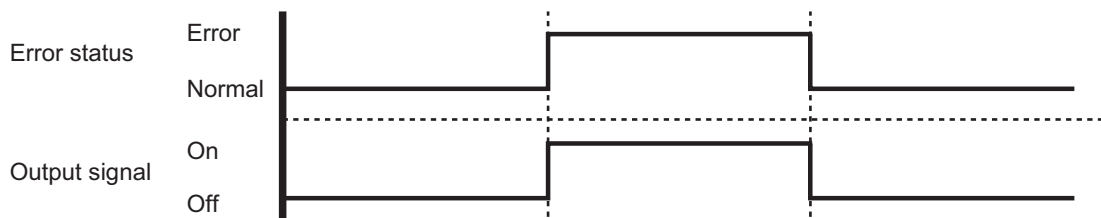

• Optional part

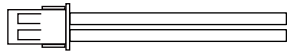
Part name	Model name	Exterior
External Connect Kit	UTY-XWZXZ3	External output wire 

FIELD WORKING

FIELD WORKING

■ Compressor status output

Signal on compressor operation status is generated when the compressor is running.

• Circuit diagram example

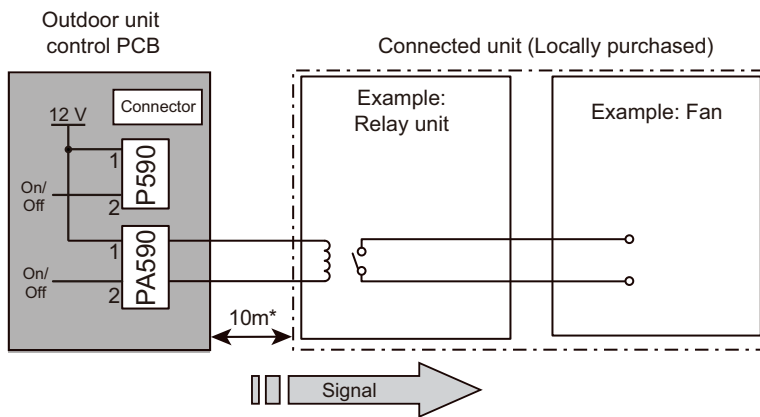

- Output voltage (Vcc): DC 12 V 50 mA or less
- *: Make the distance from the PCB to the connected unit within 10 m.

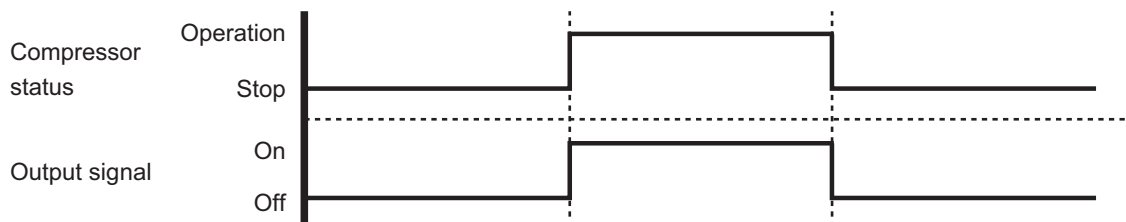

• Optional part

Part name	Model name	Exterior
External Connect Kit	UTY-XWZXZ3	External output wire 

FIELD WORKING

FIELD WORKING