

# ROEN EST S.p.A.

34077 Ronchi dei Legionari (GO) - Italy

Tel.: +39 0481 474140 - Fax: +39 0481 779997

http: www.roenest.com - e-mail: info@roenest.com

**ROENEST**  
GROUP  
HEAT EXCHANGERS AND MORE

Client:

Attention of:

Your rif.:

Our rif.:

FC.N.45.3.08-4T-D

Operator:

REVENT 1.2.94

Date: 09.01.2021 15.57

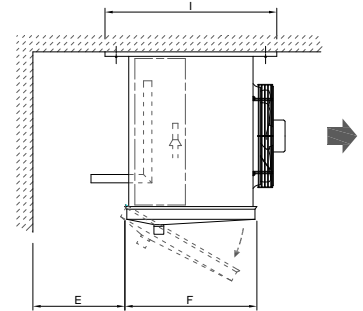
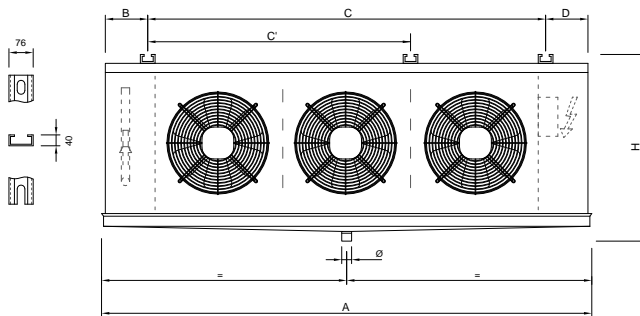

Capacity (kW)

19,45

Electric Defrost (kW)

10,8

## AIR

Flow (m<sup>3</sup>/h)

14700

Temp.IN (°C)

0

Air Throw (m)

25

## FLUID

R449a

Temp.Evap. (dew) (°C)

-8

## FANS

Nr.

3

Diameter (mm)

450

RPM (min<sup>-1</sup>)

1400

Supply line (V/P/Hz)

400/3/50

Current (A)

3x0,9

Capacity (W)

3x590

## NOISE

Pressure level (dB(A))

55

Distance (m)

5

## EXCHANGER

### FINS

Fins material

AL

Fin pitch (mm)

Surface (m<sup>2</sup>)

116

### TUBES

Material

CU

Volume (dm<sup>3</sup>)

18

### HEADERS

Material

CU

IN (mm)

22

OUT (mm)

35

### DIMENSIONS

Length(A) (mm)

2525

Width(F) (mm)

550

Height(H) (mm)

740

Fixing brackets(C) (mm)

2205

Weight (kg)

128

Frost Factor Correction 6/24h

**Ventilator data are approximated**

**Attention!! Thanks to the continuous evolution of the products that Roen Est develops, the measures and technical solutions reported here may not correspond to the latest versions. Please, contact the Roen Est Technical Office to have the appropriate confirmations.**