

AIR CONDITIONER

**Wall mounted type**

# SERVICE MANUAL

---

---

INDOOR



ASYG30KMTA  
ASYG36KMTA

---

OUTDOOR



AOYG30KMTA  
AOYG36KMTA

---

**Notices:**

- Product specifications and design are subject to change without notice for future improvement.
- For further details, please check with our authorized dealer.

**Trademarks**

The following term and logo are trademarks of Fujitsu General Limited in the United States, other countries or both:

FGLair™



Android and Google Play are trademarks of Google Inc.

App Store is a service mark of Apple Inc., registered in the U.S. and other countries.

IOS is a trademark or registered trademark of Cisco in the U.S. and other countries and is used under license.

# CONTENTS

**1. GENERAL INFORMATION**

**2. TECHNICAL DATA AND PARTS LIST**

**3. TROUBLESHOOTING**

**4. CONTROL AND FUNCTIONS**

**5. FIELD WORKING**



# 1. GENERAL INFORMATION

# CONTENTS

## 1. GENERAL INFORMATION

<b>1. Specifications</b> .....	<b>01-1</b>
1-1. Indoor units.....	01-1
1-2. Outdoor units.....	01-3
<b>2. Dimensions</b> .....	<b>01-4</b>
2-1. Indoor unit .....	01-4
2-2. Outdoor unit.....	01-6

# 1. Specifications

## 1-1. Indoor units

Type				Wall mounted				
				Inverter heat pump				
Model name				ASYG30KMTA	ASYG36KMTA			
Power supply				230 V ~ 50 Hz				
Power supply intake				Outdoor unit				
Available voltage range				198—264 V				
Capacity	Cooling	Rated	kW	8.0	9.4			
			Btu/h	27,300	32,100			
		Min.—Max.	kW	2.9—9.0	2.9—10.0			
	Heating	Rated	Btu/h	9,900—30,700	9,900—34,100			
			kW	8.8	10.1			
		Min.—Max.	kW	2.2—11.0	2.7—11.2			
Input power	Cooling	Rated	kW	2.33	3.16			
			Min.—Max.	0.54—3.86	0.54—4.30			
		Heating	Rated	kW	2.20	2.73		
	Min.—Max.			0.48—4.23	0.48—4.30			
	Fan		HIGH	W		62.0		
		MED			36.5			
LOW		21.0						
QUIET		11.5						
Current	Cooling	Rated	A	10.2	13.9			
	Heating		9.7	12.0				
EER	Cooling		kW/kW	3.43	2.97			
COP	Heating		kW/kW	4.00	3.70			
Sensible capacity	Cooling		kW	6.15	6.70			
Power factor	Cooling		%	99				
	Heating		%	99				
Moisture removal			L/h (pints/h)	2.6 (4.6)	3.8 (6.7)			
Maximum operating current*1	Cooling		A	21.0	21.5			
	Heating		A	21.0	21.5			
Fan	Cooling	HIGH	m <sup>3</sup> /h		1,330			
				MED	1,100			
				LOW	920			
				QUIET	720			
				Heating	HIGH	1,330		
	Heating	MED		1,100				
			LOW	920				
			QUIET	720				
			Type × Q'ty	Sirocco fan × 1				
			Motor output	W	61			
Sound pressure level*2	Cooling	HIGH	dB (A)		50			
				MED	44			
				LOW	40			
				QUIET	33			
	Heating	HIGH		49				
			MED	44				
			LOW	39				
			QUIET	33				
			Heat exchanger	Dimensions (H × W × D)		mm	Main: 448 × 900 × 30 Sub1: 84 × 900 × 13.3 Sub2: 126 × 900 × 13.3	
				Fin pitch			Main: 1.2, Sub: 1.4	
Rows × Stages		Main: 3 × 28, Sub1: 1 × 4, Sub2: 1 × 6						
Pipe type		Copper tube						
Fin type		Aluminum						
Enclosure	Material		Polystyrene					
	Color		White Approximate color of Munsell N 9.25/					
Dimensions (H × W × D)	Net	mm	340 × 1,150 × 280					
	Gross		405 × 1,270 × 450					
Weight	Net	kg	18.5					
	Gross		24.5					
Connection pipe	Size	Liquid	mm (in)	Ø 9.52 (Ø 3/8)				
		Gas		Ø 15.88 (Ø 5/8)				
	Method		Flare					
Drain hose	Material		PVC					
	Size		mm					
Operation range	Cooling		°C	18 to 32				
			%RH	80 or less				
	Heating		°C	16 to 30				
Remote controller					Wireless or Mobile app (FGLair*3) (Wired [option])			

Type	Wall mounted	
	Inverter heat pump	
Model name	ASYG30KMTA	ASYG36KMTA
<b>NOTES:</b> <ul style="list-style-type: none"> <li>Specifications are based on the following conditions:                             <ul style="list-style-type: none"> <li>Cooling: Indoor temperature of 27 °CDB/19 °CWB, and outdoor temperature of 35 °CDB/24 °CWB.</li> <li>Heating: Indoor temperature of 20 °CDB/15 °CWB, and outdoor temperature of 7 °CDB/6 °CWB.</li> <li>Pipe length: 5.0 m, Height difference: 0 m. (Between outdoor unit and indoor unit.)</li> </ul> </li> <li>Protective function might work when using it outside the operation range.</li> <li>*1: Maximum operating current is the total current of the indoor unit and the outdoor unit.</li> <li>*2: Sound pressure level:                             <ul style="list-style-type: none"> <li>Measured values in manufacturer's anechoic chamber.</li> <li>Because of the surrounding sound environment, the sound levels measured in actual installation conditions might be higher than the specified values here.</li> </ul> </li> <li>*3: Available on Google Play store or on App Store. For details, refer to the setting manual.</li> <li>This data is based on EN 14511 standard.</li> </ul>		

Specifications for ErP Lot 10					
Model name		ASYG30KMTA		ASYG36KMTA	
Energy efficiency class	Cooling	A++		A++	
	Heating (Average)	A+		A+	
Pdesign	Cooling	kW	8.00	9.40	
	Heating (Average)		6.50	7.10	
SEER	Cooling	kWh/kWh	6.67	6.14	
SCOP	Heating (Average)		4.54	4.52	
Annual energy consumption	QCE	kWh/a	419	535	
	QHE (Average)		2,001	2,198	
Sound power level	Cooling	HIGH	dB (A)	65	65
	Heating			65	65



# 1-2. Outdoor units

Type				Inverter heat pump	
Model name				AOYG30KMTA	AOYG36KMTA
Power supply				230 V ~ 50 Hz	
Power supply intake				Outdoor unit	
Available voltage range				198–264 V	
Starting current				10.2	13.9
Fan	Airflow rate	Cooling	m <sup>3</sup> /h	3,750	
		Heating		3,750	
	Type × Q'ty		Propeller × 1		
Motor output			W	100	
Sound pressure level*1	Cooling		dB (A)	53	55
	Heating			55	55
Sound power level	Cooling		dB (A)	68	70
	Heating			69	70
Heat exchanger type	Dimensions (H × W × D)		mm	Main1: 756 × 905 × 18.19	
	Fin pitch			Main2: 756 × 905 × 18.19	
	Rows × Stages		1.45		
	Pipe type		1 × 36		
	Fin		Type (Material)	Copper	
			Surface treatment	Aluminum Blue fin	
Compressor	Type × Q'ty		DC Twin rotary × 1		
	Motor output		W	1,500	
Refrigerant	Type (Global warming potential)		R32 (675)		
	Factory charge		g	1,900	
Refrigerant oil	Type		FW68D		
	Amount		cm <sup>3</sup>	600	
Enclosure	Material		Steel sheet		
	Color		Beige Approximate color of Munsell 10YR 7.5/1.0		
Dimensions (H × W × D)	Net		mm	788 × 940 × 320	
	Gross			966 × 1,027 × 445	
Weight	Net		kg	52	
	Gross			60	
Connection pipe	Size	Liquid	mm (in)	Ø9.52 (3/8)	
		Gas		Ø15.88 (5/8)	
	Method		Flare		
	Pre-charge length		m	30	
	Max. length			50	
	Max. height difference			30	
Operation range	Cooling		°C	-15 to 46	
	Heating			-15 to 24	
Drain hose	Material		LDPE		
	Size		mm	Ø13.0 (I. D.), Ø16.0 to Ø16.7 (O. D.)	

**NOTES:**

- Specifications are based on the following conditions:
  - Cooling: Indoor temperature of 27 °CDB/19 °CWB, and outdoor temperature of 35 °CDB/24 °CWB.
  - Heating: Indoor temperature of 20 °CDB/15 °CWB, and outdoor temperature of 7 °CDB/6 °CWB.
  - Pipe length: 5.0 m, Height difference: 0 m. (Between outdoor unit and indoor unit.)
- Protective function might work when using it outside the operation range.
- \*1: Sound pressure level
  - Measured values in manufacturer's anechoic chamber.
  - Because of the surrounding sound environment, the sound levels measured in actual installation conditions might be higher than the specified values here.
- This data is based on EN 14511 standard.

## 2. Dimensions

### 2-1. Indoor unit

#### ■ Models: ASYG30KMTA and ASYG36KMTA

Unit: mm

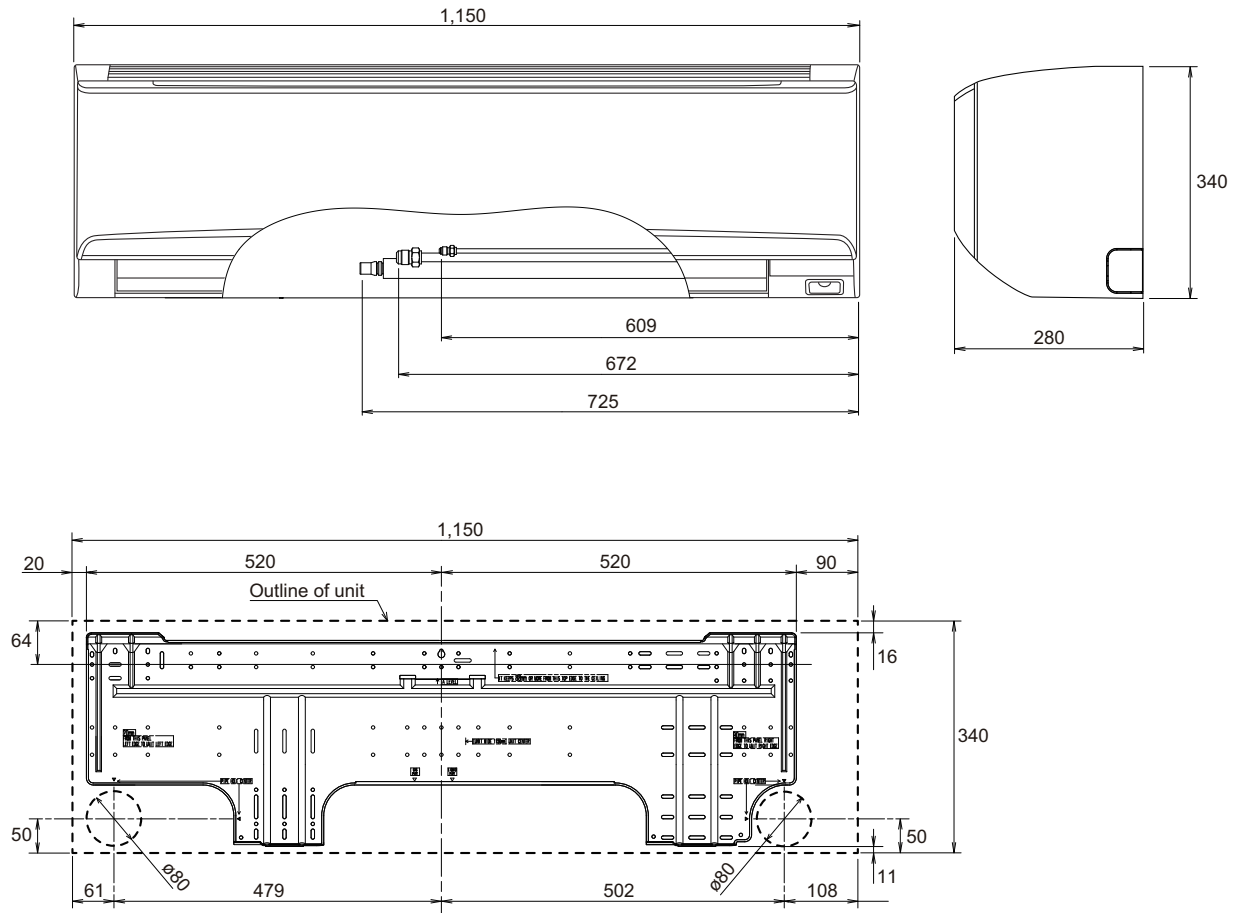

## ● Installation space requirement

Provide sufficient installation space for product safety.

Unit: mm

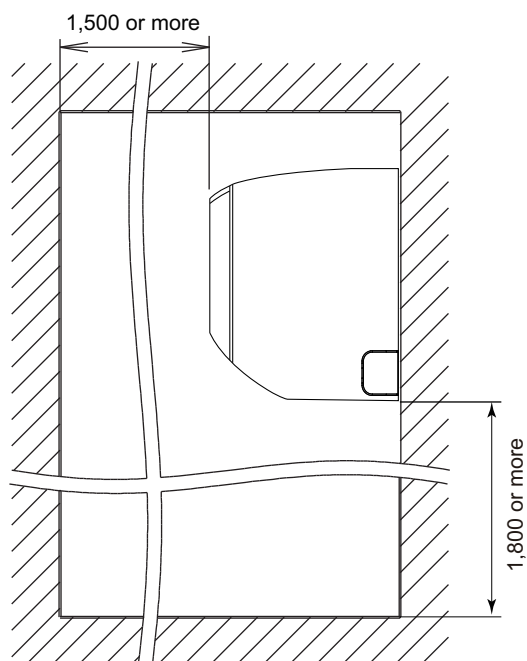
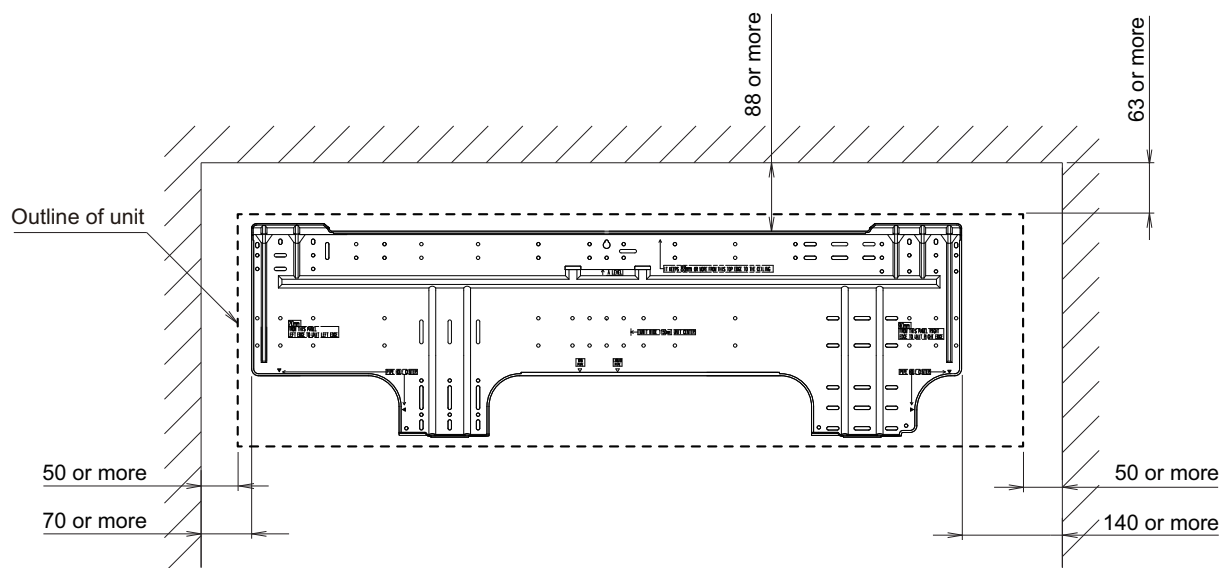

## 2-2. Outdoor unit

### ■ Models: AOYG30KMTA and AOYG36KMTA

Unit: mm

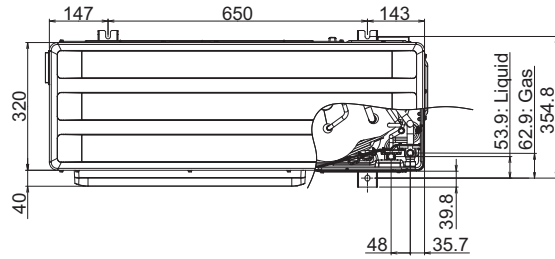

Top view

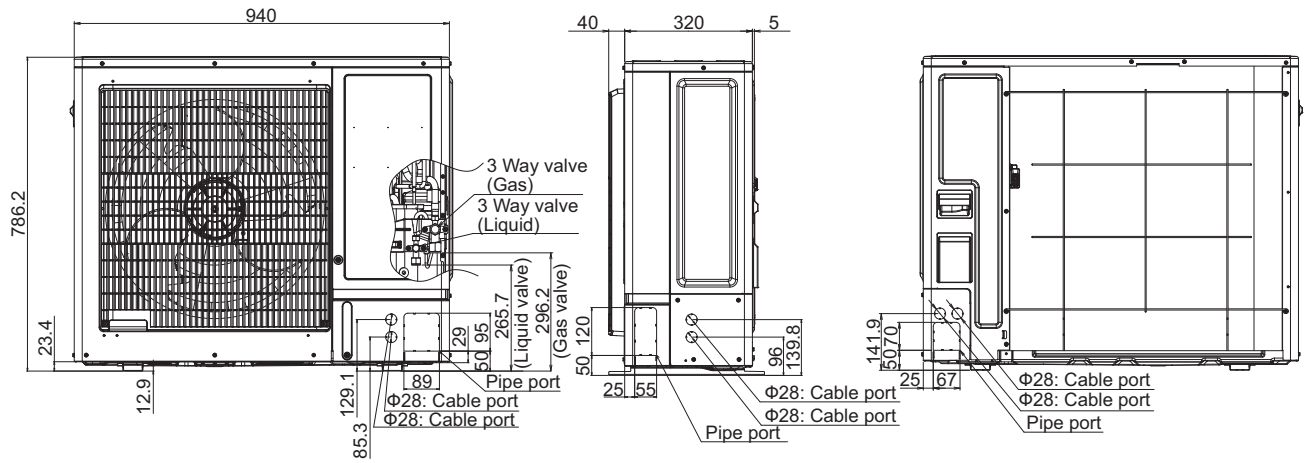

Front view

Side view

Rear view

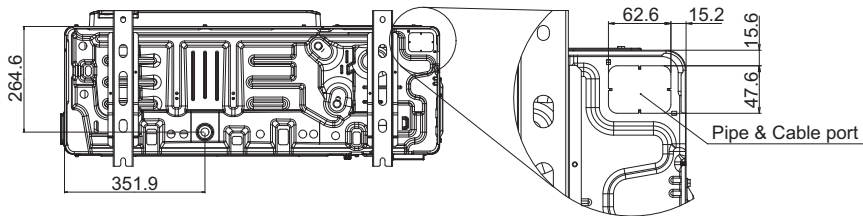

Bottom view

## **2. TECHNICAL DATA AND PARTS LIST**

# CONTENTS

## 2. TECHNICAL DATA AND PARTS LIST

<b>1. Precautions</b> .....	<b>02-1</b>
<b>2. Indoor unit parts list</b> .....	<b>02-2</b>
2-1. Models: ASYG30KMTA and ASYG36KMTA .....	02-2
<b>3. Outdoor unit parts list</b> .....	<b>02-6</b>
3-1. Models: AOYG30KMTA and AOYG36KMTA .....	02-6
<b>4. Accessories</b> .....	<b>02-10</b>
4-1. Indoor unit .....	02-10
4-2. Outdoor unit.....	02-10
<b>5. Optional parts</b> .....	<b>02-11</b>
5-1. Indoor unit .....	02-11
<b>6. Refrigerant system diagrams</b> .....	<b>02-13</b>
6-1. Models: AOYG30KMTA and AOYG36KMTA .....	02-13
<b>7. Wiring diagrams</b> .....	<b>02-14</b>
7-1. Indoor unit .....	02-14
7-2. Outdoor unit.....	02-15
<b>8. PC board diagrams</b> .....	<b>02-16</b>
8-1. Models: ASYG30KMTA and ASYG36KMTA .....	02-16
8-2. Models: AOYG30KMTA and AOYG36KMTA .....	02-17

# 1. Precautions

When you start servicing, pay attention to the following points. For detailed precautions, refer to the installation manual of the products.

## **⚠ CAUTION**

- Service personnel
    - Any person who is involved with working on or breaking into a refrigerant circuit should hold a current valid certificate from an industry-accredited assessment authority, which authorizes their competence to handle refrigerants safely in accordance with an industry recognized assessment specification.
    - Servicing shall only be performed as recommended by the equipment manufacturer. Maintenance and repair requiring the assistance of other skilled personnel shall be carried out under the supervision of the person competent in the use of flammable refrigerants.
    - Servicing shall be performed only as recommended by the manufacturer.
  - Work
    - Prior to beginning work on systems containing flammable refrigerants, safety checks are necessary to ensure that the risk of ignition is minimized. When repairing the refrigerant system, refer to the precautions written in the installation manual of the products before you start servicing.
    - Work shall be undertaken under a controlled procedure so as to minimize the risk of a flammable gas or vapor being present while the work is being performed.
    - All maintenance staff and others working in the local area shall be instructed on the nature of work being carried out.
    - Work in confined spaces shall be avoided.
    - The area around the workspace shall be sectioned off.
    - Ensure that the conditions within the area have been made safe by control of flammable material.
    - Electric shock may occur. After turning off the power, always wait 5 minutes before touching electrical components.
    - Do not touch the fins of the heat exchanger. Touching the heat exchanger fins could result in damage to the fins or personal injury such as skin rupture.
    - Do not place any other electrical products or household belongings under the product.
    - Condensation dripping from the product might get them wet, and may cause damage or malfunction to the property.
  - Checking for presence of refrigerant
    - The area shall be checked with an appropriate refrigerant detector prior to and during work, to ensure the technician is aware of potentially flammable atmospheres.
    - Ensure that the leak detection equipment being used is suitable for use with flammable refrigerants, i.e. non-sparking, adequately sealed or intrinsically safe.
- 
- Service parts information and design are subject to change without notice for product improvement.
  - For the latest information of the service parts, refer to our Service Portal.  
<https://fujitsu-general.force.com/portal/>
  - Precise figure of the service parts listed in this manual may differ from the actual service parts.

## 2. Indoor unit parts list

### 2-1. Models: ASYG30KMTA and ASYG36KMTA

#### ■ Exterior parts

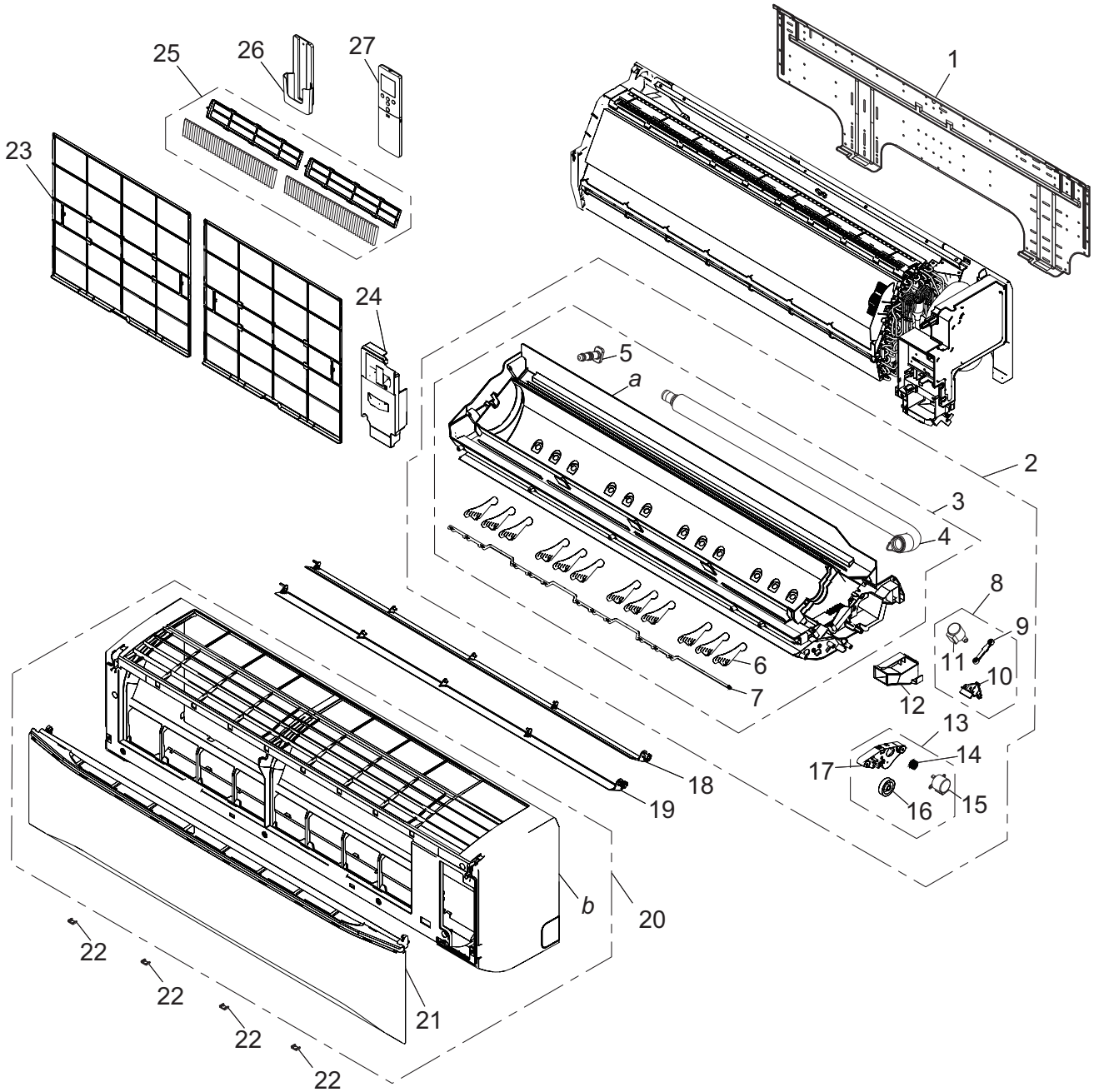

TECHNICAL DATA  
AND PARTS LIST

TECHNICAL DATA  
AND PARTS LIST



Item no.	Part no.	Part name	Service part
1	9386990004	Bracket panel	◆
2	9387059021	Casing total assy	◆
3	9387060010	Casing assy	◆
4	9387056006	Drain hose assy	◆
5	9316177017	Drain cap	◆
6	9386968003	R and L louver	◆
7	9386969000	Joint B	◆
8	9387063004	Link holder assy	◆
9	9386972000	Link A	◆
10	9315007018	Link holder	◆
11	9900139186	Step motor	◆
12	9386997003	Cable guide	◆
13	9387062007	Gear cover assy	◆
14	9309994003	Gear A	◆
15	9900384234	Step motor	◆
16	9317648004	Louver gear	◆
17	9386970006	Gear cover A	◆
18	9386958004	Louver U	◆
19	9386959001	Louver Z	◆
20	9387072181	Front panel total assy	◆
21	9382114008	Intake grille assy	◆
22	9386986007	Screw cap	◆
23	9386960007	Air filter	◆
24	9387074017	Wire cover assy	◆
25	9315212016	Air clean filter assy	◆
26	9318912005	Remote controller holder	◆
27	9383712005	Remote controller	◆
<i>a</i>	—	Casing	—
<i>b</i>	—	Front panel	—

# Evaporator and control

TECHNICAL DATA  
AND PARTS LIST

TECHNICAL DATA  
AND PARTS LIST

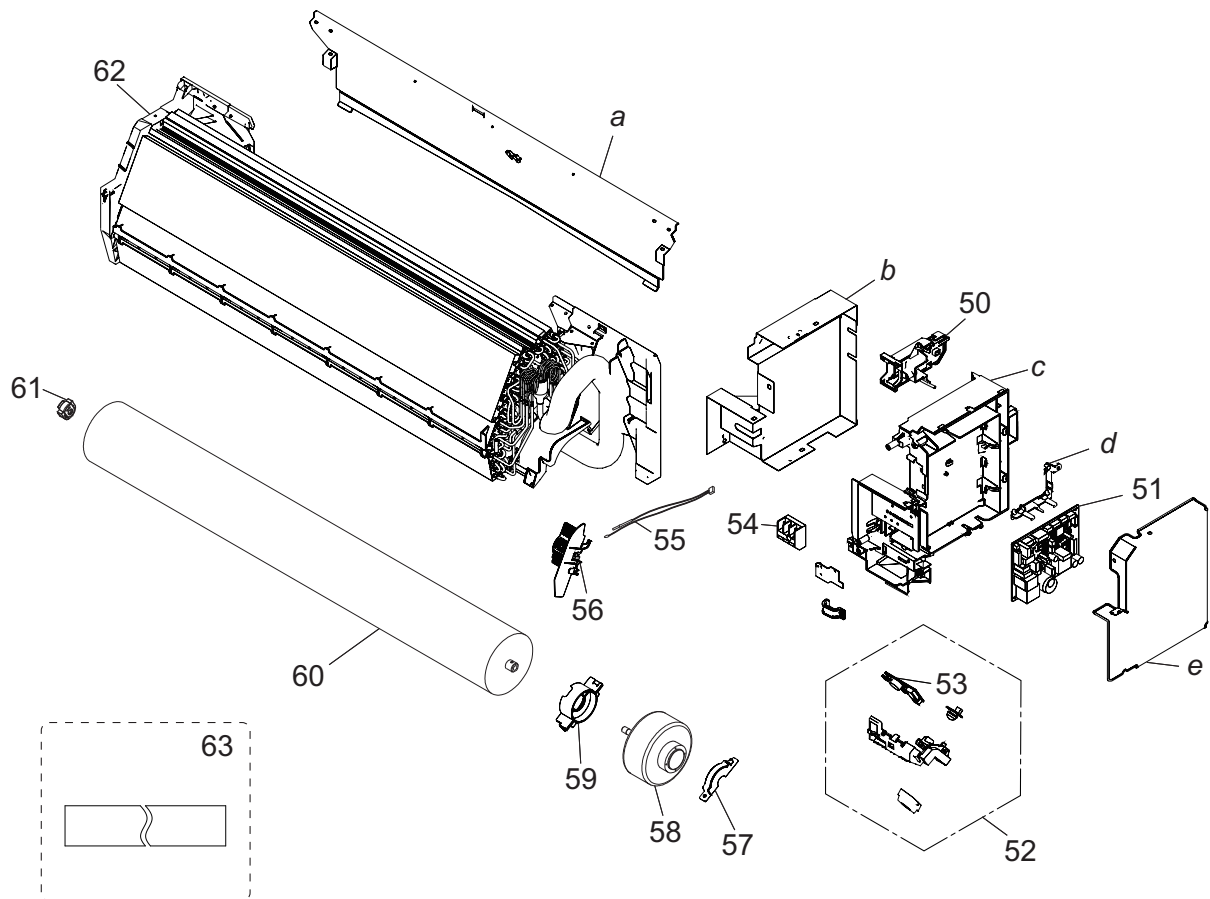

Item no.	Part no.	Part name	Service part
50	9383765025	WLAN adapter holder assy	◆
51	9711141385	Main PCB (For 30 model)	◆
	9711141378	Main PCB (For 36 model)	◆
52	9711146045	Display assy	◆
53	9711147035	Indicator PCB	◆
54	9306489045	Terminal	◆
55	9900627027	Thermistor assy	◆
56	9386988001	Room thermistor holder	◆
57	9316568006	Motor cover	◆
58	9603839017	Brushless motor	◆
59	9316601000	Motor cover	◆
60	9387055009	Crossflow fan assy	◆
61	9306628017	Bearing C assy	◆
62	9387064070	Evaporator total assy	◆
63	9361756007	Insulation (drain)-T	◆
<i>a</i>	—	Rear panel	—
<i>b</i>	—	Box shield assy	—
<i>c</i>	—	Control box	—
<i>d</i>	—	PCB holder A	—
<i>e</i>	—	Control cover	—

### 3. Outdoor unit parts list

#### 3-1. Models: AOYG30KMTA and AOYG36KMTA

##### ■ Exterior parts and chassis

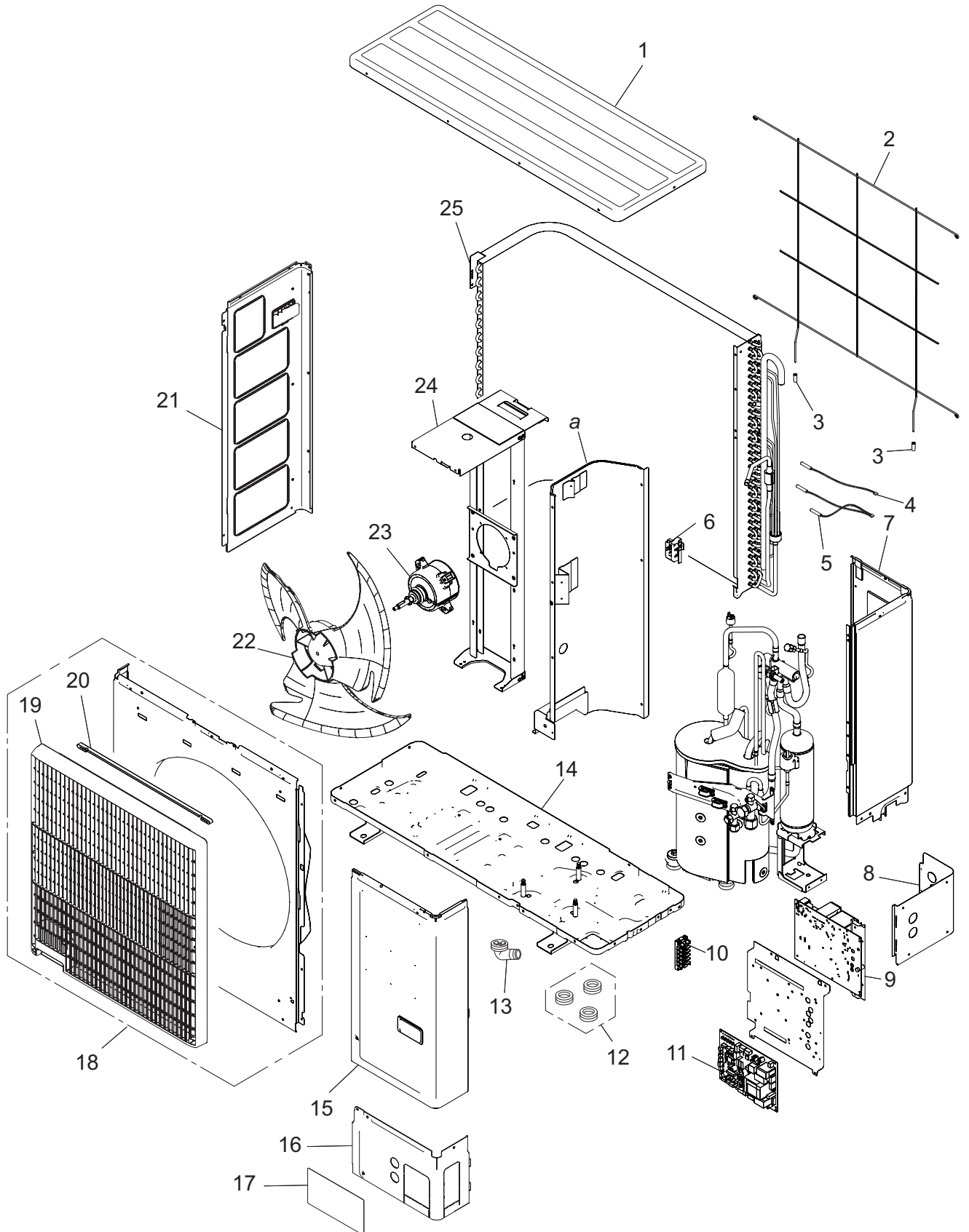

TECHNICAL DATA  
AND PARTS LIST

TECHNICAL DATA  
AND PARTS LIST

Item no.	Part no.	Part name	Service part
1	9383880001	Top panel assy	◆
2	9383779008	Protective net	◆
3	9375361013	Net rubber	◆
4	9900984038	Thermistor (Heat exchanger)	◆
5	9900727154	Thermistor assy	◆
6	9383607004	Thermo holder	◆
7	9383874000	Right panel sub assy	◆
8	9383879005	Rear pipe cover	◆
9	9709684108	Inverter PCB	◆
10	9900203061	Terminal	◆
11	9711431165	Main PCB (Service) (for 30 model)	◆
	9711431172	Main PCB (Service) (for 36 model)	◆
12	313166024302	Drain cap	◆
13	9303029015	Drain assy	◆
14	9350255009	Base assy	◆
15	9383876004	Service panel sub assy	◆
16	9383878008	Front pipe cover	◆
17	9351355005	Emblem rear	◆
18	9383863004	Front panel assy	◆
19	9383604003	Blow grille	◆
20	9383689000	Blow grille insulation	◆
21	9383882005	Left panel sub assy	◆
22	9383336003	Propeller fan	◆
23	9603732011	Brushless motor	◆
24	9383862007	Motor bracket assy	◆
25	9374420612	Condenser sub assy	◆
<i>a</i>	—	Separate wall assy	—

# Compressor

TECHNICAL DATA  
AND PARTS LIST

TECHNICAL DATA  
AND PARTS LIST

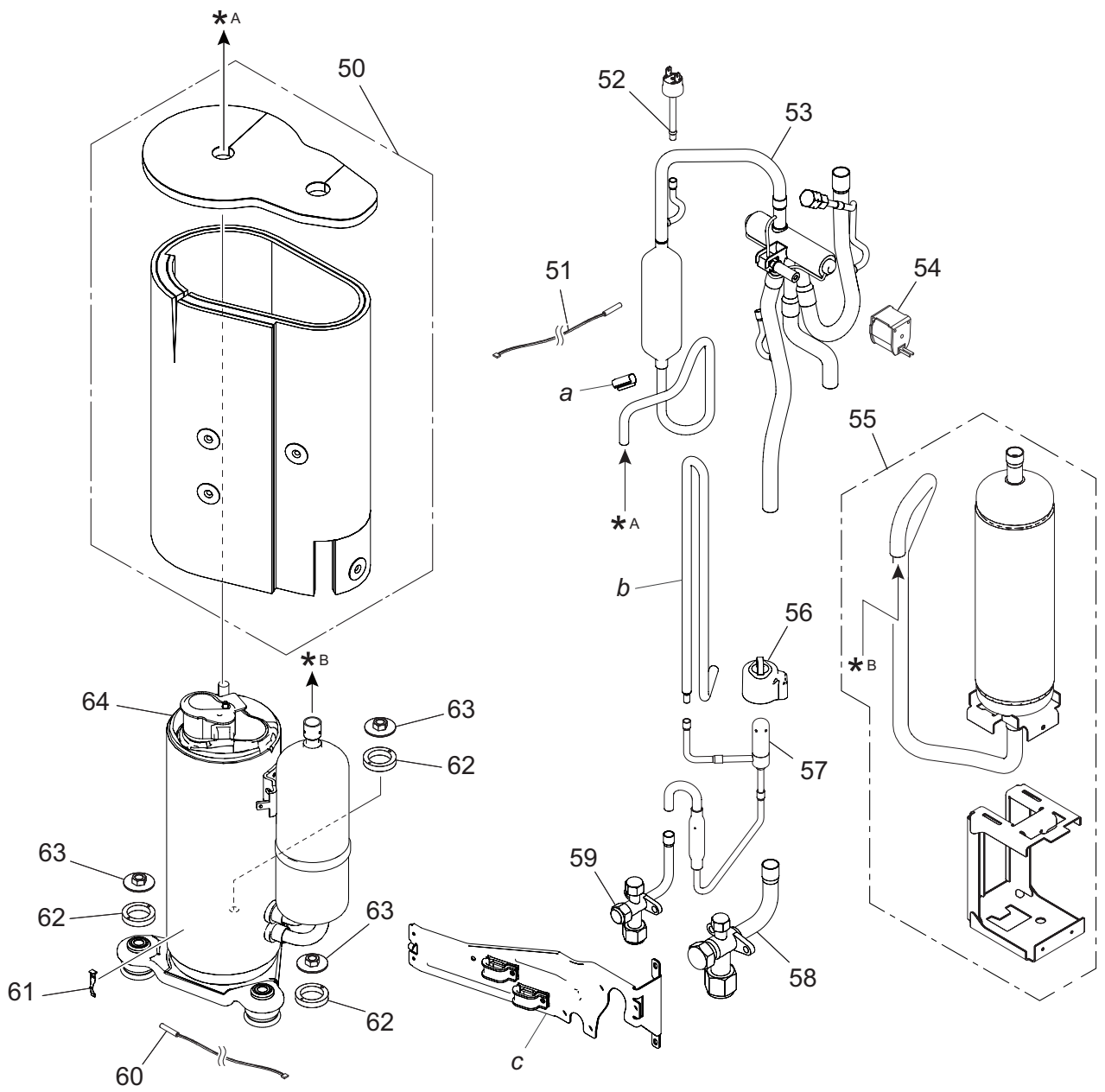









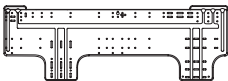

Item no.	Part no.	Part name	Service part
50	9383858000	Sound insulation unit	◆
51	9900565091	Thermistor (Outdoor temp.)	◆
52	9900186029	Pressure switch	◆
53	9374425648	4-way valve assy	◆
54	9970194016	Solenoid	◆
55	9375250140	Accumulator assy	◆
56	9970209000	Expansion valve coil	◆
57	9370947328	Expansion valve assy	◆
58	9379079013	3-way valve assy	◆
59	9377958037	3-way valve assy	◆
60	9900985035	Thermistor (Compressor)	◆
61	9810028006	Thermistor stopper	◆
62	9379179072	Rubber washer E	◆
63	9377973016	Special nut	◆
64	9383821004	Compressor assy	◆
<i>a</i>	—	Thermostat holder	—
<i>b</i>	—	Joint pipe D	—
<i>c</i>	—	Wiring fixation unit	—

## 4. Accessories



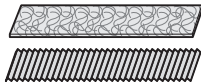

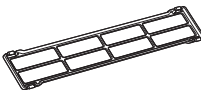
### 4-1. Indoor unit

#### ■ Models: ASYG30KMTA and ASYG36KMTA

Part name	Exterior	Q'ty	Part name	Exterior	Q'ty
Operating manual		1	Drain hose insulation		1
Installation manual		1	Cloth tape		1
Wall hook bracket		1	Tapping screw (large)		8
Remote controller		1	Tapping screw (small)		2
Battery		2	Air cleaning filters		1
Remote controller holder		1	Filter holder		2

### 4-2. Outdoor unit

#### ■ Models: AOYG30KMTA and AOYG36KMTA



Part name	Exterior	Q'ty	Part name	Exterior	Q'ty
Installation manual		1	Drain cap		3
Drain pipe		1	One-touch bush		2



## 5. Optional parts

### 5-1. Indoor unit

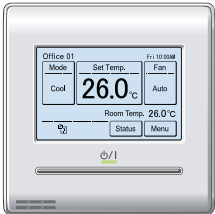
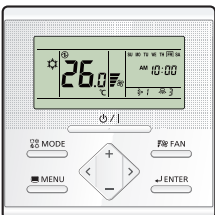
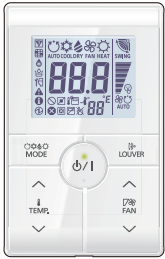



#### ■ Controllers

Exterior	Part name	Model name	Summary
	Wired remote controller	UTY-RNRYZ*	Easy finger touch operation with LCD panel. Backlit LCD enables easy operation in a dark room. Wire type: Non-polar 2-wire Optional communication kit is necessary for installation.
	Wired remote controller	UTY-RLRY	High visibility and easy operation. Room temperature can be accurately controlled using the built-in thermo sensor. Wire type: Non-polar 2-wire Optional communication kit is necessary for installation.
	Simple remote controller	UTY-RSRY	Compact remote controller concentrates on the basic functions such as Start/Stop, fan control, temperature setting, and operation mode. Wire type: Non-polar 2-wire Optional communication kit is necessary for installation.
	Simple remote controller	UTY-RHRY	Compact remote controller concentrates on the basic functions such as Start/Stop, fan control, and temperature setting. Wire type: Non-polar 2-wire Optional communication kit is necessary for installation.

#### NOTES:

- Available functions may differ by the remote controller. For details, refer to the operation manual.
- When using a Wireless LAN adapter, group controlling system of the wired remote controller is prohibited.

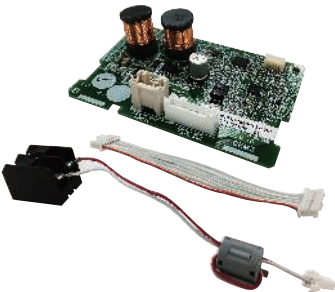
## Others

Exterior	Part name	Model name	Summary
	External connect kit	UTY-XWZXZ5	Required when external device is connected.
	External input and output PCB	UTY-XCSXZ2	Use to connect with external devices and air conditioner PCB. Optional External connect kit is necessary for installation.
	Communication kit	UTY-TWRXZ2	Use to connect Non-polar 2-core wired remote controller.
	Wireless LAN adapter	UTY-TFSXF2	Remotely manage an air conditioning system using mobile devices such as smartphones and tablets.

## 6. Refrigerant system diagrams

### 6-1. Models: AOYG30KMTA and AOYG36KMTA

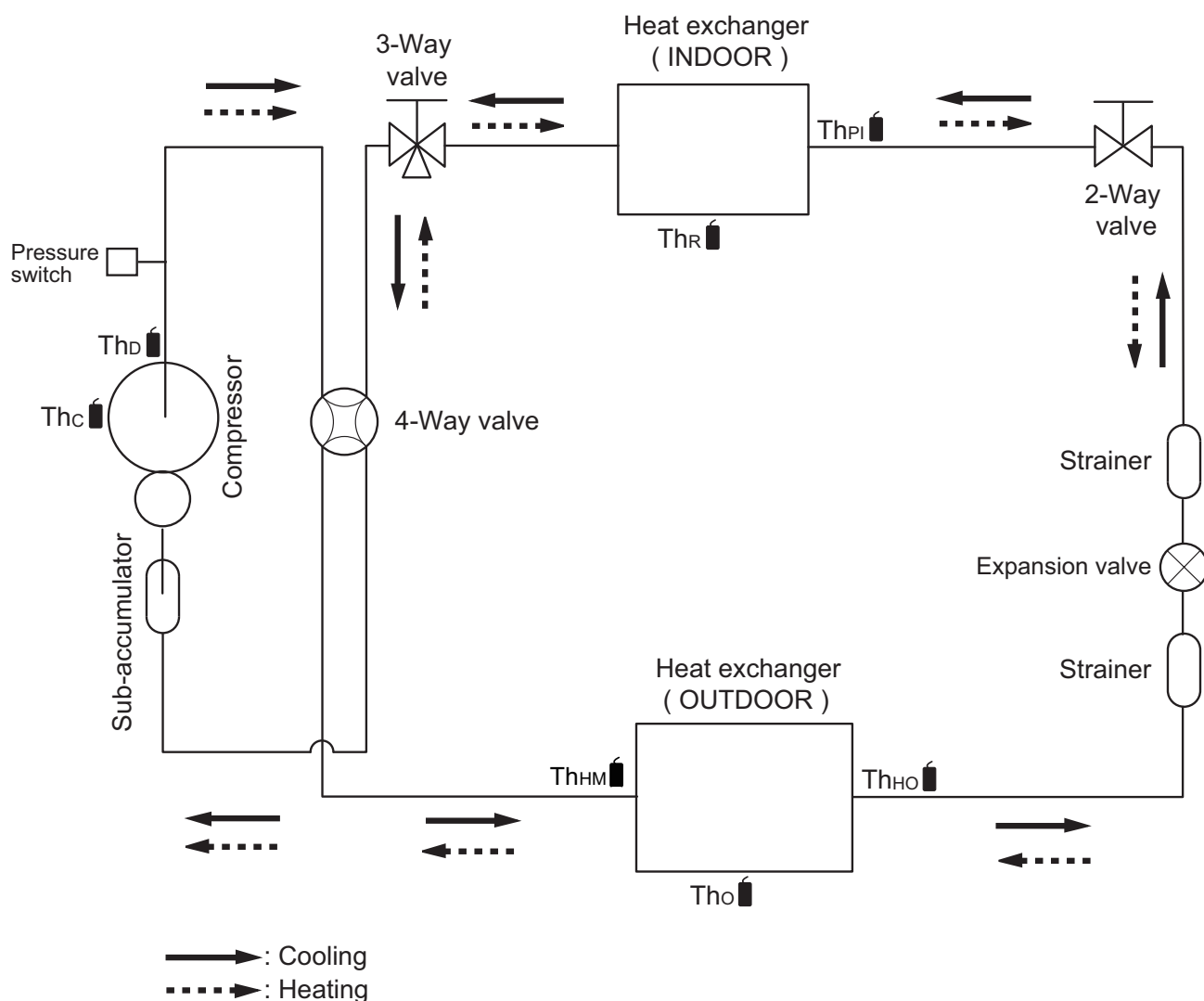

Th<sub>c</sub> : Thermistor (Compressor temperature)

Th<sub>d</sub> : Thermistor (Discharge temperature)

Th<sub>HM</sub> : Thermistor (Heat Exchanger Med temperature)

Th<sub>o</sub> : Thermistor (Outdoor temperature)

Th<sub>HO</sub> : Thermistor (Heat Exchanger Out temperature)

Th<sub>R</sub> : Thermistor (Room temperature)

Th<sub>PI</sub> : Thermistor (Pipe temperature)

# 7. Wiring diagrams

## 7-1. Indoor unit

### Models: ASYG30KMTA and ASYG36KMTA

TECHNICAL DATA  
AND PARTS LIST

TECHNICAL DATA  
AND PARTS LIST

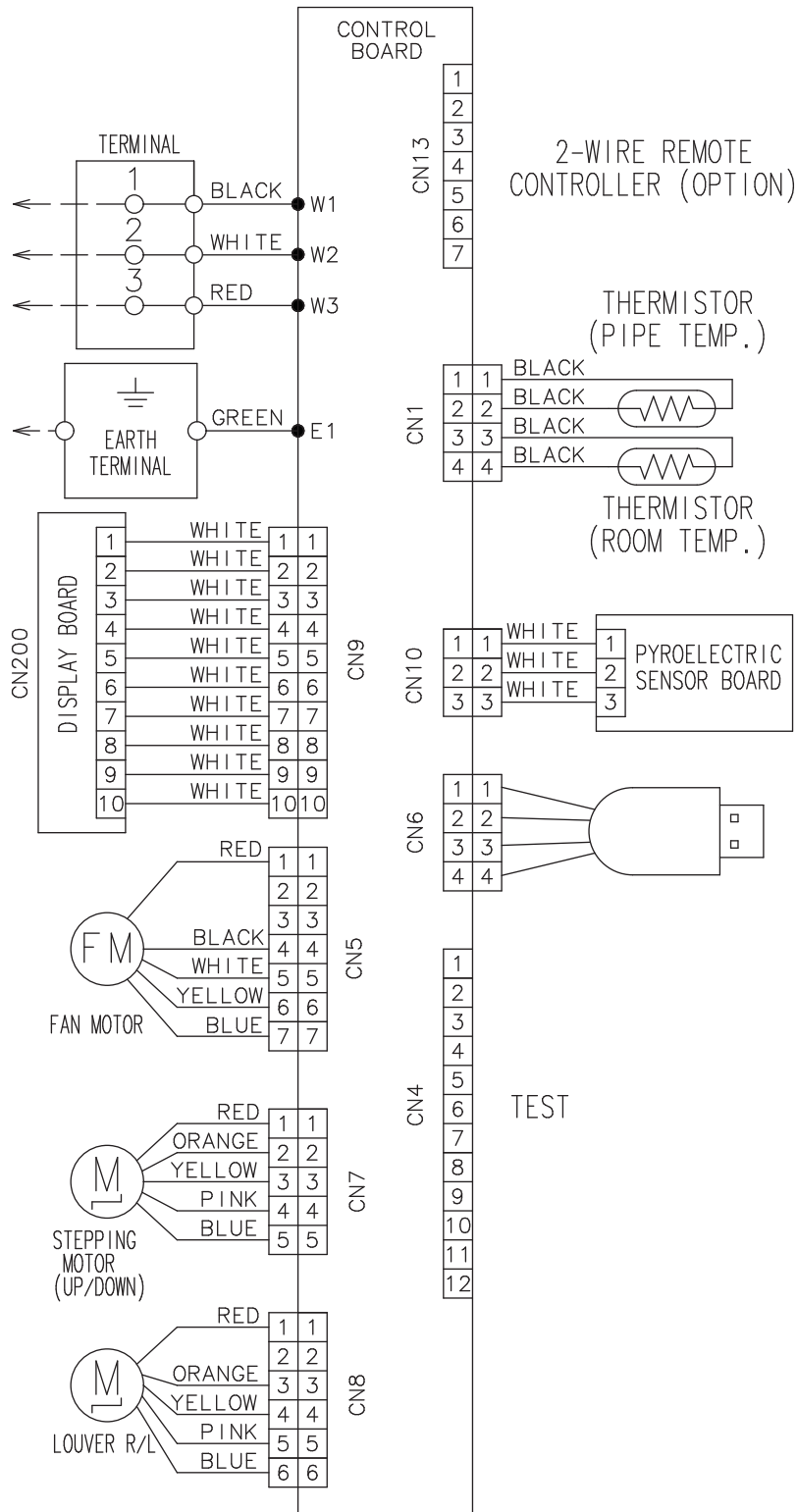

# 7-2. Outdoor unit

## Models: AOYG30KMTA and AOYG36KMTA

TECHNICAL DATA  
AND PARTS LIST

TECHNICAL DATA  
AND PARTS LIST

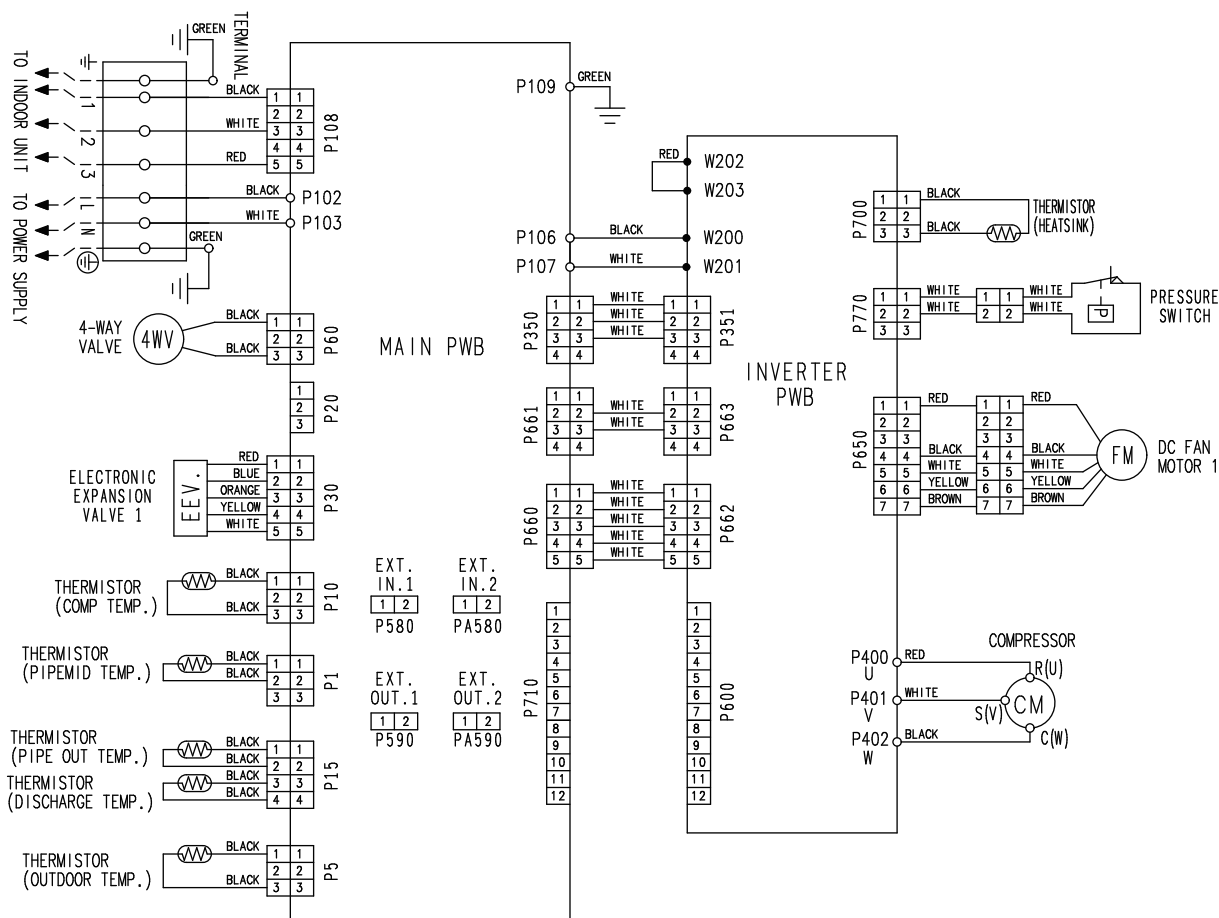

# 8. PC board diagrams

## 8-1. Models: ASYG30KMTA and ASYG36KMTA

TECHNICAL DATA AND PARTS LIST

TECHNICAL DATA AND PARTS LIST

CONTROL UNIT  
30 model : EZ-01909HSE  
36 model : EZ-0190AHSE

CN5 DC Fan motor

Pin No.	Terminal code	Function of terminal	Lead wire color
1	Vm	Motor power voltage input	Red
2	—	—	—
3	—	—	—
4	GND	GND	Black
5	Vcc	Control power voltage input	White
6	Vsp	Speed control voltage input	Yellow
7	FG	Revolution pulse output	Blue

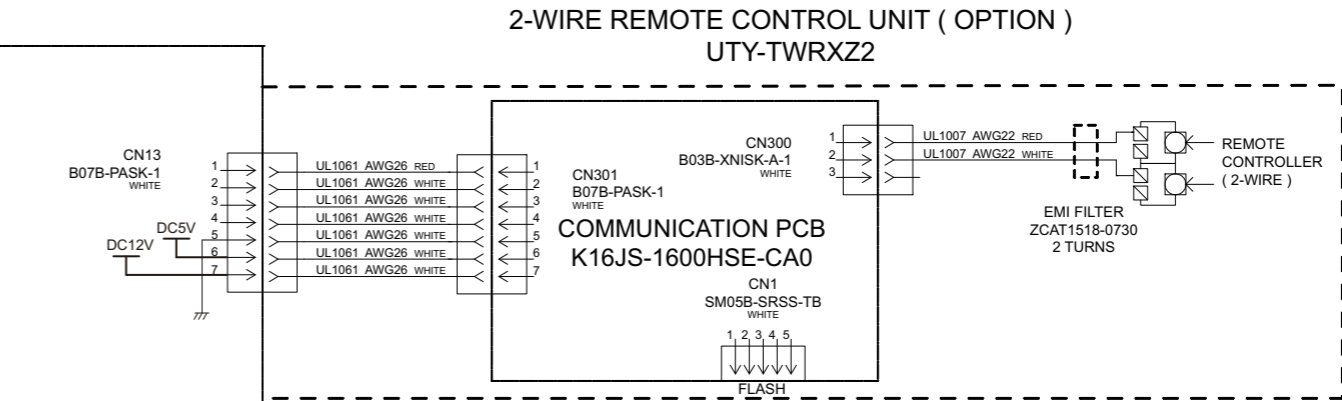
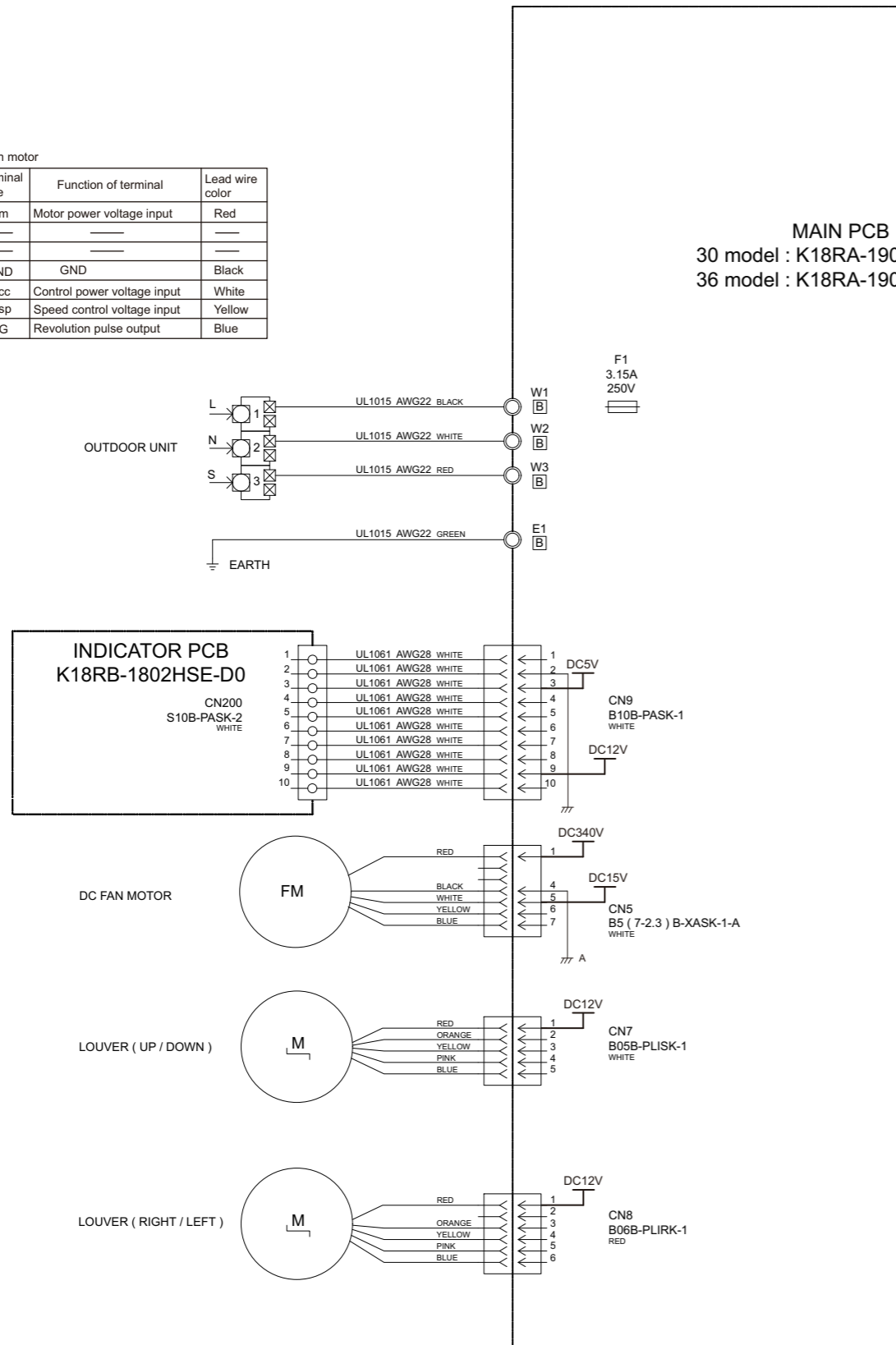

CN1 Thermistor Characteristics.

Thermistor	Temperature	( 0°C )	( 20°C )	( 30°C )
Thermistor ( Pipe temp. )	Resistance	176.03 k Ω	62.91 k Ω	39.57 k Ω
	Voltage	1.10 V	2.21 V	2.79 V
Thermistor ( Room temp. )	Resistance	33.62 k Ω	12.54 k Ω	8.04 k Ω
	Voltage	1.15 V	2.22 V	2.77 V

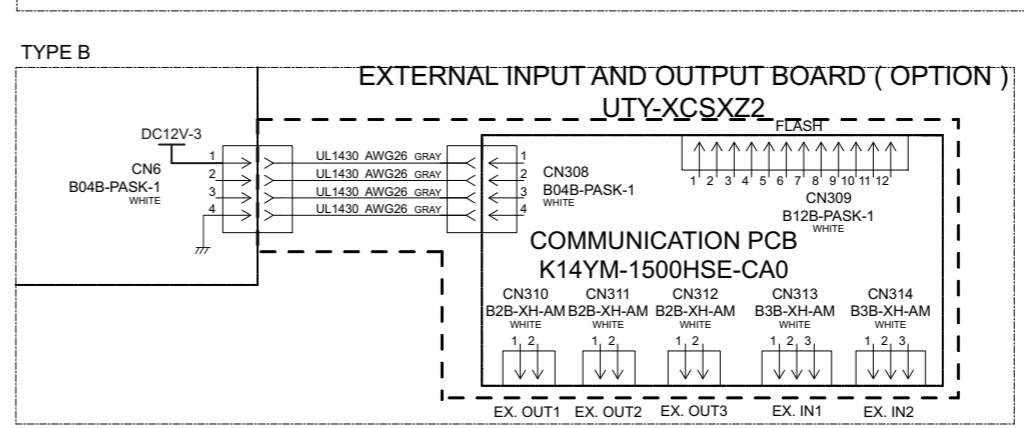
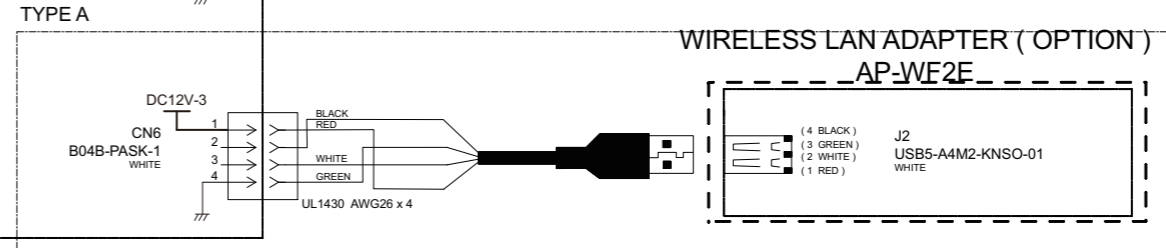
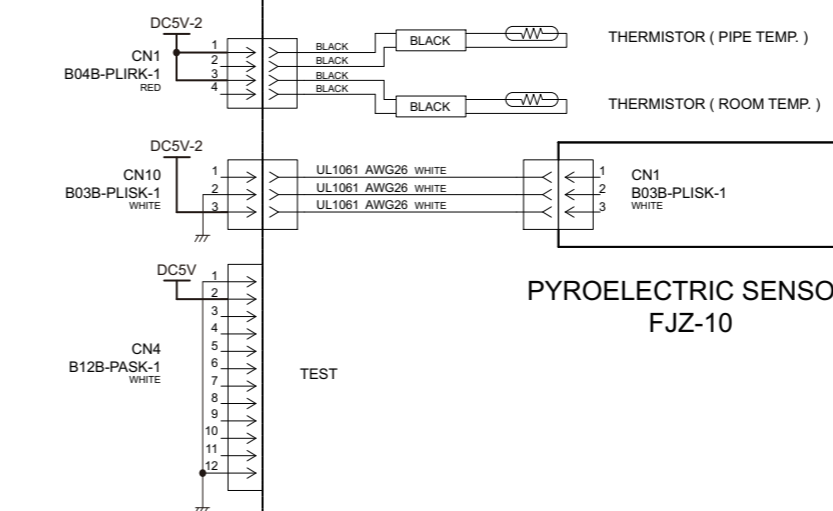

# 8-2. Models: AOYG30KMTA and AOYG36KMTA

## INVERTER ASSEMBLY EZ-01915HUE

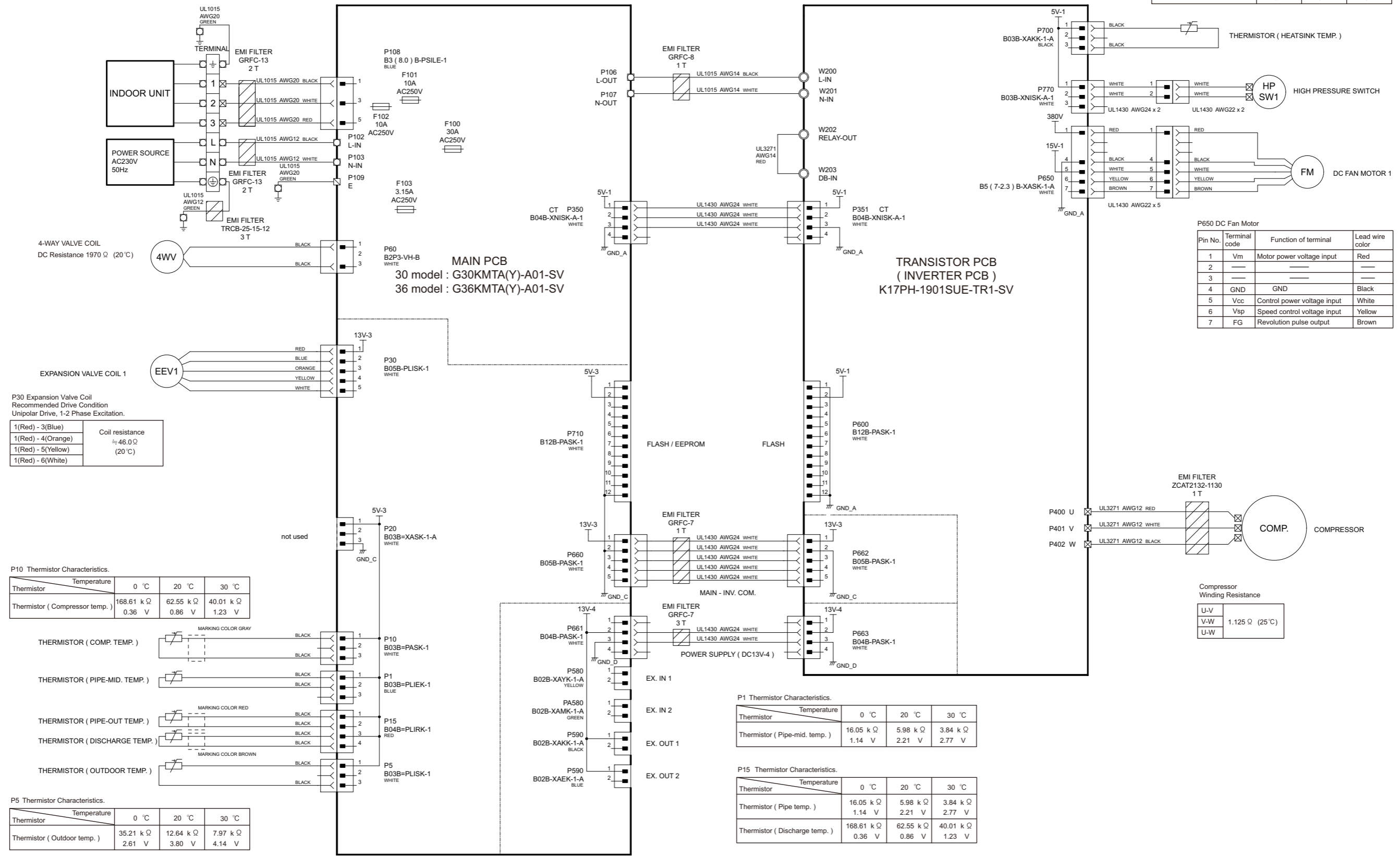

TECHNICAL DATA AND PARTS LIST

TECHNICAL DATA AND PARTS LIST





## 3. TROUBLESHOOTING

# CONTENTS

## 3. TROUBLESHOOTING

<b>1. Error code .....</b>	<b>03-1</b>
1-1. How to check the error memory.....	03-1
1-2. How to erase the error memory .....	03-1
1-3. Error code table (Indoor unit and wired remote controller).....	03-2
1-4. Error code table (Outdoor unit: for 36 model only).....	03-3
<b>2. Troubleshooting with error code .....</b>	<b>03-5</b>
2-1. E: 11. Serial communication error (Serial reverse transfer error) (Outdoor unit).....	03-5
2-2. E: 11. Serial communication error (Serial forward transfer error) (Indoor unit) .....	03-7
2-3. E: 12. Wired remote controller communication error (Indoor unit) .....	03-9
2-4. E: 22. Indoor unit capacity error (Indoor unit) .....	03-10
2-5. E: 32. Indoor unit main PCB error (Indoor unit) .....	03-11
2-6. E: 35. MANUAL AUTO button error (Indoor unit).....	03-12
2-7. E: 41. Room temperature sensor error (Indoor unit).....	03-13
2-8. E: 42. Indoor unit heat exchanger sensor error (Indoor unit) .....	03-14
2-9. E: 51. Indoor unit fan motor error (Indoor unit) .....	03-15
2-10. E: 62. Outdoor unit main PCB error (Outdoor unit).....	03-16
2-11. E: 63. Inverter error (Outdoor unit).....	03-17
2-12. E: 64. PFC circuit error (Outdoor unit) .....	03-18
2-13. E: 65. Trip terminal L error (Outdoor unit).....	03-19
2-14. E: 71. Discharge thermistor error (Outdoor unit).....	03-20
2-15. E: 73. Heat exchanger (Middle/Outlet) temperature thermistor error (Outdoor unit) ...	03-21
2-16. E: 74. Outdoor temperature thermistor error (Outdoor unit).....	03-22
2-17. E: 77. Heat sink thermistor error (Outdoor unit).....	03-23
2-18. E: 84. Current sensor error (Outdoor unit) .....	03-24
2-19. E: 86. High pressure switch error (Outdoor unit) .....	03-25
2-20. E: 86. High pressure switch error (Outdoor unit)(For 36 model) .....	03-26
2-21. E: 94. Trip detection (Outdoor unit).....	03-27
2-22. E: 95. Compressor motor control error (Outdoor unit) .....	03-28
2-23. E: 97. Outdoor unit fan motor error (Outdoor unit).....	03-29
2-24. E: 99. 4-way valve error (Outdoor unit).....	03-31
2-25. E: A1. Discharge temperature error (Outdoor unit).....	03-33
2-26. E: A5. Low pressure error (Outdoor unit).....	03-35
2-27. E: AC. Heat sink temperature error (Outdoor unit).....	03-37
<b>3. Troubleshooting without error code.....</b>	<b>03-38</b>
3-1. Indoor unit—No power.....	03-38
3-2. Outdoor unit—No power .....	03-39
3-3. No operation (Power is on).....	03-40
3-4. No cooling/No heating .....	03-41
3-5. Abnormal noise.....	03-43
3-6. Water leaking.....	03-44
<b>4. Service parts information .....</b>	<b>03-45</b>

## CONTENTS (continued)

4-1. Compressor .....	03-45
4-2. Inverter compressor .....	03-46
4-3. Outdoor unit Electronic Expansion Valve (EEV) .....	03-47
4-4. Indoor unit fan motor .....	03-49
4-5. Outdoor unit fan motor .....	03-50
4-6. Pressure switch .....	03-51
4-7. 4-way valve coil (solenoid coil)/4-way valve .....	03-52
<b>5. Thermistor resistance values .....</b>	<b>03-53</b>
5-1. Indoor unit .....	03-53
5-2. Outdoor unit .....	03-54



## 1. Error code

When a problem occurs in the system or the connected device, the error content is notified by displaying the code.

**NOTE:** This function is only available in a system with indoor or IR receiver units equipped with LED lamps to indicate the error content.

Errors, once displayed, will be automatically stored in the PC board of the indoor unit. Even if the power is disconnected, the memory containing the error history will not be erased.

If another error occurs later, the stored error memory will be updated automatically and replaced with the new one. (Previous error will be erased.)

### 1-1. How to check the error memory

When an error occurs, the operation lamp (Green) and the timer lamp (Orange) indicate the error content by blinking. To check the error memory, follow the procedures below.

1. Stop the operation of the air conditioner, and then disconnect the power supply.
2. Reconnect the power supply.
3. In one of the following two methods, the memorized error is only displayed during the “3 minutes ST”<sup>\*</sup> state period.
  - Start the operation and then press the TEST RUN button on the remote controller.
  - Press the MANUAL AUTO button on the indoor unit for 10 seconds or more.

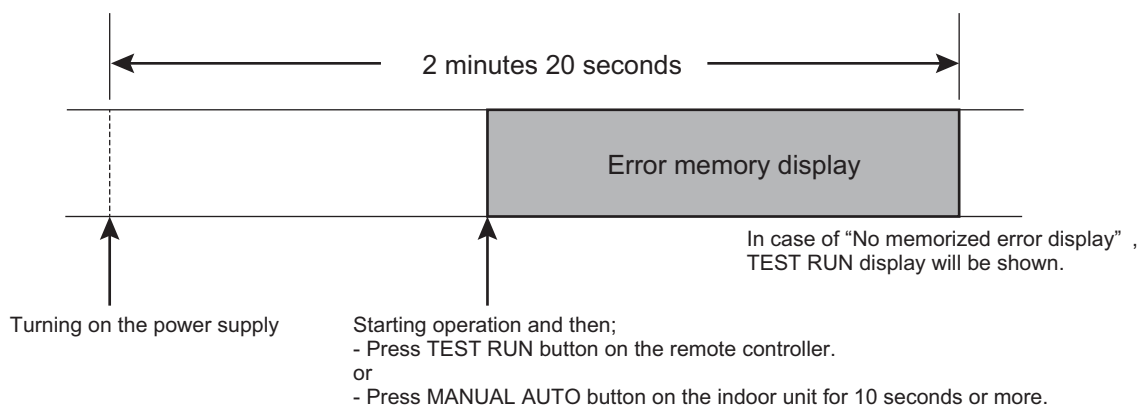

\*: The “3 minutes ST” period lasts 2 minutes and 20 seconds after turning on the power supply.

### 1-2. How to erase the error memory

The error memory can be erased in one of the following two methods.

- Manual erase: Pressing the MANUAL AUTO button on the indoor unit while the “Error memory display” is being shown. (Short beep emits for about 3 seconds.)
- Automatic erase: After continuing the normal operation of the air conditioner without error for 2 hours or longer after displaying the error memory as described in [How to check the error memory](#). (Except FAN operation mode.)

## 1-3. Error code table (Indoor unit and wired remote controller)

The operation, timer, and economy indicators operate according to the error contents.

For confirmation of the error contents, refer the flashing pattern as follows.

Error contents	Indoor unit display			Wired remote controller display
	Operation [I] (Green)	Timer [⌚] (Orange)	Economy [E] (Green)	
E: 11. Serial communication error (Serial reverse transfer error) (Outdoor unit)	1 times	1 times	Continuous	11
E: 11. Serial communication error (Serial forward transfer error) (Indoor unit)	1 times	1 times	Continuous	11
E: 12. Wired remote controller communication error (Indoor unit)	1 times	2 times	Continuous	12
E: 22. Indoor unit capacity error (Indoor unit)	2 times	2 times	Continuous	22
E: 32. Indoor unit main PCB error (Indoor unit)	3 times	2 times	Continuous	32
E: 35. MANUAL AUTO button error (Indoor unit)	3 times	5 times	Continuous	35
E: 41. Room temperature sensor error (Indoor unit)	4 times	1 times	Continuous	41
E: 42. Indoor unit heat exchanger sensor error (Indoor unit)	4 times	2 times	Continuous	42
E: 51. Indoor unit fan motor error (Indoor unit)	5 times	1 times	Continuous	51
E: 62. Outdoor unit main PCB error (Outdoor unit)	6 times	2 times	Continuous	62
E: 63. Inverter error (Outdoor unit)	6 times	3 times	Continuous	63
E: 64. PFC circuit error (Outdoor unit)	6 times	4 times	Continuous	64
E: 65. Trip terminal L error (Outdoor unit)	6 times	5 times	Continuous	65
E: 71. Discharge thermistor error (Outdoor unit)	7 times	1 times	Continuous	71
E: 73. Heat exchanger (Middle/Outlet) temperature thermistor error (Outdoor unit)	7 times	3 times	Continuous	73
E: 74. Outdoor temperature thermistor error (Outdoor unit)	7 times	4 times	Continuous	74
E: 77. Heat sink thermistor error (Outdoor unit)	7 times	7 times	Continuous	77
E: 84. Current sensor error (Outdoor unit)	8 times	4 times	Continuous	84
E: 86. High pressure switch error (Outdoor unit)	8 times	6 times	Continuous	86
E: 86. High pressure switch error (Outdoor unit)(For 36 model)	8 times	6 times	Continuous	86
E: 94. Trip detection (Outdoor unit)	9 times	4 times	Continuous	94
E: 95. Compressor motor control error (Outdoor unit)	9 times	5 times	Continuous	95
E: 97. Outdoor unit fan motor error (Outdoor unit)	9 times	7 times	Continuous	97
E: 99. 4-way valve error (Outdoor unit)	9 times	9 times	Continuous	99
E: A1. Discharge temperature error (Outdoor unit)	10 times	1 times	Continuous	A1
E: A5. Low pressure error (Outdoor unit)	10 times	5 times	Continuous	A5
E: AC. Heat sink temperature error (Outdoor unit)	10 times	12 times	Continuous	AC

## 1-4. Error code table (Outdoor unit: for 36 model only)

The operation status is determined by the lighting up and blinking of the LED lamp.  
After check that ERROR LED lamp blinks, press the ENTER button once.

**NOTE:** For the positions of LED lamp and buttons, refer to "Function settings on outdoor unit" in Chapter 5. FIELD WORKING on page 05-7.

Error contents	POWER/ MODE	ERROR	PUMP DOWN	LOW NOISE		PEAK CUT		
			L1	L2	L3	L4	L5	L6
E: 11. Serial communication error (Serial forward transfer error) (Indoor unit)	■ 2	●	■ 1	■ 1	○	○	●	●
E: 11. Serial communication error (Serial forward transfer error) (Indoor unit)	■ 2	●	■ 1	■ 1	○	●	○	○
E: 12. Wired remote controller communication error (Indoor unit)	■ 2	●	■ 5	■ 15	○	○	○	●
E: 32. Indoor unit main PCB error (Indoor unit)	■ 2	●	■ 5	■ 15	○	○	○	●
E: 35. MANUAL AUTO button error (Indoor unit)	■ 2	●	■ 5	■ 15	○	○	○	●
E: 41. Room temperature sensor error (Indoor unit)	■ 2	●	■ 5	■ 15	○	○	○	●
E: 42. Indoor unit heat exchanger sensor error (Indoor unit)	■ 2	●	■ 5	■ 15	○	○	○	●
E: 51. Indoor unit fan motor error (Indoor unit)	■ 2	●	■ 5	■ 15	○	○	○	●
E: 62. Outdoor unit main PCB error (Outdoor unit)	■ 2	●	■ 6	■ 2	○	○	○	●
E: 63. Inverter error (Outdoor unit)	■ 2	●	■ 6	■ 3	○	○	○	●
E: 71. Discharge thermistor error (Outdoor unit)	■ 2	●	■ 7	■ 1	○	○	○	●
E: 73. Heat exchanger (Middle/Outlet) temperature thermistor error (Outdoor unit)	■ 2	●	■ 7	■ 3	○	○	●	○
E: 74. Outdoor temperature thermistor error (Outdoor unit)	■ 2	●	■ 7	■ 4	○	○	○	●
E: 77. Heat sink thermistor error (Outdoor unit)	■ 2	●	■ 7	■ 7	○	○	○	●
E: 84. Current sensor error (Outdoor unit)	■ 2	●	■ 8	■ 4	○	○	○	●
E: 86. High pressure switch error (Outdoor unit)	■ 2	●	■ 8	■ 6	○	●	●	○
E: 86. High pressure switch error (Outdoor unit)(For 36 model)	■ 2	●	■ 8	■ 6	○	●	●	○
E: 94. Trip detection (Outdoor unit)	■ 2	●	■ 9	■ 4	○	○	○	●
E: 95. Compressor motor control error (Outdoor unit)	■ 2	●	■ 9	■ 5	○	○	○	●
E: 97. Outdoor unit fan motor error (Outdoor unit)	■ 2	●	■ 9	■ 7	○	○	●	●
E: 99. 4-way valve error (Outdoor unit)	■ 2	●	■ 9	■ 9	○	○	○	●
E: A1. Discharge temperature error (Outdoor unit)	■ 2	●	■ 10	■ 1	○	○	○	●

Error contents	POWER/ MODE	ERROR	PUMP DOWN	LOW NOISE			PEAK CUT		
			L1	L2	L3	L4	L5	L6	
E: A5. Low pressure error (Outdoor unit)	■ 2	●	■ 10	■ 5	○	○	○	●	
E: AC. Heat sink temperature error (Outdoor unit)	■ 2	●	■ 10	■ 12	○	○	●	●	

● : Light on    ○ : Light off    ■ (n) : n Times blinking



## 2. Troubleshooting with error code

### 2-1. E: 11. Serial communication error (Serial reverse transfer error) (Outdoor unit)

Indicator	Indoor unit	Operation indicator	1 time flash
		Timer indicator	1 time flash
		Economy indicator	Continuous flash
		Error code	E: 11
	outdoor unit	Refer to " <a href="#">Error code table (Outdoor unit: for 36 model only)</a> " on page 03-3	
Detective actuator	Outdoor unit	Main PCB	When the indoor unit cannot receive the serial signal from outdoor unit more than 2 minutes after power on, or the indoor unit cannot receive the serial signal more than 15 seconds during normal operation.
		Fan motor	
Forecast of cause		Connection failure	
		External cause	
		Main PCB failure	
		Outdoor unit fan motor failure	

Check point 1. Reset the power and operate

Does error indication show again?

→ If no, go to "[Check point 1-2](#)".



Check point 2. Check connection

Check any loose or removed connection line of indoor unit and outdoor unit.

Check connection condition is control unit. (If there is loose connector, open cable or mis-wiring.)

→ If there is an abnormal condition, correct it by referring to the installation manual or the "DESIGN & TECHNICAL MANUAL".



Check point 3. Check the voltage of power supply

Check the voltage of power supply

Check if AC 198 V (AC 220 V -10%) to AC 264 V (AC 240 V +10%) appears at outdoor unit terminal L - N.

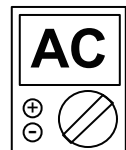

## Check point 4. Check serial signal (Reverse transfer signal)

Check serial signal (Reverse transfer signal)

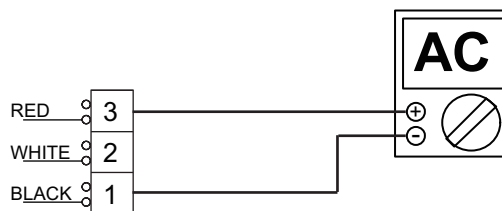

- Check if indicated value swings between AC 90 V and AC 270 V at the outdoor unit terminal 1—3.
- If it is abnormal, check the parts below.
  - Outdoor unit fan motor in "[Service parts information](#)" on page 03-45
- If outdoor fan motor is abnormal, replace outdoor unit fan motor and main PCB.
- If the checked parts are normal, replace the main PCB.



**End**

## Check point 1-2. Check external cause such as noise

- Check the complete insulation of the grounding.
- Check if there is any equipment that causes harmonic wave near the power cable (Neon light bulb or any electronic equipment which causes harmonic wave).



**End**

## 2-2. E: 11. Serial communication error (Serial forward transfer error) (Indoor unit)

Indicator	Indoor unit	Operation indicator	1 time flash
		Timer indicator	1 time flash
		Economy indicator	Continuous flash
		Error code	E: 11
	outdoor unit	Refer to " <a href="#">Error code table (Outdoor unit: for 36 model only)</a> " on page 03-3	
Detective actuator	Indoor unit	Main PCB	When the outdoor unit cannot receive the serial signal from indoor unit more than 10 seconds.
		Fan motor	
	Outdoor unit	Main PCB	
Forecast of cause			Connection failure
			External cause
			Main PCB failure
			Indoor unit fan motor failure
			Outdoor unit Main PCB

Check point 1. Reset the power and operate

Does error indication show again?

→ If no, go to "[Check point 1-2](#)".



Check point 2. Check connection

Check any loose or removed connection line of indoor unit and outdoor unit.

Check connection condition is control unit. (If there is loose connector, open cable or mis-wiring.)

→ If there is an abnormal condition, correct it by referring to the installation manual or the "DESIGN & TECHNICAL MANUAL".



Check point 3. Check the voltage of power supply

Check the voltage of power supply

Check if AC 198 V (AC 220 V -10%) to AC 264 V (AC 240 V +10%) appears at outdoor unit terminal L - N.

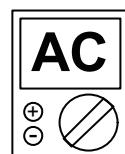

## Check point 4. Check serial signal (Forward transfer signal)

Check serial signal (Forward transfer signal)

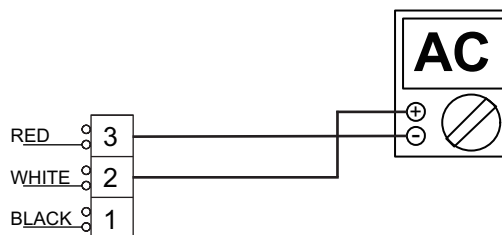

- Check if indicated value swings between AC 30 V and AC 130 V at outdoor unit terminal 2—3.
- If it is abnormal, replace main PCB.
- If it is abnormal, check indoor unit fan motor. (Indoor unit fan motor in "[Service parts information](#)" on page 03-45)
- If indoor unit fan motor is abnormal, replace indoor unit fan motor and main PCB.
- If it is abnormal, replace outdoor unit main PCB.



**End**

## Check point 1-2. Check external cause such as noise

- Check the complete insulation of the grounding.
- Check if there is any equipment that causes harmonic wave near the power cable (Neon light bulb or any electronic equipment which causes harmonic wave).



**End**

## 2-3. E: 12. Wired remote controller communication error (Indoor unit)

Indicator	Indoor unit	Operation indicator	1 time flash
		Timer indicator	2 time flash
		Economy indicator	Continuous flash
		Error code	E: 12
	outdoor unit	Refer to " <a href="#">Error code table (Outdoor unit: for 36 model only)</a> " on page 03-3	
Detective actuator	Indoor unit	Main PCB	When the indoor unit cannot receive the signal from Wired remote controller more than 1 minute during normal operation.
	Wired remote control		
Forecast of cause			Terminal connection abnormal
			Wired remote control failure
			Main PCB failure

### Check point 1. Check the connection of terminal

After turning off the power, check & correct the followings.

- Check the connection of terminal between remote controller and indoor unit, and check if there is a disconnection of the cable.



### Check point 2. Check connection

Check voltage at CN14 of main PCB (terminal 1—3). (Power supply to the remote controller)

Upon correcting the removed connector or mis-wiring, reset the power.



- If it is DC 12 V, remote controller is failure. (Main PCB is normal)
  - Replace Remote Control
- If it is DC 0 V, main PCB is failure. (Check remote controller once again)
  - Replace main PCB



**End**

## 2-4. E: 22. Indoor unit capacity error (Indoor unit)

Indicator	Indoor unit	Operation indicator	2 time flash
		Timer indicator	2 time flash
		Economy indicator	Continuous flash
		Error code	E: 22
	outdoor unit	Refer to " <a href="#">Error code table (Outdoor unit: for 36 model only)</a> " on page 03-3	
Detective actuator	Indoor unit main PCB		When the total capacity of the indoor units does not match outdoor unit capacity while 3 minutes after power on.
Forecast of cause		Indoor unit selection is incorrect.	
		Main PCB failure	

Check point 1. Check the total capacity of indoor units

Check the total capacity of the indoor units.

→ If abnormal condition is found, correct it referring to the installation manual or DESIGN & TECHNICAL MANUAL.



Check point 2. Replace main PCB

If check point 1 does not improve the symptom, change main PCB.



**End**

## 2-5. E: 32. Indoor unit main PCB error (Indoor unit)

Indicator	Indoor unit	Operation indicator	3 time flash
		Timer indicator	2 time flash
		Economy indicator	Continuous flash
		Error code	E: 32
	outdoor unit	Refer to " <a href="#">Error code table (Outdoor unit: for 36 model only)</a> " on page 03-3	
Detective actuator	Indoor unit	main PCB	When power is on and there is some below case. 1. When model information of EEPROM is incorrect. 2. When the access to EEPROM failed.
Forecast of cause			External cause
			Defective connection of electric components
			Main PCB failure

Check point 1. Reset power supply and operate

Does error indication show again?

→ If no, go to "[Check point 1-2](#)".



Check point 2. Check Indoor unit electric components

- Check all connectors. (loose connector or incorrect wiring)
- Check any shortage or corrosion on PCB.



Check point 3. Replace main PCB

Change main PCB.



**End**

Check point 1-2. Check external cause such as noise

- Check if the ground connection is proper.
- Check if there is any equipment that causes harmonic wave near the power cable (Neon light bulb or any electronic equipment which causes harmonic wave).



**End**

### NOTE: EEPROM

EEPROM (Electrically Erasable and Programmable Read Only Memory) is a non-volatile memory which keeps memorized information even if the power is turned off. It can change the contents electronically. To change the contents, it uses higher voltage than normal, and it cannot change a partial contents. (Rewriting shall be done upon erasing the all contents.) There is a limit in a number of rewriting.

## 2-6. E: 35. MANUAL AUTO button error (Indoor unit)

Indicator	Indoor unit	Operation indicator	3 time flash
		Timer indicator	5 time flash
		Economy indicator	Continuous flash
		Error code	E: 35
	outdoor unit	Refer to " <a href="#">Error code table (Outdoor unit: for 36 model only)</a> " on page 03-3	
Detective actuator	Indoor unit controller PCB	When the MANUAL AUTO button becomes on for consecutive 60 or more seconds.	
	Indicator PCB		
	Manual auto switch		
Forecast of cause	MANUAL AUTO button failure		
	Controller PCB and indicator PCB failure		

Check point 1. Check the MANUAL AUTO button

- Check if MANUAL AUTO button is kept pressed.
- Check On/Off switching operation by using a meter.



If MANUAL AUTO button is disabled (on/off switching), replace it.



Check point 2. Replace main PCB and indicator PCB

If Check Point 1 does not improve the symptom, change main PCB and indicator PCB.



**End**



## 2-7. E: 41. Room temperature sensor error (Indoor unit)

Indicator	Indoor unit	Operation indicator	4 time flash
		Timer indicator	1 time flash
		Economy indicator	Continuous flash
		Error code	E: 41
	outdoor unit	Refer to " <a href="#">Error code table (Outdoor unit: for 36 model only)</a> " on page 03-3	
Detective actuator	Indoor unit main PCB	Room temperature thermistor is open or short is detected always.	
	Room temperature thermistor		
Forecast of cause		Connector failure	
		Thermistor failure	
		Main PCB failure	

### Check point 1. Check connection of connector

- Check if connector is loose or removed.
- Check erroneous connection.
- Check if thermistor cable is open

-> Reset power when reinstalling due to removed connector or incorrect wiring.



### Check point 2. Remove connector and check thermistor resistance value

- For the room thermistor resistance value, refer to "[Thermistor resistance values](#)" on page 03-53.
- If thermistor is either open or shorted, replace it and reset the power.

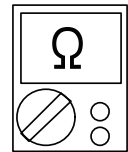

### Check point 3. Check voltage of main PCB

Make sure circuit diagram of each indoor unit and check terminal voltage at thermistor (DC 5.0 V).

**NOTE:** For details of thermistor connector, refer to "[Wiring diagrams](#)" in Chapter 2. TECHNICAL DATA AND PARTS LIST on page 02-14.

If the voltage does not appear, replace main PCB.

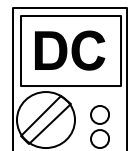

**End**

## 2-8. E: 42. Indoor unit heat exchanger sensor error (Indoor unit)

Indicator	Indoor unit	Operation indicator	4 time flash
		Timer indicator	2 time flash
		Economy indicator	Continuous flash
		Error code	E: 42
	outdoor unit	Refer to " <a href="#">Error code table (Outdoor unit: for 36 model only)</a> " on page 03-3	
Detective actuator	Indoor unit main PCB	When heat exchanger temperature thermistor open or short circuit is detected.	
	Heat exchanger temperature thermistor		
Forecast of cause	Connector connection failure		
	Thermistor failure		
	Main PCB failure		

### Check point 1. Check connection of connector

- Check if connector is loose or removed.
- Check erroneous connection.
- Check if thermistor cable is open

-> Reset power when reinstalling due to removed connector or incorrect wiring.



### Check point 2. Remove connector and check thermistor resistance value

- For the heat exchanger thermistor resistance value, refer to "[Thermistor resistance values](#)" on page 03-53.
- If thermistor is either open or shorted, replace it and reset the power.

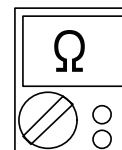

### Check point 3. Check voltage of main PCB

Make sure circuit diagram of each indoor unit and check terminal voltage at thermistor (DC 5.0 V).

**NOTE:** For details of thermistor connector, refer to "[Wiring diagrams](#)" in Chapter 2. TECHNICAL DATA AND PARTS LIST on page 02-14.

If the voltage does not appear, replace main PCB.



**End**

## 2-9. E: 51. Indoor unit fan motor error (Indoor unit)

Indicator	Indoor unit	Operation indicator	5 time flash
		Timer indicator	1 time flash
		Economy indicator	Continuous flash
		Error code	E: 51
	outdoor unit	Refer to " <a href="#">Error code table (Outdoor unit: for 36 model only)</a> " on page 03-3	
Detective actuator	Indoor unit	main PCB	When the condition that actual frequency of indoor fan is below 1/3 of target frequency is continued more than 56 seconds.
		Fan motor	
Forecast of cause			Fan rotation failure
			Fan motor winding open
			Motor protection by surrounding temperature rise
			Control PCB failure
			Indoor unit fan motor failure

### Check point 1. Check rotation of fan

Rotate the fan by hand when operation is off. (Check if fan is caught, dropped off or locked motor)  
→ If fan or bearing is abnormal, replace it.



### Check point 2. Check ambient temperature around motor

Check excessively high temperature around the motor. (If there is any surrounding equipment that causes heat)  
→ Upon the temperature coming down, restart operation.



### Check point 3. Check indoor unit fan motor

Check Indoor unit fan motor. (Refer to indoor unit fan motor in "[Service parts information](#)" on page 03-45.)  
→ If Indoor unit fan motor is abnormal, replace Indoor unit fan motor.



### Check point 4. Replace main PCB

If Check Point 1 to 3 do not improve the symptom, replace main PCB.



**End**

## 2-10. E: 62. Outdoor unit main PCB error (Outdoor unit)

Indicator	Indoor unit	Operation indicator	6 time flash
		Timer indicator	2 time flash
		Economy indicator	Continuous flash
		Error code	E: 62
	outdoor unit	Refer to " <a href="#">Error code table (Outdoor unit: for 36 model only)</a> " on page 03-3	
Detective actuator	Outdoor unit	Main PCB	Access to EEPROM failed due to some cause after outdoor unit started.
Forecast of cause			External cause (Noise, temporary open, voltage drop)
			Main PCB failure

Check point 1. Reset power supply and operate

Does error indication show again?

If no, go to "[Check point 1-2](#)".



Check point 2. Replace main PCB

Change main PCB.



**End**

Check point 1-2. Check external cause

- Check if temporary voltage drop was not generated.
- Check if momentary open was not generated.
- Check if ground is connection correctly or there are no related cables near the power line.



**End**

## 2-11. E: 63. Inverter error (Outdoor unit)

Indicator	Indoor unit	Operation indicator	6 time flash
		Timer indicator	3 time flash
		Economy indicator	Continuous flash
		Error code	E: 63
	outdoor unit	Refer to " <a href="#">Error code table (Outdoor unit: for 36 model only)</a> " on page 03-3	
Detective actuator	Outdoor unit	Inverter PCB	Error information received from inverter PCB
Forecast of cause			External cause
			Power supply to inverter PCB wiring disconnection or open
			Inverter PCB failure

Check point 1. Turn the power on again?

Error displayed again?

If no, go to "[Check point 1-2](#)".



Check point 2. Check the wiring (power supply to inverter PCB)

- Connector and wiring connection state check
- Cable open check



Check point 3. Replace inverter PCB

Replace inverter PCB



**End**

Check point 1-2. Check external cause

- Check if temporary voltage drop was not generated.
- Check if momentary open was not generated.
- Check if ground is connection correctly or there are no related cables near the power line.



**End**

## 2-12. E: 64. PFC circuit error (Outdoor unit)

Indicator	Indoor unit	Operation indicator	6 time flash
		Timer indicator	4 time flash
		Economy indicator	Continuous flash
		Error code	E: 64
	outdoor unit	Refer to " <a href="#">Error code table (Outdoor unit: for 36 model only)</a> " on page 03-3	
Detective actuator	Outdoor unit	Main PCB	<ul style="list-style-type: none"> <li>When inverter input DC voltage is higher than 420 V for over 3 seconds, the compressor stops.</li> <li>If the same operation is repeated 5 times, the compressor stops permanently.</li> </ul>
Forecast of cause			External cause
			Connector connection failure
			Main PCB failure

### Check point 1. Check external cause at indoor and outdoor (Voltage drop or Noise)

- Instant drop: Check if there is a large load electric apparatus in the same circuit.
- Momentary power failure: Check if there is a defective contact or leak current in the power supply circuit.
- Noise: Check if there is any equipment causing harmonic wave near electric line. (Neon bulb or electric equipment that may cause harmonic wave)  
Check the complete insulation of grounding.



### Check point 2. Check connection of Connector

- Check if connector is removed.
- Check erroneous connection.
- Check if cable is open.

→ Upon correcting the removed connector or mis-wiring, reset the power.



### Check point 3. Replace main PCB

If check point 1 to 2 do not improve the symptom, change main PCB.



**End**

## 2-13. E: 65. Trip terminal L error (Outdoor unit)

Indicator	Indoor unit	Operation indicator	6 time flash
		Timer indicator	5 time flash
		Economy indicator	Continuous flash
		Error code	E: 65
	outdoor unit	Refer to " <a href="#">Error code table (Outdoor unit: for 36 model only)</a> " on page 03-3	
Detective actuator	Outdoor unit	Main PCB	When the signal from FO terminal of IPM is "L" (0 V) during the compressor stopping.
Forecast of cause			Main PCB failure

Check point 1. Check main PCB

Replace the outdoor unit main PCB.



**End**

## 2-14. E: 71. Discharge thermistor error (Outdoor unit)

Indicator	Indoor unit	Operation indicator	7 time flash
		Timer indicator	1 time flash
		Economy indicator	Continuous flash
		Error code	E: 71
	outdoor unit	Refer to " <a href="#">Error code table (Outdoor unit: for 36 model only)</a> " on page 03-3	
Detective actuator	Outdoor unit main PCB	When discharge pipe temperature thermistor open or short circuit is detected at power on or while running the compressor	
	Discharge pipe temperature thermistor		
Forecast of cause			Connector failure
			Thermistor failure
			Main PCB failure

### Check point 1. Check connection of connector

- Check if connector is loose or removed.
- Check erroneous connection.
- Check if thermistor cable is open

→ Reset power when reinstalling due to removed connector or incorrect wiring.



### Check point 2. Remove connector and check thermistor resistance value

- For the discharge temperature thermistor resistance value, refer to "[Thermistor resistance values](#)" on page 03-53.
- If thermistor is either open or shorted, replace it and reset the power.

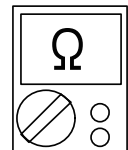

### Check point 3. Check voltage of main PCB

Make sure circuit diagram of outdoor unit and check terminal voltage at thermistor (DC 5.0 V).

**NOTE:** For details of thermistor connector, refer to "[Wiring diagrams](#)" in Chapter 2. TECHNICAL DATA AND PARTS LIST on page 02-14.

If the voltage does not appear, replace main PCB.



**End**



## 2-15. E: 73. Heat exchanger (Middle/Outlet) temperature thermistor error (Outdoor unit)

Indicator	Indoor unit	Operation indicator	7 time flash
		Timer indicator	3 time flash
		Economy indicator	Continuous flash
		Error code	E: 73
	outdoor unit	Refer to " <a href="#">Error code table (Outdoor unit: for 36 model only)</a> " on page 03-3	
Detective actuator	Heat exchanger liquid temperature thermistor	• Heat exchanger liquid temperature thermistor short or open detected	
	Heat exchanger middle temperature thermistor	• Heat exchanger middle temperature thermistor short or open detected	
Forecast of cause		Connector failure	
		Thermistor failure	
		Main PCB failure	

Check Point 1 : Check the connector connection and cable open

- Connector connection state check
- Cable open check



Check Point 2 : Check the thermistor

- For the outdoor unit heat exchanger thermistor resistance value, refer to "[Thermistor resistance values](#)" on page 03-53.
- If thermistor is either open or shorted, replace it and reset the power.

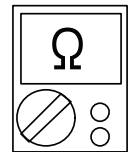

Check point 3. Check voltage of main PCB

Make sure circuit diagram of outdoor unit and check terminal voltage at thermistor (DC 5.0 V).

**NOTE:** For details of thermistor connector, refer to "[Wiring diagrams](#)" in Chapter 2. TECHNICAL DATA AND PARTS LIST on page 02-14.

If the voltage does not appear, replace main PCB.



End

## 2-16. E: 74. Outdoor temperature thermistor error (Outdoor unit)

Indicator	Indoor unit	Operation indicator	7 time flash
		Timer indicator	4 time flash
		Economy indicator	Continuous flash
		Error code	E: 74
	outdoor unit	Refer to " <a href="#">Error code table (Outdoor unit: for 36 model only)</a> " on page 03-3	
Detective actuator	Outdoor unit main PCB	When outdoor temperature thermistor open or short circuit is detected at power on or while running the compressor	
	Outdoor temperature thermistor		
Forecast of cause			Connector failure
			Thermistor failure
			Main PCB failure

### Check point 1. Check connection of connector

- Check if connector is loose or removed.
- Check erroneous connection.
- Check if thermistor cable is open

-> Reset power when reinstalling due to removed connector or incorrect wiring.



### Check point 2. Remove connector and check thermistor resistance value

- For the outdoor temperature thermistor resistance value, refer to "[Thermistor resistance values](#)" on page 03-53.
- If thermistor is either open or shorted, replace it and reset the power.

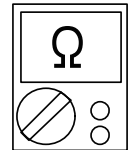

### Check point 3. Check voltage of main PCB

Make sure circuit diagram of outdoor unit and check terminal voltage at thermistor (DC 5.0 V).

**NOTE:** For details of thermistor connector, refer to "[Wiring diagrams](#)" in Chapter 2. TECHNICAL DATA AND PARTS LIST on page 02-14.

If the voltage does not appear, replace main PCB.



**End**

## 2-17. E: 77. Heat sink thermistor error (Outdoor unit)

Indicator	Indoor unit	Operation indicator	7 time flash
		Timer indicator	7 time flash
		Economy indicator	Continuous flash
		Error code	E: 77
	outdoor unit	Refer to " <a href="#">Error code table (Outdoor unit: for 36 model only)</a> " on page 03-3	
Detective actuator	Heat sink temperature thermistor	Heat sink temperature thermistor short or open detected	
Forecast of cause		Connector failure	
		Thermistor failure	
		Inverter PCB failure	

### Check point 1. Check connection of connector

- Check if connector is loose or removed.
- Check erroneous connection.
- Check if thermistor cable is open

-> Reset power when reinstalling due to removed connector or incorrect wiring.



### Check point 2. Remove connector and check thermistor resistance value

- For the Heat sink thermistor resistance value, refer to "[Thermistor resistance values](#)" on page 03-53.
- If thermistor is either open or shorted, replace it and reset the power.

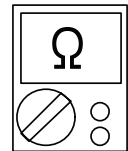

### Check point 3. Check voltage of inverter PCB

Make sure circuit diagram of outdoor unit and check terminal voltage at thermistor (DC 5.0 V).

**NOTE:** For details of thermistor connector, refer to "[Wiring diagrams](#)" in Chapter 2. TECHNICAL DATA AND PARTS LIST on page 02-14.

If the voltage does not appear, replace inverter PCB.

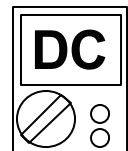

**End**

## 2-18. E: 84. Current sensor error (Outdoor unit)

Indicator	Indoor unit	Operation indicator	8 time flash
		Timer indicator	4 time flash
		Economy indicator	Continuous flash
		Error code	E: 84
	outdoor unit	Refer to " <a href="#">Error code table (Outdoor unit: for 36 model only)</a> " on page 03-3	
Detective actuator	Outdoor unit	main PCB	When input current sensor has detected 0 A, while inverter compressor is operating at higher than 56 rps, after 1 minute upon starting the compressor. (Except during the defrost operation)
Forecast of cause			Defective connection of electric components
			External cause
			Main PCB failure

Check point 1. Reset power supply and operate

Does error indication show again?

If no, go to "[Check point 1-2](#)".



Check point 2. Check connections of outdoor unit electrical components

- Check if the terminal connection is loose.
- Check if connector is removed.
- Check erroneous connection.
- Check if cable is open.

Upon correcting the removed connector or miswiring, reset the power.



Check point 3. Replace main PCB

If Check point 1, 2 do not improve the symptom, change main PCB.



**End**

Check point 1-2. Check external cause at Indoor and Outdoor (Voltage drop or Noise)

- Instant drop: Check if there is a large load electric apparatus in the same circuit.
- Momentary power failure: Check if there is a defective contact or leak current in the power supply circuit.
- Noise: Check if there is any equipment causing harmonic wave near electric line. (Neon bulb or electric equipment that may cause harmonic wave)  
Check the complete insulation of grounding.



**End**

## 2-19. E: 86. High pressure switch error (Outdoor unit)

Indicator	Indoor unit	Operation indicator	8 time flash
		Timer indicator	6 time flash
		Economy indicator	Continuous flash
		Error code	E: 86
	outdoor unit	Refer to " <a href="#">Error code table (Outdoor unit: for 36 model only)</a> " on page 03-3	
Detective actuator	Outdoor unit main PCB	When pressure switch open is detected in 10 seconds after the power is turned on.	
	High pressure switch		
Forecast of cause	High pressure switch connector disconnection or open		
	High pressure switch characteristics failure		
	Main PCB failure		

### Check point 1. Check the high pressure switch connection state

- Check connector and wiring connection state.
- Check if cable is open

-> Reset power when reinstalling due to removed connector or incorrect wiring.



### Check point 2. Check the high pressure switch characteristics

- Check switch characteristics.  
For the characteristics of the high pressure switch, refer to below.



### Check point 3. Replace main PCB

Change main PCB and check operation again.



### End

- Type of contact

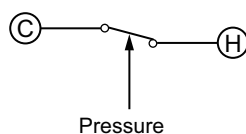

- Characteristics of pressure switch

Pressure switch 1	
Contact: Short → Open	4.2 ±0.1 MPa
Contact: Open → Short	3.2 ±0.15 MPa

30/36 model: P770

## 2-20. E: 86. High pressure switch error (Outdoor unit)(For 36 model)

Indicator	Indoor unit	Operation indicator	8 time flash
		Timer indicator	6 time flash
		Economy indicator	Continuous flash
		Error code	E: 86
	outdoor unit	Refer to " <a href="#">Error code table (Outdoor unit: for 36 model only)</a> " on page 03-3	
Detective actuator	Outdoor unit main PCB	30 seconds or more after power-on, when pressure sensor detection value detects the condition below continuously for 30 seconds or more. $P_s \leq 0$ or $P_s \geq 5$ [MPa]	
	High pressure switch		
Forecast of cause			Connector connection failure
			Pressure sensor failure
			Main PCB failure

### Check point 1. Check connection of the pressure sensor

- Check if the terminal connection is loose.
- Check if connector is removed.
- Check erroneous connection.
- Check if cable is open.

-> Upon correcting the removed connector or mis-wiring, reset the power.



### Check point 2. Check output voltage of main PCB

Make sure circuit diagram of outdoor unit and check terminal voltage at thermistor (DC 5.0 V  $\pm$  5%).

**NOTE:** For details of thermistor connector, refer to "[Wiring diagrams](#)" in Chapter 2. TECHNICAL DATA AND PARTS LIST on page 02-14.

If the voltage is not correct, replace main PCB.



### Check point 3. Check output voltage of pressure sensor

Make sure circuit diagram of outdoor unit and check terminal voltage. Voltage is refer to the following graph.

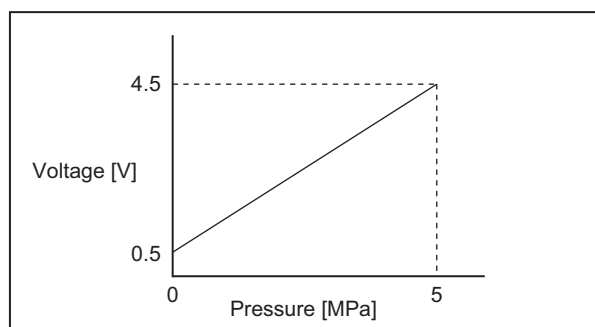

If the voltage is not correct, replace pressure sensor.



**End**

## 2-21. E: 94. Trip detection (Outdoor unit)

Indicator	Indoor unit	Operation indicator	9 time flash
		Timer indicator	4 time flash
		Economy indicator	Continuous flash
		Error code	E: 94
	outdoor unit	Refer to " <a href="#">Error code table (Outdoor unit: for 36 model only)</a> " on page 03-3	
Detective actuator	Outdoor unit	Inverter PCB	Protection stop by over-current generation after inverter compressor start processing completed generated consecutively 10 times. <b>NOTE:</b> The number of generations is reset when the compressor starts up.
		Main PCB	
		Compressor	
Forecast of cause			Outdoor unit fan operation defective, foreign matter on heat-exchanger, excessive rise of ambient temperature
			Main PCB failure
			Inverter compressor failure (lock, winding short)
			Inverter PCB

Check point 1. Check the outdoor unit fan operation, heat-exchanger, ambient temperature

- No obstructions in air passages?
- Heat exchange fins clogged
- Outdoor unit fan motor check
- Ambient temperature not raised by the effect of other heat sources?
- Discharged air not sucked in?



Check point 2. Replace inverter PCB

If Check point 1 do not improve the symptom, change inverter PCB.



Check point 3. Replace main PCB

If Check point 1, 2 do not improve the symptom, change main PCB.



Check point 4. Replace compressor

If Check point 3 do not improve the symptom, change compressor.



**End**

## 2-22. E: 95. Compressor motor control error (Outdoor unit)

Indicator	Indoor unit	Operation indicator	9 time flash
		Timer indicator	5 time flash
		Economy indicator	Continuous flash
		Error code	E: 95
	outdoor unit	Refer to " <a href="#">Error code table (Outdoor unit: for 36 model only)</a> " on page 03-3	
Detective actuator	Outdoor unit	Inverter PCB	<ol style="list-style-type: none"> <li>When running the compressor, if the detected rotor location is out of phase with actual rotor location more than 105°, the compressor stops.</li> <li>After the compressor restarts, if the same operation is repeated within 40 seconds, the compressor stops again.</li> <li>If 1. and 2. repeats 5 times, the compressor stops permanently.</li> </ol>
		Main PCB	
		Compressor	
Forecast of cause		Defective connection of electric components Inverter PCB failure Main PCB failure Compressor failure	

### Check point 1. Check noise from compressor

Turn on power and check operation noise.  
 → If an abnormal noise show, replace compressor.



### Check point 2. Check connection of around the compressor components

For compressor terminal, main PCB

- Check if connector is removed.
- Check erroneous connection.
- Check if cable is open. (Refer to inverter compressor in "[Service parts information](#)" on page 03-45.)

→ Upon correcting the removed connector or mis-wiring, reset the power.



### Check point 3. Replace inverter PCB

If Check point 1, 2 do not improve the symptom, change inverter PCB.



### Check point 4. Replace main PCB

If Check point 1 to 3 do not improve the symptom, change main PCB.



### Check point 5. Replace compressor

If Check point 4 do not improve the symptom, change compressor.



**End**



## 2-23. E: 97. Outdoor unit fan motor error (Outdoor unit)

Indicator	Indoor unit	Operation indicator	9 time flash
		Timer indicator	7 time flash
		Economy indicator	Continuous flash
		Error code	E: 97
	outdoor unit	Refer to " <a href="#">Error code table (Outdoor unit: for 36 model only)</a> " on page 03-3	
Detective actuator	Outdoor unit	Inverter PCB	<ol style="list-style-type: none"> <li>When outdoor fan rotation speed is less than 100 rpm in 20 seconds after fan motor starts, fan motor stops.</li> <li>After fan motor restarts, if the same operation within 60 seconds is repeated 3 times in a row, compressor and fan motor stops.</li> <li>If 1. and 2. repeats 5 times in a row, compressor and fan motor stops permanently.</li> </ol>
		Main PCB	
		Fan motor	
Forecast of cause			Fan rotation failure
			Motor protection by surrounding temperature rise
			Inverter PCB failure
			Main PCB failure
		Outdoor unit fan motor	

### Check point 1. Check rotation of fan

Rotate the fan by hand when operation is off. (Check if fan is caught, dropped off or locked motor)  
→ If fan or bearing is abnormal, replace it.



### Check point 2. Check ambient temperature around motor

Check excessively high temperature around the motor. (If there is any surrounding equipment that causes heat)  
→ Upon the temperature coming down, restart operation.



### Check point 3. Check outdoor unit fan motor

Check outdoor unit fan motor. (Refer to outdoor unit fan motor in "[Service parts information](#)" on page 03-45.)  
→ If outdoor unit fan motor is abnormal, replace outdoor unit fan motor and main PCB.



## Check point 4. Check output voltage of inverter PCB

Check outdoor unit circuit diagram and the voltage. (Measure at inverter PCB side connector)

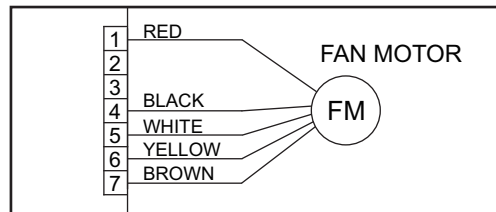

**NOTE:** For details of wiring diagram, refer to "[Wiring diagrams](#)" in Chapter 2. TECHNICAL DATA AND PARTS LIST on page 02-14.

Read wire	DC voltage
Red—Black	280 V (AC 220 V -10%) to 373 V (AC 240 V +10%)
White—Black	15 ± 1.5 V

-> If the voltage is not correct, replace inverter PCB.



## Check point 5. Replace main PCB

If Check point 1 to 4 do not improve the symptom, change main PCB.



**End**

## 2-24. E: 99. 4-way valve error (Outdoor unit)

Indicator	Indoor unit	Operation indicator	9 time flash
		Timer indicator	9 time flash
		Economy indicator	Continuous flash
		Error code	E: 99
	outdoor unit	Refer to " <a href="#">Error code table (Outdoor unit: for 36 model only)</a> " on page 03-3	
Detective actuator	Indoor unit	main PCB	When the indoor heat exchanger temperature is compared with the room temperature, and either following condition is detected continuously two times, the compressor stops. Indoor heat exchanger temp. - Room temp. > 10 °C (Cooling or Dry operation) Indoor heat exchanger temp. - Room temp. < -10 °C (Heating operation) If the same operation is repeated 5 times, the compressor stops permanently.
	Heat exchanger temperature thermistor		
	Room temperature thermistor		
	4-way valve		
Forecast of cause			Air filter clogged
			Connector connection failure
			Thermistor failure
			Coil failure
			4-way valve failure
		Main PCB failure	

### Check point 1. Check air filter condition

Check air filter dirty.

→ If the air filter dirty, clean up the air filter.



### Check point 2. Check connection of connector

- Check if connector is removed.
- Check erroneous connection.
- Check if thermistor cable is open.

→ Upon correcting the removed connector or mis-wiring, reset the power.



### Check point 3. Check each thermistor

- Isn't it fallen off the holder?
- Is there a cable pinched?

Check characteristics of room thermistor and indoor unit heat exchanger thermistor.

For the thermistor resistance value, refer to "[Thermistor resistance values](#)" on page 03-53.

→ If defective, replace the thermistor.



**Check point 4. Check the solenoid coil and 4-way valve**

**NOTE:** Refer solenoid coil and 4-way valve in "[Service parts information](#)" on page 03-45.

- **Solenoid coil**  
Remove from PCB and check the resistance value of coil. Resistance value is 1.97 kΩ.  
→ If it is open or abnormal resistance value, replace solenoid coil.
- **4-way valve**  
Check each piping temperature, and the location of the valve by the temperature difference.  
If the value location is not proper, replace 4-way valve.

**Check point 5. Replace main PCB**

If Check Point 1 to 4 do not improve the symptom, replace main PCB.



**End**

## 2-25. E: A1. Discharge temperature error (Outdoor unit)

Indicator	Indoor unit	Operation indicator	10 time flash
		Timer indicator	1 time flash
		Economy indicator	Continuous flash
		Error code	E: A1
	outdoor unit	Refer to " <a href="#">Error code table (Outdoor unit: for 36 model only)</a> " on page 03-3	
Detective actuator	Outdoor unit main PCB	Protection stop by discharge temperature $\geq 110$ °C during compressor operation generated 2 times within 24 hours.	
	Discharge temperature thermistor		
Forecast of cause			3-way valve not opened
			EEV defective, strainer clogged
			Outdoor unit operation failure, foreign matter on heat exchanger
			Discharge temperature thermistor failure
			Insufficient refrigerant
			Main PCB failure

Check point 1. Check if 3-way valve is open

If the 3-way valve is closed, open the 3-way valve and check operation.

**NOTE:** For cooling operation, check gas side of the 3-way valve.

For heating operation, check liquid side of the 3-way valve.



Check point 2. Check the electronic expansion valve (EEV) and strainer

- Check if EEV open.  
Refer to outdoor unit Electronic Expansion Valve (EEV) in "[Service parts information](#)" on page 03-45.
- Check the strainer clogging.



Check point 3. Check the outdoor unit fan and heat exchanger

- Check for foreign object at heat exchanger
- Check if fan can be rotated by hand.
- Check the motor. (Refer to outdoor unit fan motor in "[Service parts information](#)" on page 03-45.)



Check point 4. Check the discharge thermistor

The discharge temperature thermistor characteristics check. (Check by disconnecting thermistor from PCB.)

**NOTE:** For the characteristics of the thermistor, refer to "[Thermistor resistance values](#)" on page 03-53.



Check point 5. Check the refrigerant amount

Check the refrigerant leakage.



Check point 6. Replace main PCB

If check point 1 to 5 do not improve the symptom, replace the main PCB.



**End**

## 2-26. E: A5. Low pressure error (Outdoor unit)

Indicator	Indoor unit	Operation indicator	10 time flash
		Timer indicator	5 time flash
		Economy indicator	Continuous flash
		Error code	E: A5
	outdoor unit	Refer to " <a href="#">Error code table (Outdoor unit: for 36 model only)</a> " on page 03-3	
Detective actuator	Outdoor unit main PCB	Protection stop by suction pressure $\geq 0.02$ MPaG continued 5 minutes repeats 5 times within 24 hours.	
	Suction pressure sensor		
Forecast of cause			3-way valve not opened
			Outdoor unit ambient temperature too low
			Outdoor unit operation failure, foreign matter on heat exchanger
			EEV defective, strainer clogged
			Solenoid valve defective
			Low pressure sensor characteristics defective
			Insufficient refrigerant
			Main PCB failure

Check point 1. Check if 3-way valve is open

If the 3-way valve is closed, open the 3-way valve and check operation.

**NOTE:** For cooling operation, check gas side of the 3-way valve.  
For heating operation, check liquid side of the 3-way valve.



Check point 2. Check the outdoor unit ambient temperature (Only when heating operation)

Outdoor unit ambient temperature lower than operating range?



Check point 3. Check the outdoor unit fan and heat exchanger (Only when heating operation)

- No foreign object in air passage?
- Heat exchanger fins clogged?
- Fan rotates?
- Check the motor. (Refer to outdoor unit fan motor in "[Service parts information](#)" on page 03-45.)



Check point 4. Check the electronic expansion valve (EEV) and strainer

- Check if EEV open.  
Refer to outdoor unit Electronic Expansion Valve (EEV) in "[Service parts information](#)" on page 03-45.
- Check the strainer clogging.



Check point 5. Check the suction pressure sensor

Check the suction pressure sensor characteristics.

**NOTE:** For the characteristics of the thermistor, refer to suction pressure sensor in "[Service parts information](#)" on page 03-45.



Check point 6. Check the refrigerant amount

Check the refrigerant leakage.



Check point 7. Replace main PCB

If check point 1 to 6 do not improve the symptom, replace the main PCB.



**End**



## 2-27. E: AC. Heat sink temperature error (Outdoor unit)

Indicator	Indoor unit	Operation indicator	10 time flash
		Timer indicator	12 time flash
		Economy indicator	Continuous flash
		Error code	E: AC
	outdoor unit	Refer to " <a href="#">Error code table (Outdoor unit: for 36 model only)</a> " on page 03-3	
Detective actuator	Outdoor unit inverter PCB	Protection stop by heat sink temperature $\geq 80$ °C during heat sink operation generated 2 times within 24 hours.	
	Heat sink temperature thermistor		
Forecast of cause	Foreign matter on heat sink, heat sink dirty		
	Foreign matter on heat exchanger, excessive ambient temperature rise		
	Heat sink temp. thermistor defective		

Check point 1. Check the heat sink state

Heat sink foreign matter, soiling check



Check point 2. Check the foreign matter and ambient temperature of heat exchanger

- Heat exchange foreign matter check
- Ambient temperature not raised by effect of other heat sources?
- Discharged air not sucked in?



Check point 3. Check the heat sink temperature thermistor

The heat sink temperature thermistor characteristics check. (Check by disconnecting thermistor from PCB.)

**NOTE:** For the characteristics of the thermistor, refer to "[Thermistor resistance values](#)" on page 03-53.



Check point 4. Replace inverter PCB

Replace inverter PCB



**End**

## 3. Troubleshooting without error code

### 3-1. Indoor unit—No power

Forecast of cause	Power supply failure
	External cause
	Electrical components defective

#### Check point 1. Check installation condition

- Isn't the breaker down?
- Check loose or removed connection cable.

-> If abnormal condition is found, correct it by referring to the installation manual or the "DESIGN & TECHNICAL MANUAL".



#### Check point 2. Check external cause at indoor and outdoor (voltage drop or noise)

- Instant drop: Check if there is a large load electric apparatus in the same circuit.
- Momentary power failure: Check if there is a defective contact or leak current in the power supply circuit.
- Noise: Check if there is any equipment causing harmonic wave near electric line. (Neon bulb or electric equipment that may cause harmonic wave)  
Check the complete insulation of grounding.



#### Check point 3. Check electrical components

Check the voltage of power supply.

Check if AC 198 to 264 V appears at outdoor unit terminal L—N.

-> If no, go to "[Check point 1](#)" and "[Check point 2](#)".



- Check fuse in filter PCB.  
If fuse is open, check if the wiring between terminal and filter PCB is loose, and replace fuse.
- Check varistor in filter PCB.  
If varistor is defective, there is a possibility of an abnormal power supply.  
Check the correct power supply and replace varistor.  
Upon checking the normal power supply, replace varistor.



**End**

## 3-2. Outdoor unit—No power

Forecast of cause	Power supply failure
	External cause
	Electrical components defective

### Check point 1. Check installation condition

- Is the circuit breaker on or off?
- Check loose or removed connection cable.

→ If abnormal condition is found, correct it by referring to the installation manual or the "DESIGN & TECHNICAL MANUAL".



### Check point 2. Check external cause at indoor and outdoor (voltage drop or noise)

- Instant drop: Check if there is a large load electric apparatus in the same circuit.
- Momentary power failure: Check if there is a defective contact or leak current in the power supply circuit.
- Noise: Check if there is any equipment causing harmonic wave near electric line. (Neon bulb or electric equipment that may cause harmonic wave)  
Check the complete insulation of grounding.



### Check point 3. Check electrical components

Check the voltage of power supply.

Check if AC 198 to 264 V appears at outdoor unit terminal L - N

→ If no, go to "[Check point 1](#)" and "[Check point 2](#)".

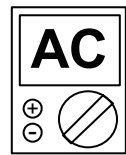

- Check fuse in main PCB.  
If fuse is open, check if the wiring between terminal and main PCB is loose, and replace fuse.



### Check point 4. Replace main PCB

If check point 1 to 3 do not improve the symptom, change main PCB.



**End**

### 3-3. No operation (Power is on)

Forecast of cause	Setting/ Connection failure
	External cause
	Electrical components defective

#### Check point 1. Check indoor and outdoor installation condition

- Indoor unit:
    - Check incorrect wiring between indoor unit and remote controller.
    - Check if there is an open cable connection.
  - Are these indoor unit, outdoor unit, and remote controller suitable model numbers to connect?
- > If there is some abnormal condition, correct it by referring to the installation manual and “DESIGN & TECHNICAL MANUAL”.



Turn off the power and check correct followings.

- Is there loose or removed communication line of indoor unit and outdoor unit?



#### Check point 2. Check external cause at indoor and outdoor (Voltage drop or Noise)

- Instant drop: Check if there is a large load electric apparatus in the same circuit.
- Momentary power failure: Check if there is a defective contact or leak current in the power supply circuit.
- Noise: Check if there is any equipment causing harmonic wave near electric line. (Neon bulb or electric equipment that may cause harmonic wave)  
Check the complete insulation of grounding.



#### Check point 3. Check wired remote controller and controller PCB

Check voltage at CN300 (terminal 1—3) of main PCB.  
(Power supply to remote controller)

- If it is DC 13 V, remote controller is failure. (The controller PCB is normal)  
-> Replace remote controller.
- If it is DC 0 V, controller PCB is failure. (Check the remote controller once again)  
-> Replace controller PCB.



#### Check point 4. Replace main PCB

If check point 1 to 3 do not improve the symptom, change main PCB.



**End**

## 3-4. No cooling/No heating

Forecast of cause	Indoor unit error
	Outdoor unit error
	Effect by surrounding environment
	Connection pipe/Connection wire failure
	Refrigeration cycle failure

### Check point 1. Check Indoor unit

- Does Indoor unit fan run in the HIGH mode?
- Is air filter dirty?
- Is heat exchanger clogged?
- Check if energy save function is operated.



### Check point 2. Check outdoor unit operation

- Check if outdoor unit is operating.
- Check any objects that obstruct the air flow route.
- Check if heat exchanger is clogged.
- Is the valve open?



### Check point 3. Check site condition

- Is capacity of Indoor unit fitted to the room size?
- Any windows open or direct sunlight?



### Check point 4. Check Indoor/ Outdoor installation condition

- Check connection pipe (specified pipe length and pipe diameter?)
- Check any loose or removed communication line.

→ If there is an abnormal condition, correct it by referring to the installation manual or the "DESIGN & TECHNICAL MANUAL".



### Check point 5. Check Refrigeration cycle

- Check if strainer is clogged (Refer to the figure below).
- Measure gas pressure, and if there is a leakage, correct it.
- Check the electronic expansion valve.  
Refer to outdoor unit Electronic Expansion Valve (EEV) in "[Service parts information](#)" on page 03-45.
- Check compressor.  
Refer to compressor in "[Service parts information](#)" on page 03-45.  
Refer to inverter compressor in "[Service parts information](#)" on page 03-45.

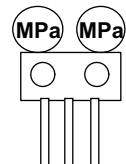

**NOTE:** When recharging the refrigerant, make sure to perform vacuuming, and recharge the specified amount.



**End**

**NOTES:**

- Strainer normally does not have temperature difference between inlet and outlet as shown below.

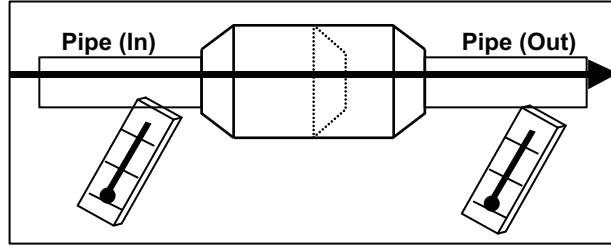

- If there is a difference like shown below, there is a possibility of inside clogged. In this case, replace the strainer.

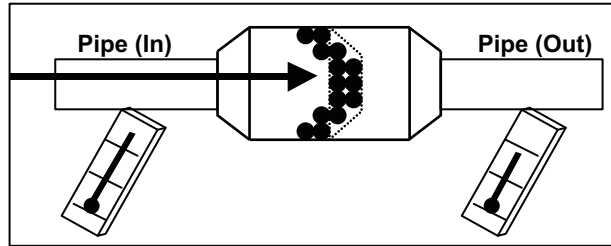

## 3-5. Abnormal noise

Forecast of cause	Abnormal installation (indoor unit/outdoor unit)
	Fan failure (indoor unit/outdoor unit)
	Compressor failure (outdoor)

### Diagnosis method when abnormal noise is occurred

Abnormal noise is coming from Indoor unit.  
(Check and correct followings)



- Is main unit installed in stable condition?
- Is the installation of air suction grille and front panel normal?



- Is fan broken or deformed?
- Is the screw of fan loose?
- Is there any object which obstruct the fan rotation?



**End**

Abnormal noise is coming from Outdoor unit.  
(Check and correct followings)



- Is main unit installed in stable condition?
- Is fan guard installed normally?



- Is fan broken or deformed?
- Is the screw of fan loose?
- Is there any object which obstruct the fan rotation?



Check if vibration noise by loose bolt or contact noise of piping is happening.



Is compressor locked?

- Check Compressor  
Refer to compressor and inverter compressor in "[Service parts information](#)" on page 03-45.



**End**

## 3-6. Water leaking

Forecast of cause	Erroneous installation
	Drain hose failure

### Diagnosis method when water leak occurs

- Is main unit installed in stable condition?
- Is main unit broken or deformed at the time of transportation or maintenance?



- Is drain hose connection loose?
- Is there a trap in drain hose?
- Is drain hose clogged?



Is fan rotating?



**End**

### Diagnosis method when water is spitting out

Is the filter clogged?



Check gas pressure and correct it if there was a gas leak.

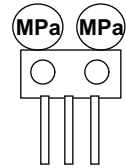

**End**



## 4. Service parts information

### 4-1. Compressor

Diagnosis method of compressor (If outdoor unit LED displays error, refer to troubleshooting)

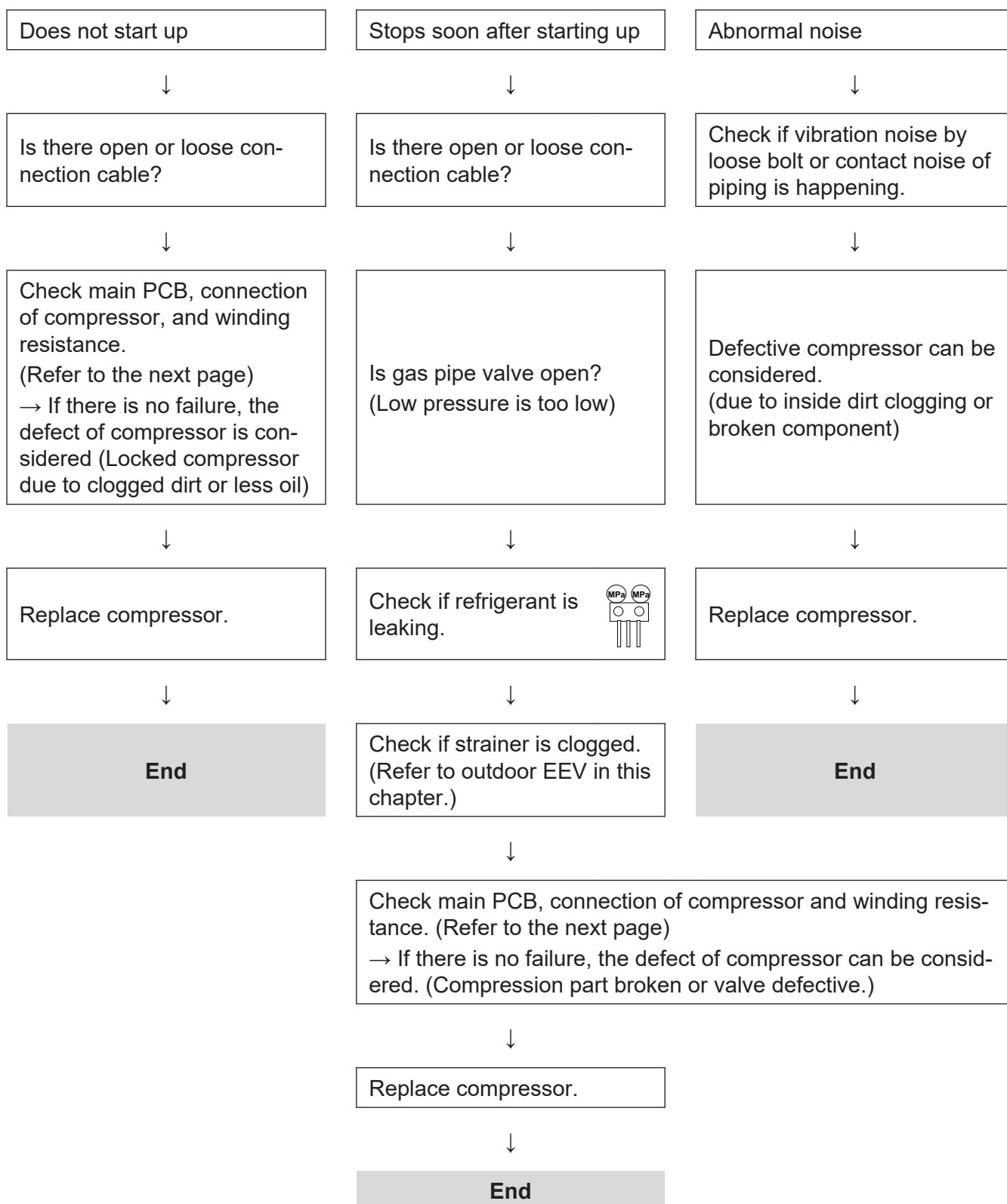

## 4-2. Inverter compressor

### ■ Models: AOYG30KMTA and AOYG36KMTA

#### Check point 1. Check connection

- Check terminal connection of compressor (loose or incorrect wiring)

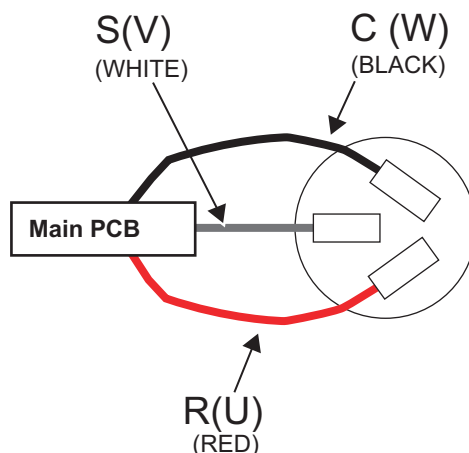

- Check terminal connection of main PCB (loose or incorrect wiring)

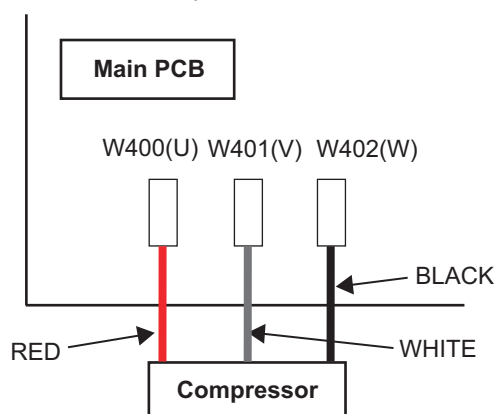

↓

#### Check point 2. Check winding resistance

Check winding resistance of each terminal.

Resistance value:  $1.125 \Omega \pm 7\%$  at  $25^\circ\text{C}$

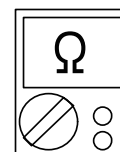
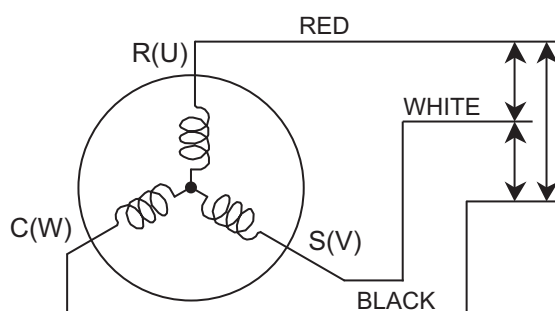

→ If the resistance value is  $0 \Omega$  or infinite, replace compressor.

↓

#### Check point 3. Replace inverter PCB

If check point 1 to 2 do not improve the symptom, replace main PCB.

## 4-3. Outdoor unit Electronic Expansion Valve (EEV)

### ■ Models: AOYG30KMTA and AOYG36KMTA

#### Check point 1. Check connections

Check connection of connector. (Loose connector or open cable)

**NOTE:** For details of wiring diagram, refer to "Wiring diagrams" in Chapter 2. TECHNICAL DATA AND PARTS LIST on page 02-14.

#### Check point 2. Check coil of EEV

Remove connector, check each winding resistance of coil.

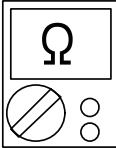
Read wire	Resistance value
1(Red) - 2(Blue)	$46 \Omega \pm 3 \Omega$ at 20°C 
1(Red) - 3(Orange)	
1(Red) - 4(Yellow)	
1(Red) - 5(White)	

→ If Resistance value is abnormal, replace EEV.

#### Check point 3. Check Voltage from main PCB

Remove connector and check voltage (DC 12 V)

→ If it does not appear, replace main PCB.



#### Check point 4. Check noise at start up

Turn on the power and check the operation noise.

→ If an abnormal noise does not show, replace main PCB.

#### Check point 5. Check Opening and Closing Operation of Valve

When valve is closed, it has a temp. difference between inlet and outlet

**CLOSE**  
Example : Hot Gas

Pipe (In)  
Hi TEMP.

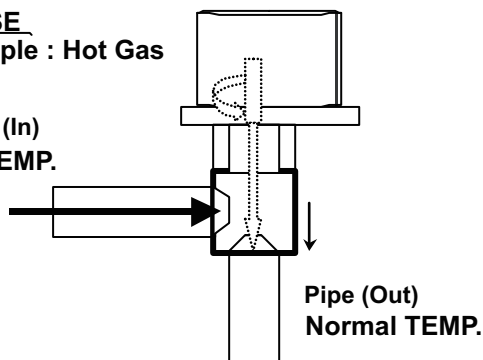

If it is open, it has no temp. difference between inlet and outlet

**OPEN**  
Example : Hot Gas

Pipe (In)  
Hi TEMP.

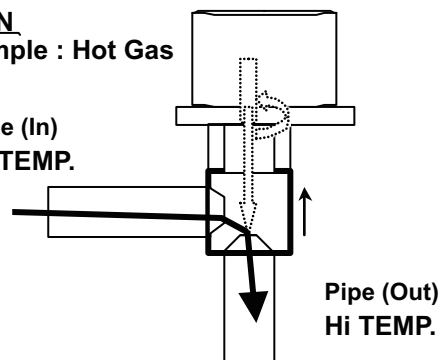

## Check point 6. Check strainer

- Strainer normally does not have temperature difference between inlet and outlet as shown below.

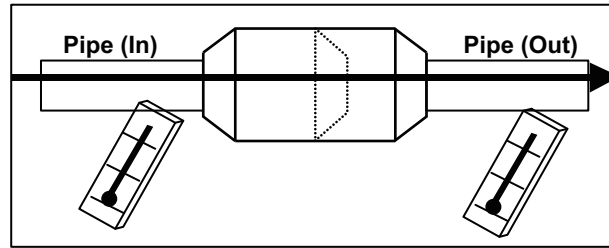

- If there is a difference like shown below, there is a possibility of inside clogged. In this case, replace the strainer.

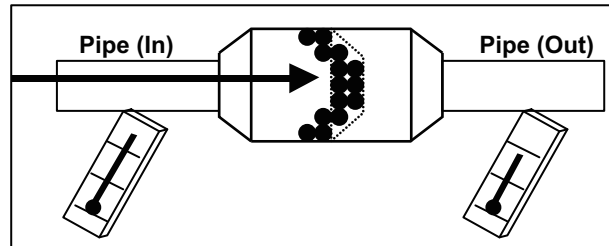

## 4-4. Indoor unit fan motor

### ■ Models: ASYG30KMTA and ASYG36KMTA

#### Check point 1. Check rotation of fan

Rotate the fan by hand when operation is off.  
 (Check if fan is caught, dropped off or locked motor)  
 → If fan or bearing is abnormal, replace it.

#### Check point 2. Check resistance of indoor fan motor

Refer to below. Circuit-test "Vm" and "GND" terminal

**NOTE:** Vm: DC voltage, GND: Earth terminal

→ If they are short-circuited (below 300 kΩ), replace indoor fan motor and controller PCB.

Pin number (wire color)	Terminal function (symbol)
1 (Red)	DC voltage (Vm)
2	No function
3	No function
4 (Black)	Earth terminal (GND)
5 (White)	Control voltage (Vcc)
6 (Yellow)	Speed command (Vsp)
7 (Blue)	Feed back (FG)

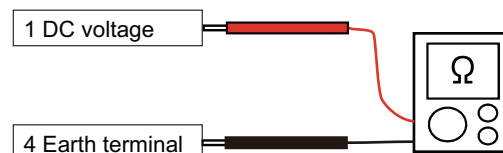

## 4-5. Outdoor unit fan motor

### ■ Models: AOYG30KMTA and AOYG36KMTA

#### Check point 1. Check rotation of fan

Rotate the fan by hand when operation is off.  
 (Check if fan is caught, dropped off or locked motor)  
 → If fan or bearing is abnormal, replace it.

#### Check point 2. Check resistance of outdoor fan motor

Refer to below. Circuit-test "Vm" and "GND" terminal

**NOTE:** Vm: DC voltage, GND: Earth terminal

→ If they are short-circuited (below 300 k $\Omega$ ), replace outdoor fan motor and controller PCB.

Pin number (wire color)	Terminal function (symbol)
1 (Red)	DC voltage (Vm)
2	No function
3	No function
4 (Black)	Earth terminal (GND)
5 (White)	Control voltage (Vcc)
6 (Yellow)	Speed command (Vsp)
7 (Brown)	Feed back (FG)

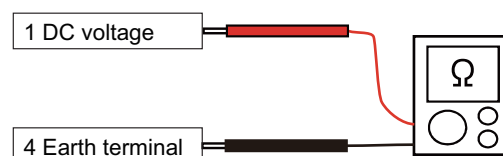

## 4-6. Pressure switch

### ■ Models: AOYG30KMTA and AOYG36KMTA

- Type of contact

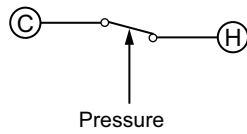

- Characteristics of pressure switch

Pressure switch 1	
Contact: Short → Open	4.2 — 4.05 MPa
Contact: Open → Short	3.2 ± 0.15 MPa

30/36 model: P770

## 4-7. 4-way valve coil (solenoid coil)/4-way valve

### ■ Models: AOYG30KMTA and AOYG36KMTA

#### Check point 1. Check connection

- Check the connection of connector P60.

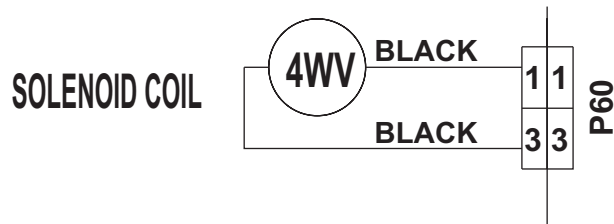

↓

#### Check Point 2 : Check solenoid coil

Remove P60 from PCB and check the resistance value of coil.  
Resistance Value  $\approx 1.97 \text{ k}\Omega$

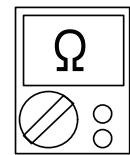
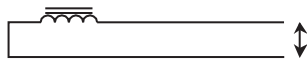

→ If it is Open or abnormal resistance value, replace solenoid coil.

↓

#### Check Point 3: Check operation of 4 way valve

Check each piping temperature, and confirm the location of the valve by the temperature difference

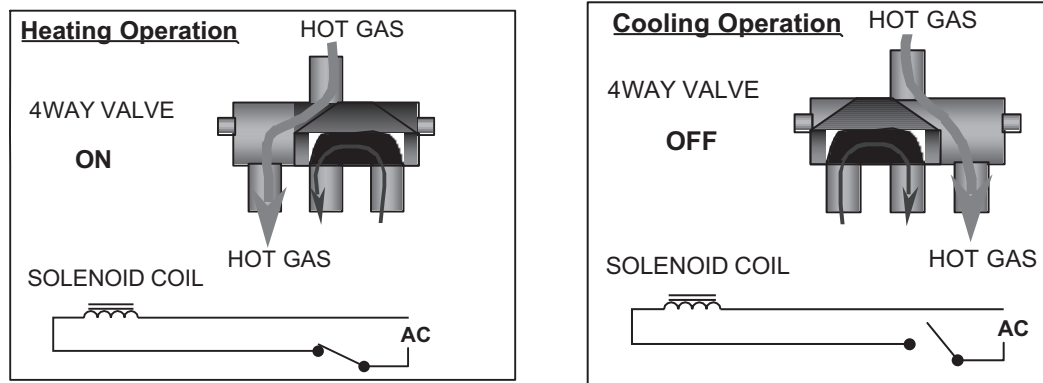

→ If the valve location is not proper, replace 4 way valve.

↓

#### Check Point 4: Replace main PCB

If none of Checks 1 to 3 apply, replace the main PCB.



## 5. Thermistor resistance values

### 5-1. Indoor unit

#### ■ Room temperature thermistor

Temperature (°C)	Resistance (kΩ)	Voltage (V)
-10.0	58.25	0.73
-5.0	44.03	0.93
0.0	33.62	1.15
5.0	25.92	1.39
10.0	20.17	1.66
15.0	15.84	1.94
20.0	12.54	2.22
25.0	10.00	2.50
30.0	8.04	2.77
35.0	6.51	3.03
40.0	5.30	3.27
45.0	4.35	3.48

#### ■ Heat exchanger temperature thermistor

Temperature (°C)	Resistance (kΩ)	Voltage (V)
-30.0	1,131.91	0.21
-25.0	804.52	0.29
-20.0	579.59	0.40
-15.0	422.89	0.53
-10.0	312.27	0.69
-5.0	233.21	0.88
0.0	176.03	1.10
5.0	134.23	1.36
10.0	103.34	1.63
15.0	80.28	1.92
20.0	62.91	2.21
25.0	49.70	2.51
30.0	39.57	2.79
35.0	31.74	3.06
40.0	25.64	3.30
45.0	20.85	3.53
50.0	17.06	3.73
55.0	14.05	3.90
60.0	11.64	4.05
63.0	10.42	4.14

## 5-2. Outdoor unit

### ■ Discharge temperature thermistor

Temperature (°C)	Resistance (kΩ)	Voltage (V)
-30.0	1,013.11	0.06
-25.0	729.09	0.09
-20.0	531.56	0.12
-15.0	392.31	0.16
-10.0	292.91	0.21
-5.0	221.09	0.28
0.0	168.60	0.36
5.0	129.84	0.46
10.0	100.91	0.57
15.0	79.12	0.71
20.0	62.55	0.86
25.0	49.84	1.03
30.0	40.01	1.23
35.0	32.35	1.43
40.0	26.34	1.65
45.0	21.58	1.88
50.0	17.79	2.11
55.0	14.75	2.34
60.0	12.30	2.57
65.0	10.32	2.79
70.0	8.70	3.00
75.0	7.36	3.19
80.0	6.27	3.37
85.0	5.36	3.54
90.0	4.60	3.69
95.0	3.96	3.83
100.0	3.43	3.96
105.0	2.98	4.07
110.0	2.60	4.17
115.0	2.27	4.26
120.0	2.00	4.33

## ■ Heat exchanger temperature thermistor

Temperature (°C)	Resistance (kΩ)	Voltage (V)
-30.0	95.58	0.24
-25.0	68.90	0.32
-20.0	50.30	0.43
-15.0	37.19	0.57
-10.0	27.80	0.73
-5.0	21.01	0.92
0.0	16.05	1.14
5.0	12.38	1.39
10.0	9.63	1.65
15.0	7.56	1.93
20.0	5.98	2.21
25.0	4.77	2.49
30.0	3.84	2.77
35.0	3.10	3.02
40.0	2.53	3.26
45.0	2.08	3.48
50.0	1.71	3.68
55.0	1.42	3.85
60.0	1.19	4.00
65.0	1.00	4.13
70.0	0.84	4.29
75.0	0.71	4.35
80.0	0.61	4.43
85.0	0.52	4.51
90.0	0.45	4.57

## ■ Outdoor temperature thermistor

Temperature (°C)	Resistance (kΩ)	Voltage (V)
-30.0	224.33	0.73
-25.0	159.71	0.97
-20.0	115.24	1.25
-15.0	84.21	1.56
-10.0	62.28	1.90
-5.0	46.58	2.26
0.0	35.20	2.61
5.0	26.88	2.94
10.0	20.72	3.24
15.0	16.12	3.52
20.0	12.64	3.76
25.0	10.00	3.96
30.0	7.97	4.14
35.0	6.40	4.28
40.0	5.18	4.40
45.0	4.21	4.50
50.0	3.45	4.59
55.0	2.84	4.65
60.0	2.36	4.71
65.0	1.97	4.76
70.0	1.65	4.79
75.0	1.39	4.83
80.0	1.17	4.85



## 4. CONTROL AND FUNCTIONS

# CONTENTS

## 4. CONTROL AND FUNCTIONS

<b>1. Compressor frequency control</b> .....	<b>04-1</b>
1-1. Cooling operation .....	04-1
1-2. Heating operation .....	04-2
1-3. Dry operation .....	04-2
1-4. Compressor frequency at normal start-up .....	04-3
1-5. Compressor frequency limitation by outdoor temperature .....	04-4
<b>2. Auto changeover operation</b> .....	<b>04-6</b>
<b>3. Fan control</b> .....	<b>04-8</b>
3-1. Indoor fan control.....	04-8
3-2. Outdoor fan control .....	04-12
<b>4. Louver control</b> .....	<b>04-13</b>
4-1. Vertical airflow direction louver control .....	04-13
4-2. Horizontal airflow direction louver control .....	04-13
4-3. Swing operation.....	04-14
<b>5. Timer operation control</b> .....	<b>04-15</b>
5-1. Wireless remote control .....	04-15
5-2. Wired remote control .....	04-17
<b>6. Defrost operation control</b> .....	<b>04-20</b>
6-1. Defrost operation in heating operation stopped .....	04-21
<b>7. Various control</b> .....	<b>04-22</b>
7-1. Auto restart.....	04-22
7-2. MANUAL AUTO operation.....	04-22
7-3. Forced cooling operation .....	04-23
7-4. 10 °C HEAT operation .....	04-23
7-5. ECONOMY operation .....	04-23
7-6. POWERFUL operation .....	04-24
7-7. Fresh air control.....	04-24
7-8. Compressor preheating .....	04-24
7-9. External electrical heater control .....	04-25
7-10. Electronic expansion valve control .....	04-25
7-11. Prevention to restart for 3 minutes (3 minutes st) .....	04-25
7-12. 4-way valve control .....	04-25
7-13. Human sensor for energy saving.....	04-26
7-14. Peak cut operation .....	04-26
<b>8. Various protections</b> .....	<b>04-27</b>
8-1. Discharge gas temperature over-rise prevention control .....	04-27
8-2. Anti-freezing control (cooling and dry mode) .....	04-27
8-3. Current release control .....	04-28
8-4. Compressor temperature protection .....	04-28
8-5. High pressure protection .....	04-28

## **CONTENTS (continued)**

8-6. Low outdoor temperature protection .....	04-28
8-7. High temperature and high pressure release control .....	04-29





# 1. Compressor frequency control

## 1-1. Cooling operation

A sensor (room temperature thermistor) built in the indoor unit body will usually perceive difference or variation between a set temperature and present room temperature, and controls the operation frequency of the compressor.

- If the room temperature is 6.0 °C higher than a set temperature, the compressor operation frequency will attain to maximum performance.
- If the room temperature is 1.0 °C lower than a set temperature, the compressor will be stopped.
- When the room temperature is within the range of +6.0°C to -1.0°C of the setting temperature, the compressor frequency is controlled within the range shown in the table below. However, the maximum frequency is limited in the range shown in the figure below based on the indoor fan mode and the outdoor temperature.

### • Compressor frequency range

Model name	Minimum frequency	Maximum frequency
ASYG30KMTA ASYG36KMTA	15 rps	110 rps

### • Limit of maximum speed based on outdoor temperature

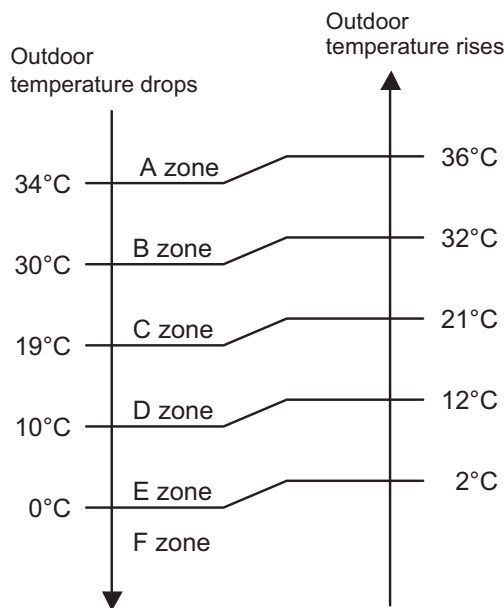

Unit: rps

Model name	Outdoor temperature zone	Indoor unit fan mode			
		HIGH	MED	LOW	QUIET
ASYG30KMTA ASYG36KMTA	A zone	110	72	60	55
	B zone	110	72	60	55
	C zone	100	60	57	55
	D zone	67	55	49	32
	E zone	67	55	49	32
	F zone	67	55	49	32

## 1-2. Heating operation

A sensor (room temperature thermistor) built in indoor unit body will usually perceive difference or variation between setting temperature and present room temperature, and controls operation frequency of compressor.

- If the room temperature is 6.0 °C lower than a set temperature, the compressor operation frequency will attain to maximum performance.
- If the room temperature is 1.0 °C higher than a set temperature, the compressor will be stopped.
- When the room temperature is within the range of +1.0°C to -6.0°C of the setting temperature, the compressor frequency is controlled within the range shown below.

- **Compressor frequency range**

Unit: rps

Model name	Minimum frequency	Maximum frequency
ASYG30KMTA ASYG36KMTA	15	120

## 1-3. Dry operation

The compressor rotation frequency shall change according to the temperature, set temperature, and room temperature variation which the room temperature sensor of the indoor unit has detected as shown in the table below.

Zone is defined by set temperature and room temperature.

- **Compressor frequency range**

Unit: rps

Model name	Outdoor temperature zone	Operating frequency
ASYG30KMTA ASYG36KMTA	X zone	40
	J zone	17
	Y zone	0

- **Compressor control based on room temperature**

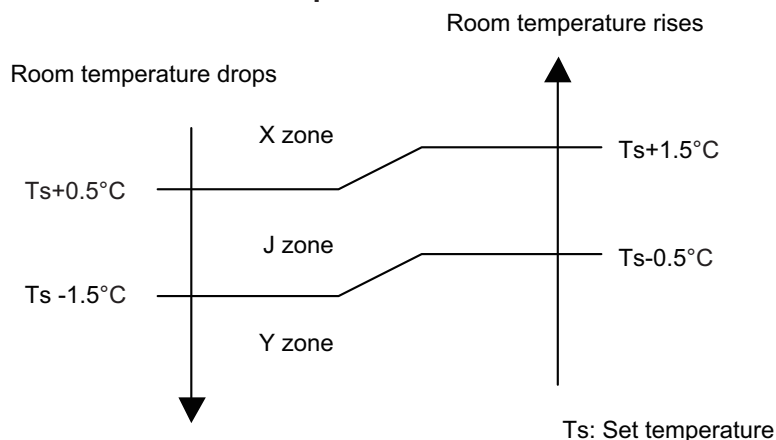

## 1-4. Compressor frequency at normal start-up

### ■ Models: AOYG30KMTA and AOYG36KMTA

Compressor frequency soon after starting is controlled as below.

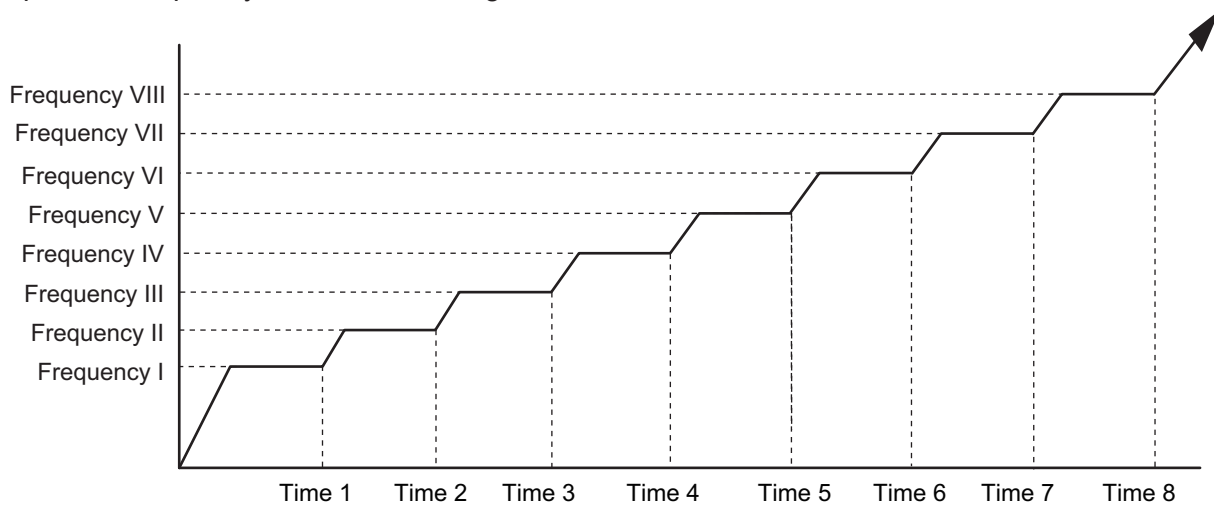

- Normal operation

Frequency (rps)	I 25	II 42	III 53	IV 61	V 65	VI 75	VII 85	VIII 92
Time (sec)	1 90	2 150	3 270	4 330	5 390	6 450	7 570	8 630

- Special operation

Frequency (rps)	I 25	II 42	III 53	IV 61	V 65	VI 75	VII 85	VIII 92
Time (sec)	1 225	2 305	3 605	4 665	5 725	6 785	7 855	8 1,000

#### NOTES:

- Normal operation:
  - Cooling and dry mode
    - Below 3 hours from the compressor stop and the compressor thermistor  $\geq 15\text{ }^{\circ}\text{C}$
    - After defrost operation
  - Other than when the compressor starts for the first time since the breaker turns on
- Special operation:
  - Other than the normal operation condition
  - When the compressor starts for the first time since the breaker turns on

## 1-5. Compressor frequency limitation by outdoor temperature

The minimum compressor frequency is limited by outdoor temperature as below.

- Cooling/Dry mode

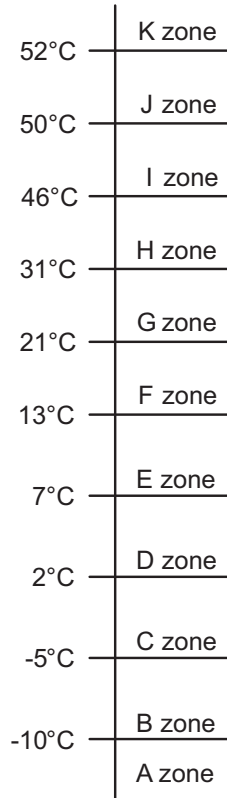

Model name	Outdoor temperature zone	Limitation of compressor frequency
ASYG30KMTA ASYG36KMTA	A zone	55 rps
	B zone	52 rps
	C zone	47 rps
	D zone	39 rps
	E zone	33 rps
	F zone	25 rps
	G zone	18 rps
	H zone	20 rps
	I zone	20 rps
	J zone	21 rps
	K zone	24 rps

- Heating mode

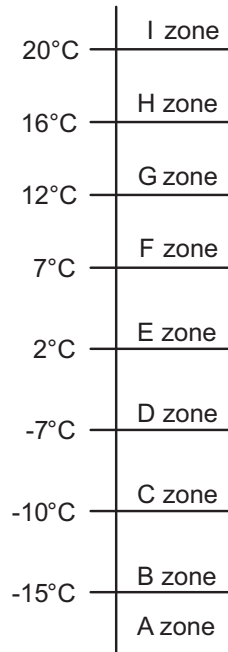

Model name	Outdoor temperature zone	Limitation of compressor frequency
ASYG30KMTA ASYG36KMTA	A zone	58 rps
	B zone	52 rps
	C zone	43 rps
	D zone	38 rps
	E zone	28 rps
	F zone	23 rps
	G zone	20 rps
	H zone	17 rps
	I zone	17 rps

## 2. Auto changeover operation

When the air conditioner is set to AUTO mode by remote controller, operation starts in the optimum mode from among heating, cooling, dry and monitoring modes. During operation, the optimum mode is automatically switched in accordance with temperature changes. The temperature can be set between 18°C and 30°C in 1.0°C steps.

- When operation starts, indoor fan and outdoor fan are operated for around 1 minute. Room temperature and outdoor temperature are sensed, and the operation mode is selected in accordance with the table below.

Room temperature	Operation mode
$Tr > Ts + 2^{\circ}\text{C}$	Cooling
$Ts + 2^{\circ}\text{C} \geq Tr \geq Ts - 2^{\circ}\text{C}$	Middle zone
$Tr < Ts - 2^{\circ}\text{C}$	Heating

Tr: Room temperature

Ts: Setting temperature

**NOTE:** When the operation mode is middle zone, indoor unit operation mode is selected as below.

- Same operation mode is selected as outdoor unit.  
If outdoor unit is operating in cooling and heating mode, indoor unit will be operated by the same operation mode.
- Selected by outdoor temperature.  
If outdoor unit is operating in other than cooling and heating mode, indoor unit will be operated according to the outdoor temperature as below.

Outdoor temp.	Operation mode
25°C or more	Cooling
Less than 25°C	Heating

- When the compressor was stopped for 6 consecutive minutes by temperature control function after the cooling or heating mode was selected as above, operation is switched to monitoring mode and the operation mode selection is done again.
- When the middle zone is selected on the predetermining of the operation mode, the operation mode before the changing to the monitoring mode is selected.

Operation flow chart

Ts: Setting temperature

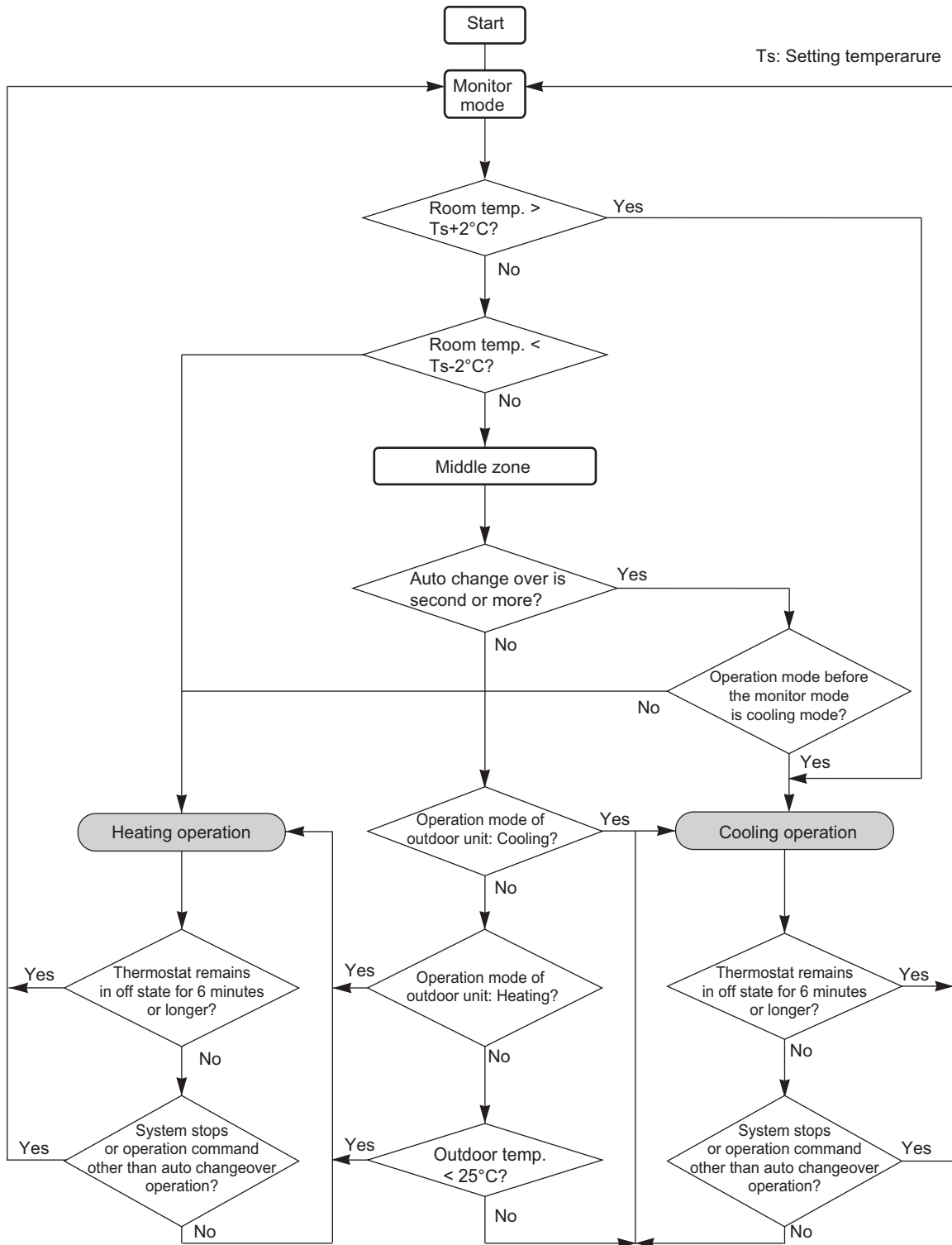

CONTROL AND FUNCTIONS

CONTROL AND FUNCTIONS

### 3. Fan control

Tr: Room temperature

Ts: Setting temperature

#### 3-1. Indoor fan control

##### ■ Fan speed

Indoor fan speed is defined as below.

Operation mode	Fan mode	Speed (rpm)
		ASYG30KMTA ASYG36KMTA
Heating	POWERFUL	1,520
	HIGH	1,330
	MED+	1,260
	MED	1,100
	LOW	950
	QUIET	780
	Cool air prevention	600
	S-LOW	540
Cooling/Fan	POWERFUL	1,520
	HIGH	1,330
	MED	1,100
	LOW	950
	QUIET	780
	Soft quiet	600* <sup>1</sup>
	S-LOW	540* <sup>2</sup>
Dry		X zone: 780 J zone: 680

\*1: Fan mode only

\*2: Cooling mode only



## ■ Fan operation

Airflow can be switched in 5 steps such as AUTO, QUIET, LOW, MED, HIGH while indoor unit fan only runs.

When fan mode is set at AUTO, it operates on MED fan speed.

## ■ Cooling operation

Switch the airflow AUTO, and indoor fan motor will run according to room temperature, as below.

On the other hand, if switched in HIGH—QUIET, indoor motor will run at a constant airflow of COOL operation modes QUIET, LOW, MED, HIGH as shown in “Fan speed” above.

Airflow change over (Cooling: Auto)

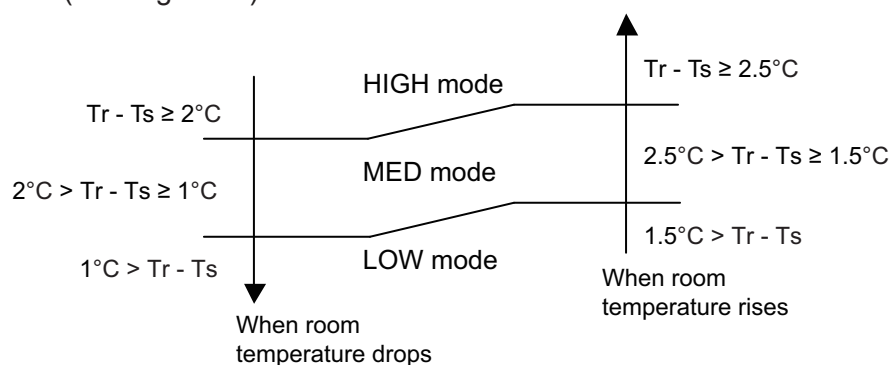

## ■ Dry operation

During dry operation, fan speed setting can not be changed as shown in “Fan speed” above.

## ■ Heating operation

Switch the airflow AUTO, and the indoor fan motor will run according to a room temperature, as below.

On the other hand, if switched in HIGH—QUIET, the indoor motor will run at a constant airflow of HEAT operation modes QUIET, LOW, MED, HIGH as shown in “Fan speed” above.

Airflow change over (Heating: Auto)

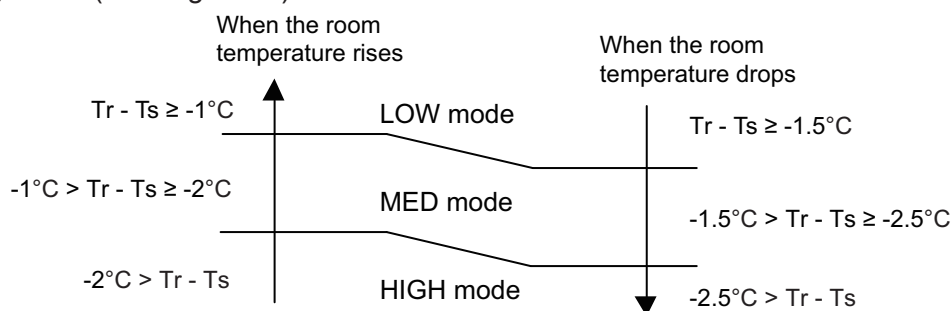

## ■ Cool air prevention control (heating mode)

The maximum value of the indoor fan speed is set as shown below, based on the detected temperature by the indoor heat exchanger sensor on heating mode.

- Normal operation

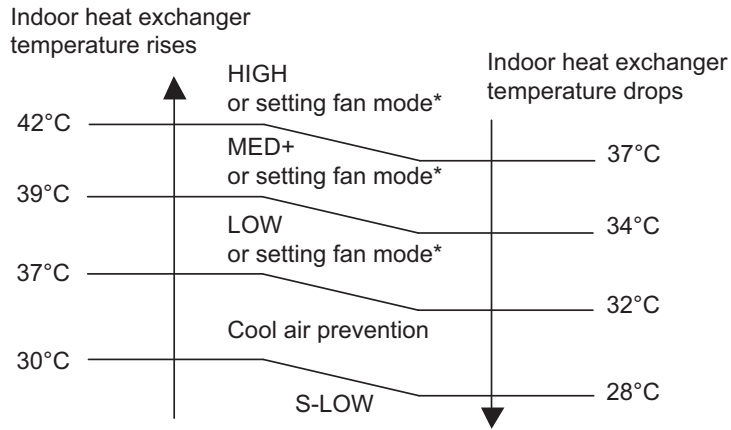

\*: Lower speed is selected.

7 minutes later:

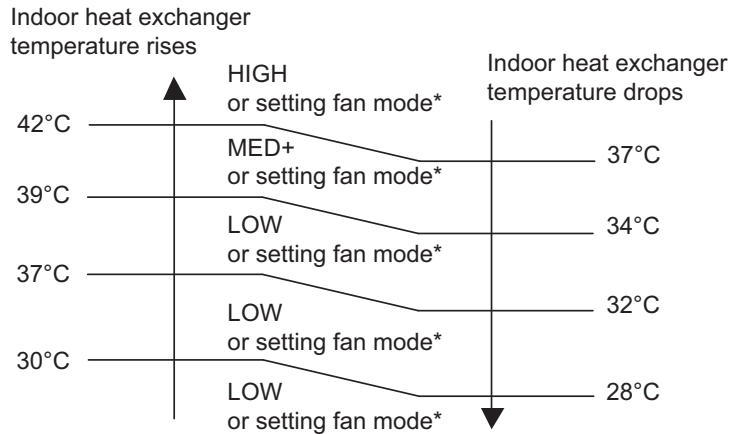

\*: Lower speed is selected.

CONTROL AND FUNCTIONS

CONTROL AND FUNCTIONS

• **Powerful operation**

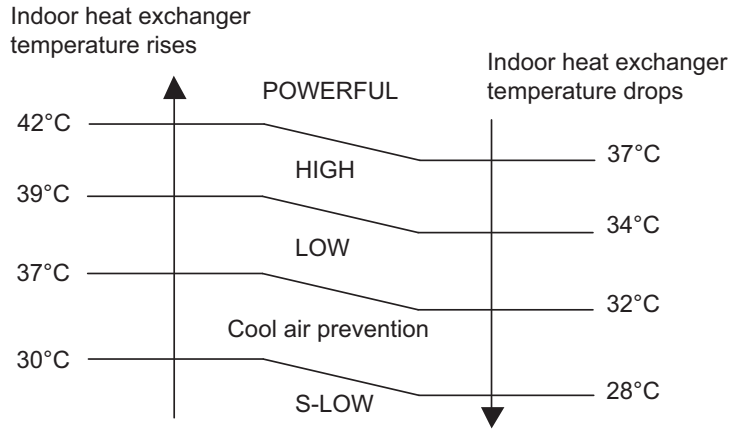

7 minutes later:

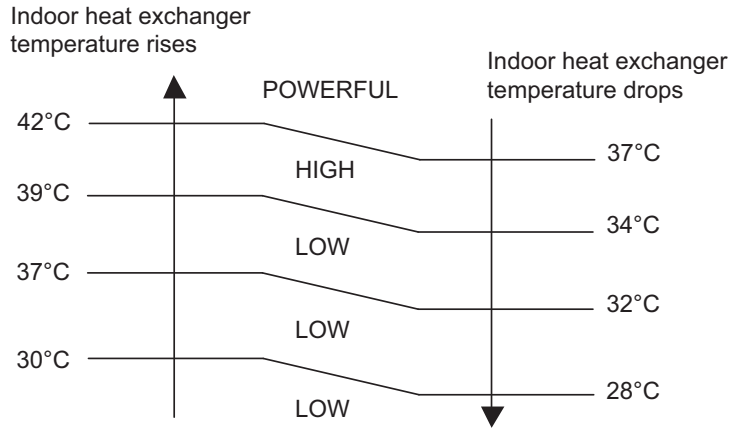

• **10 °C HEAT operation**

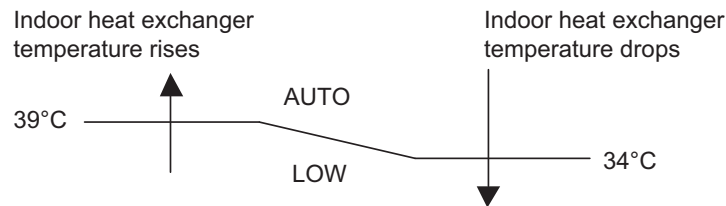

■ **Moisture return prevention control (cooling and dry mode)**

Switch the airflow AUTO at cooling mode, and the indoor fan motor will run as shown below.

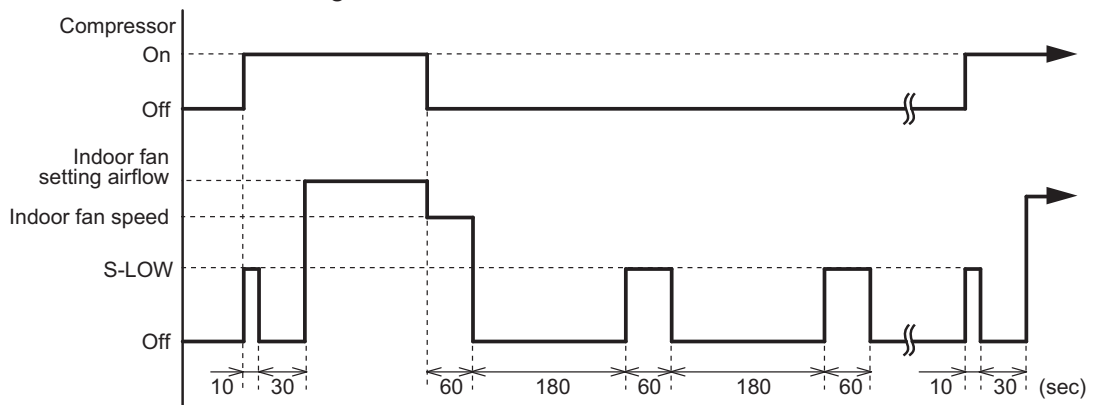

## 3-2. Outdoor fan control

### ■ Outdoor fan motor

This outdoor unit has a DC fan motor. (Control method is different between AC and DC motors.)

### ■ Fan speed

#### ● Models: AOYG30KMTA and AOYG36KMTA

Fan speed is defined by outdoor temperature and compressor frequency.

Unit: rpm

Fan step	Cooling or dry	Heating
13	830	—
12	830	—
11	740	—
10	700	830
9	650	740
8	570	690
7	570	620
6	540	590
5	510	480
4	480	410
3	480	340
2	400	270
1	270	200
S-HIGH	—	830

- When the compressor frequency increases, the outdoor fan speed also changes to the higher speed.
- When the compressor frequency decreases, the outdoor fan speed also changes to the lower speed.

**NOTE:** After defrost control on the heating mode, the fan speed is kept higher regardless of the compressor frequency.

Fan speed after defrost control: 830 rpm

## 4. Louver control

### 4-1. Vertical airflow direction louver control

Each time the button is pressed, the air direction range will change as below:

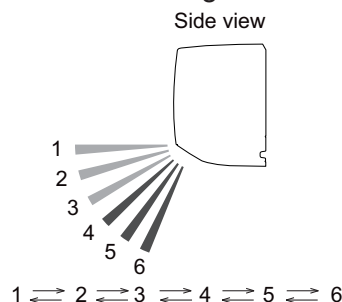

- Remote controller display is not changed.
- Vertical airflow direction is set automatically as shown, in accordance with the type of operation selected.

Cooling / Dry mode : Horizontal flow 1

Heating mode : Downward flow 5

- During AUTO operation, for the first a few minutes after beginning operation, airflow will be horizontal 1; the air direction cannot be adjusted during this period. The airflow direction setting will temporarily become 1 when the temperature of the airflow is low at the start of the Heating mode.
- After beginning of AUTO/HEAT mode operated and automatic defrosting operation, the airflow will be horizontal 1. However, the airflow direction cannot be adjusted at beginning AUTO operation mode.

### 4-2. Horizontal airflow direction louver control

Each time the button is pressed, the air direction range will change as below:

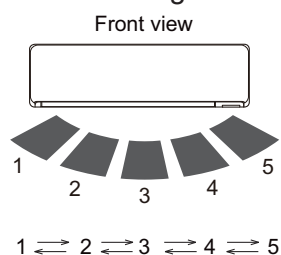

Remote controller display is not changed.

## 4-3. Swing operation

- To select vertical airflow swing operation  
When the swing signal is received, the vertical airflow direction louver starts to swing.
  - Swinging range
    - Cooling mode/dry mode/fan mode (1 to 3): 1 ↔ 4
    - Heating mode/fan mode (4 to 6): 3 ↔ 6
  - When the indoor fan is S-LOW or stop mode, the swing operation is interrupted and it stops at either upper end or bottom end.
  
- To select horizontal airflow swing operation  
When the swing signal is received, the horizontal airflow direction louver starts to swing.
  - Swinging range
    - All mode: 1 ↔ 5
  - When the indoor fan is S-LOW or stop mode, the swing operation is interrupted and it stops at either upper end or bottom end.
  
- To select vertical and horizontal airflow swing operation  
When the swing signal is received, both of the vertical and the horizontal airflow direction louver start to swing.

## 5. Timer operation control

### 5-1. Wireless remote control

On/Off timer	Program timer	Sleep timer	Weekly timer
○	○	○	○

#### ■ On/Off timer

- Off timer: When the clock reaches the set timer, the air conditioner will be turned off.

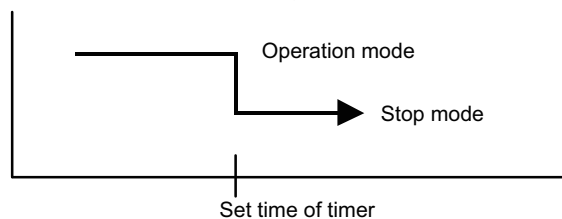

- On timer: When the clock reaches the set timer, the air conditioner will be turned on.

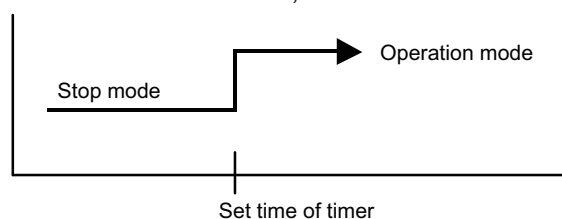

#### ■ Program timer

- The program timer allows the off timer and the on timer to be used in combination one time.

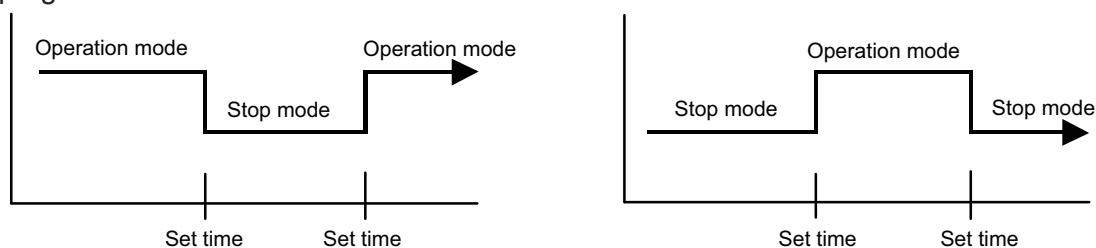

- Operation will start from the timer setting (either off timer and on timer) whichever is closest to the clock current timer setting. The order of operations is indicated by the allow in the remote controller screen.
- Sleep timer operation cannot be combined with on timer operation.

## ■ Sleep timer

If the sleep timer is set, the room temperature is monitored and the operation is stopped automatically. If the operation mode or the set temperature is change after the sleep timer is set, the operation is continued according to the changed setting of the sleep timer from that time on.

- In the cooling operation mode

When the sleep timer is set, the setting temperature is increased 1°C. It increases the setting temperature another 1°C after 1 hour. After that, the setting temperature is not changed and the operation is stopped at the setting time.

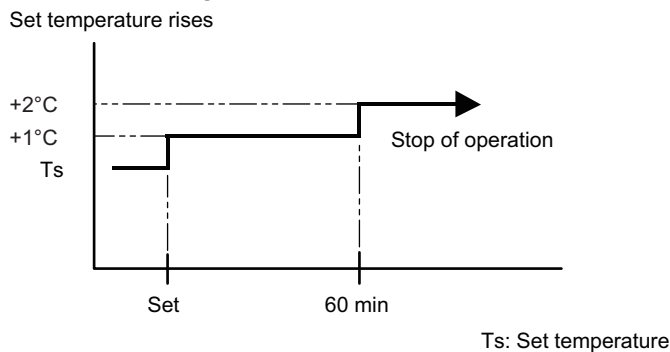

- In the heating operation mode

When the sleep timer is set, the setting temperature is decreased 1°C. It decreases the setting temperature another 1°C every 30 minutes. Upon lowering 4°C, the setting temperature is not changed and the operation is stopped at the setting time.

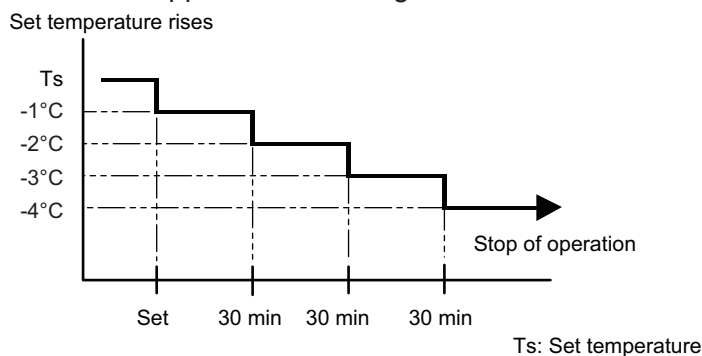

## ■ Weekly timer

On and off timer can be combined, and up to 4 reservations per day and 28 reservations per week. Before setting the program, set the week and time of the air conditioner at first. If the week and time are not set, the weekly timer will not operate correctly at the setting time.



## 5-2. Wired remote control

On/Off timer	Program timer	Sleep timer	Weekly timer	Temperature set back timer
○	○	○	○	○

### ■ On/Off timer

- Off timer: When the clock reaches the set timer, the air conditioner will be turned off.

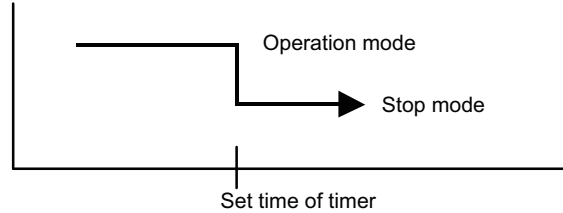

- On timer: When the clock reaches the set timer, the air conditioner will be turned on.

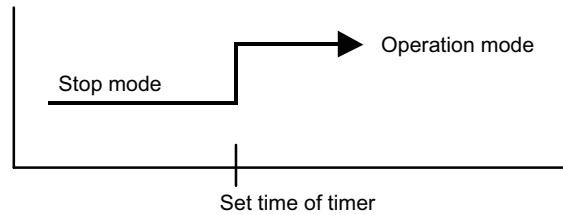

### ■ Program timer

- The program timer allows the off timer and the on timer to be used in combination one time.

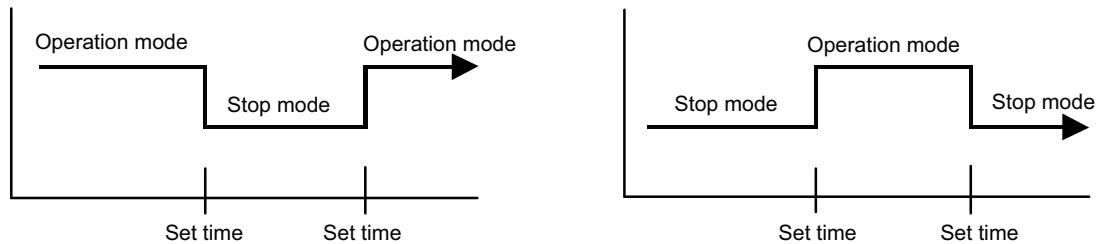

- Operation will start from the timer setting (either off timer and on timer) whichever is closest to the clock current timer setting. The order of operations is indicated by the allow in the remote controller screen.
- Sleep timer operation cannot be combined with on timer operation.

## ■ Sleep timer

If the sleep timer is set, the room temperature is monitored and the operation is stopped automatically. If the operation mode or the set temperature is change after the sleep timer is set, the operation is continued according to the changed setting of the sleep timer from that time on.

- In the cooling operation mode

When the sleep timer is set, the setting temperature is increased 1°C. It increases the setting temperature another 1°C after 1 hour. After that, the setting temperature is not changed and the operation is stopped at the setting time.

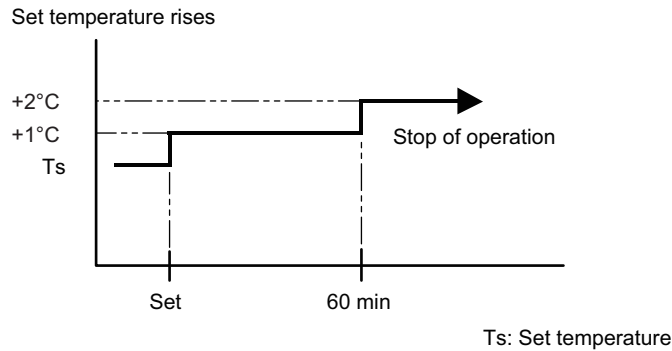

- In the heating operation mode

When the sleep timer is set, the setting temperature is decreased 1°C. It decreases the setting temperature another 1°C every 30 minutes. Upon lowering 4°C, the setting temperature is not changed and the operation is stopped at the setting time.

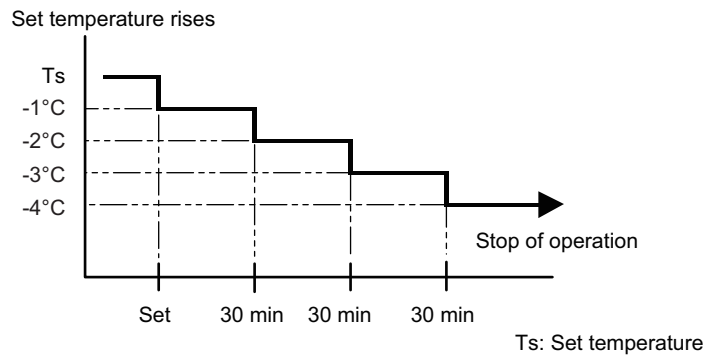

## ■ Weekly timer

On and off timer can be combined, and up to 4 reservations per day and 28 reservations per week. Before setting the program, set the week and time of the air conditioner at first. If the week and time are not set, the weekly timer will not operate correctly at the setting time.

## ■ Temperature set back timer

- The SET BACK timer only changes the set temperature for 7 days, it cannot be used to start or stop air conditioner operation.
- The SET BACK timer can be set to operate up to two times per day but only one temperature setting can be used.
- During COOLING/DRY mode, the air conditioner will operate at a minimum of 18°C even if the SET BACK temperature is set to 17°C or lower.

Case of SET BACK timer on the Cooling operation. (Setting temperature :22°C, SET BACK temperature :26°C)

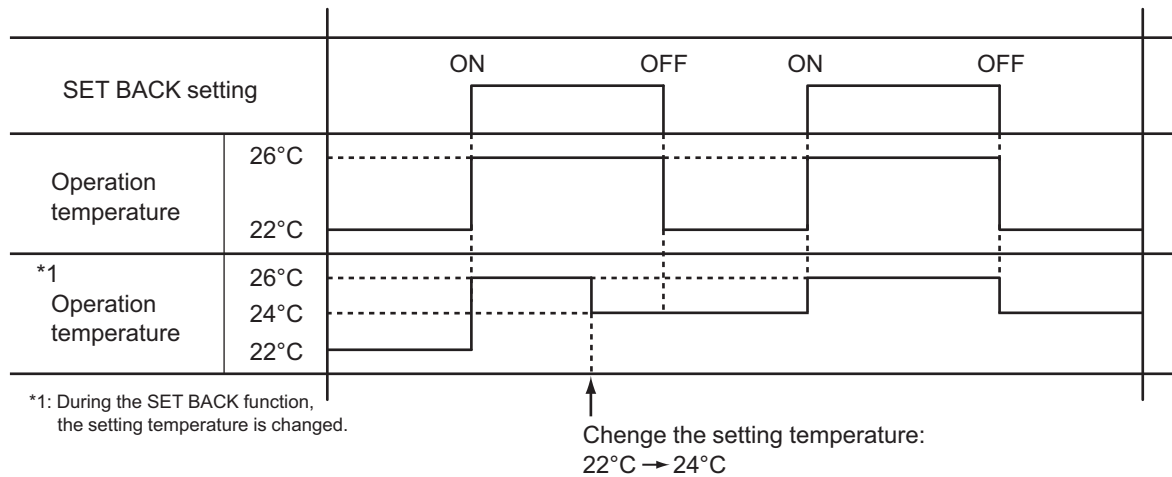

## 6. Defrost operation control

Tn: Outdoor unit heat exchanger temperature

Ta: Outdoor temperature

Tn10: Temperature at 10 minutes after compressor start

Tnb: Temperature before 5 minutes

### • Triggering condition

The defrost operation starts when outdoor unit heat exchanger temperature sensor detects the temperature lower than the values shown below.

#### – 1st time defrosting after starting operation

Compressor integrating operation time	Less than 17 min.	17 to 57 min.	More than 57 min.
Condition	Does not operate	$T_n \leq -9^\circ\text{C}$ and $T_n - T_a \geq 5$ deg	$T_n \leq -5^\circ\text{C}$

#### – 2nd time and after

Compressor integrating operation time	Less than 35 min.	More than 35 min.
Condition	Does not operate	$T_n - T_{n10} < -5$ deg ( $T_n \leq -10^\circ\text{C}$ ) $T_n - T_{nb} < -2$ deg ( $T_n \leq -10^\circ\text{C}$ ) $T_n \leq -25^\circ\text{C}$ ( $T_a \geq -20^\circ\text{C}$ ) $T_n < T_a - 7^\circ\text{C}$ or $T_n \leq -25^\circ\text{C}$ ( $T_a < -20^\circ\text{C}$ )

#### – Integrating defrost (Constant monitoring)

Compressor integrating operation time	More than 240 min. (For long continuous operation)	More than 215 min. (For long continuous operation)	Less than 10 min.* (For intermittent operation)
Condition	$T_n \leq -3^\circ\text{C}$	$T_n \leq -5^\circ\text{C}$	Count of the compressor off: 40 times

\*: If the compressor continuous operation time is less than 10 minutes, the number of the compressor off is counted. If any defrost operated, the compressor off count is cleared.

### • Release condition

The defrost operation is released when either one of the conditions below is satisfied.

Outdoor unit heat exchanger temperature (after 1 minute or later since compressor start)	12°C or more
Compressor operation time	15 minutes

## 6-1. Defrost operation in heating operation stopped

If the outdoor unit is frosted when stopping the heating operation, it stops after performing the automatic defrosting operation.

In this time, if the indoor unit operation lamp flashes slowly (6 sec on/2 sec off), the outdoor unit allow the heat exchanger to defrost, and then stop.

### • Triggering condition

When all of the following conditions are satisfied in heating operation

- Compressor operation integrating time: 30 minutes or more
- Compressor continuous operation time: 10 minutes or more
- Outdoor unit heat exchanger temperature: -4°C or less

### • Release condition

The defrost operation is released when either one of the conditions below is satisfied.

Outdoor unit heat exchanger temperature (after 1 minute or later since compressor start)	12°C or more
Compressor operation time	15 minutes

## 7. Various control

### 7-1. Auto restart

When the power was interrupted by a power failure etc. during operation, the operation contents at that time are memorized and when the power is recovered, operation is automatically started with the memorized operation contents.

Operation contents memorized when the power is interrupted
Operation mode
Setting temperature
Fan mode setting
Timer mode and set time (set by wireless remote controller)
Airflow direction setting
Swing
ECONOMY operation
10 °C HEAT operation
Remote control setting
WLAN LED setting

### 7-2. MANUAL AUTO operation

When the wireless remote controller is lost or battery power dissipated, this function will work without the remote controller.

When MANUAL AUTO button is pressed more than 3 seconds and less than 10 seconds, MANUAL AUTO operation starts as shown in the table below. To stop operation, press the MANUAL AUTO button for 3 seconds.

Operation mode	Auto changeover
Fan mode	AUTO
Timer mode	Continuous (no timer setting available)
Setting temperature	24°C
Vertical airflow direction louver setting	Standard
Horizontal airflow direction louver setting	According to memory position
SWING	Off
ECONOMY	Off
Human sensor	Off

## 7-3. Forced cooling operation

The outdoor unit may not operate depending on the room temperature.

When FORCED COOLING OPERATION button is pressed more than 10 seconds, forced cooling operation starts as shown in the table below.

Operation mode	Cooling
Fan mode	HIGH
Timer mode	Continuous (no timer setting available)
Setting temperature	24°C
Vertical airflow direction louver setting	Standard
Horizontal airflow direction louver setting	According to memory position
SWING	Off
ECONOMY	Off
Human sensor	Off

- During the forced cooling operation, it operates regardless of room temperature sensor.
- Operation LED and timer LED blink at the same time during the forced cooling operation. They blink for 1 second ON and 1 second OFF on both operation LED and timer LED (same as test operation).

By performing one of the following action, test operation will be canceled:

- Pressing the remote controller START/STOP button
- Pressing FORCED COOLING OPERATION button for 3 seconds
- 60 minutes passed after starting forced cooling operation

**NOTE:** When HEAT operation is selected on the remote controller during forced cooling operation, heating test run will begin in about 3 minutes.

## 7-4. 10 °C HEAT operation

10 °C HEAT operation performs as below setting when pressing 10 °C HEAT button.

Operation mode	Heating
Setting temperature	10°C
Fan mode	AUTO
LED display	Economy
Defrost operation	Operate as normal

## 7-5. ECONOMY operation

The ECONOMY operation starts by pressing ECONOMY button on the remote controller.

The ECONOMY operation is almost the same operation as below settings.

Mode	Cooling/Dry	Heating
Target temperature	Setting temperature +1°C	Setting temperature -1°C

## 7-6. POWERFUL operation

The POWERFUL operation starts by pressing POWERFUL button on the remote controller. The indoor unit and outdoor unit operate at maximum power as shown in the table below.

Compressor frequency		Maximum
Fan mode		POWERFUL
Vertical airflow direction louver setting	Cooling	3
	Dry	
	Heating	5

### Release condition:

- Cooling/Dry  
Room temperature  $\leq$  Setting temperature  $-0.5^{\circ}\text{C}$  or Operation time has passed 20 minutes.
- Heating  
Room temperature  $\geq$  Setting temperature  $+0.5^{\circ}\text{C}$  or Operation time has passed 20 minutes.

## 7-7. Fresh air control

The fan motor for Fresh Air is operated in synchronization with the indoor fan operation as below.

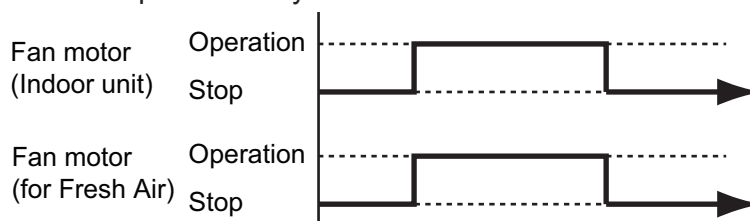

## 7-8. Compressor preheating

By preheating the compressor, warm airflow is quickly discharged when the operation is started.

- **Triggering condition 1**
  - Outdoor temperature  $\leq 20^{\circ}\text{C}$   
When outdoor temperature reaches  $26^{\circ}\text{C}$ , compressor preheating stops.
  - 30 minutes after compressor stopped
- **Triggering condition 2**

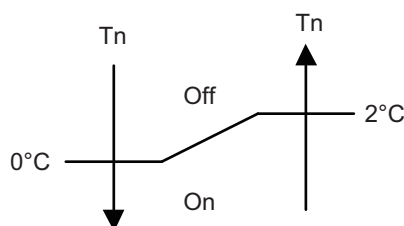

$T_n$ : Outdoor unit heat exchanger temp.



## 7-9. External electrical heater control

The external electrical heater is operated as below.

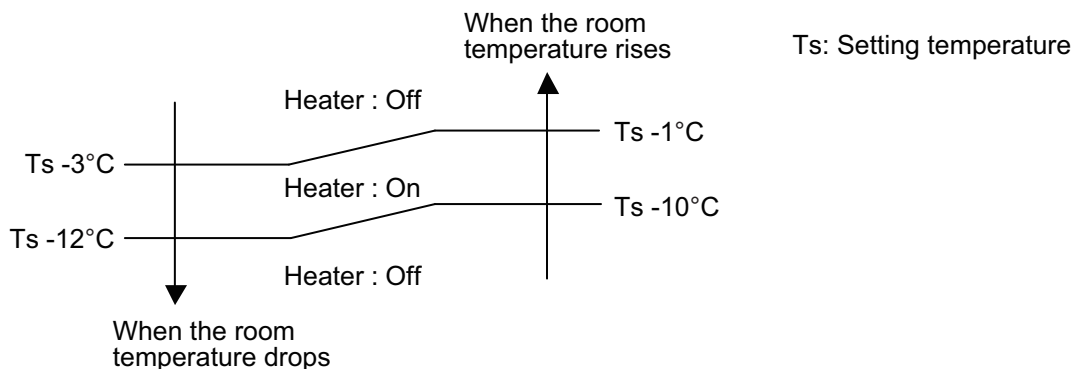

### NOTES:

- When the compressor stop, external electric heater is off.
- It operates only in heating mode and when the indoor fan operates. (However, S-LOW is excluded.)

## 7-10. Electronic expansion valve control

The most proper opening of the electronic expansion valve is calculated and controlled under the present operating condition based on the table below.

Operation mode	Pulse range
Cooling/dry mode	Between 47 and 480 pulses
Heating mode	Between 39 and 480 pulses

**NOTE:** At the time of supplying the power to the outdoor unit, the initialization of the electronic expansion valve is operated (528 pulses are input to the closing direction).

## 7-11. Prevention to restart for 3 minutes (3 minutes st)

When the compressor fails to start for the number of times below, it does not enter operation status for 3 minutes.

Retry number	30
Retry set number	3

When the compressor fails to start in the retry set number above, the compressor is stopped.

## 7-12. 4-way valve control

- If heating mode is selected at the compressor start, 4-way valve is energized for heating.
- When the air conditioner is switched between cooling and heating mode, compressor is stopped, and the 4-way valve is switched when the 3 minutes passes and the compressor is started.

## 7-13. Human sensor for energy saving

If no one enters the room for approximately 20 minutes, the set temperature is automatically controlled. (When someone comes back into the room, the human sensor detect this, and automatically revert to the original settings.)

Operation mode	Operation details (If there is no one in the room for a while)
Cool/Dry	The setting temperature is increased by maximum 2°C. (Maximum setting temperature: 30°C)
Heat	The setting temperature is decreased by maximum 4°C. (Minimum setting temperature: 16°C)
Auto	Energy saving function is performed automatically for the selected mode (cool/heat/dry).

- Application range:

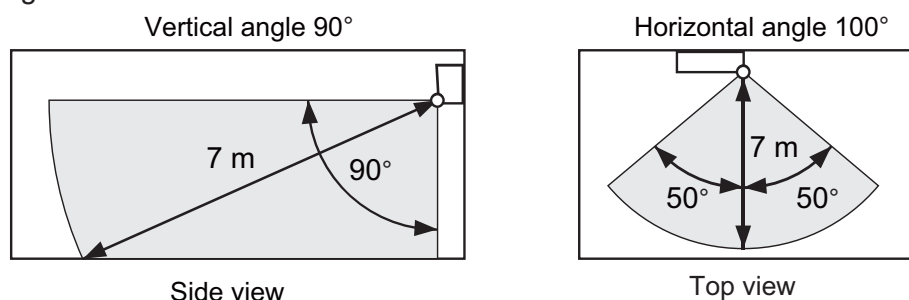

Energy saving function may not work when the room temperature is very different from the temperature defined in the temperature setting, such as when immediately after starting the operation.

- Details about detection with the human sensor:  
The human sensor detects whether there are people in the room by looking for movement by people in the room.

## 7-14. Peak cut operation

The current value is limited to reduce the power consumption by external input.

Peak cut level	Level 1	Level 2	Level 3	Level 4
Peak cut for rated capacity	Forced thermostat off	50%	75%	100%

### NOTES:

- During defrost operation, peak cut operation becomes invalid.
- Even during the peak cut operation, the operations of current overload, economy, and low noise are effective and the outdoor unit operates by lowest current of them.

## 8. Various protections

### 8-1. Discharge gas temperature over-rise prevention control

The discharge gas temperature sensor (discharge thermistor: outdoor unit side) detects the discharge gas temperature.

- When the discharge temperature becomes higher than the trigger condition, the compressor frequency is decreased as the table below, and it continues to decrease until the discharge temperature becomes lower than the trigger condition.
- When the discharge temperature becomes lower than the release condition, control of compressor frequency is released.
- When the discharge temperature becomes higher than the compressor protection temperature, the compressor is stopped and the indoor unit LED starts blinking.

Trigger condition	104°C
Compressor frequency	-14 rps/120 seconds
Release condition	101°C
Compressor protection temperature	110°C

### 8-2. Anti-freezing control (cooling and dry mode)

The compressor frequency is decrease in cooling and dry mode when the indoor unit heat exchanger temperature sensor detects the temperature lower than the trigger condition.

When the indoor unit heat exchanger temperature reaches release condition, the anti-freezing control is stopped.

Trigger condition	4°C	
Release condition	Outdoor temp. $\geq 10^{\circ}\text{C}^{*1}$	7°C
	Outdoor temp. $\geq 12^{\circ}\text{C}^{*2}$	
	Outdoor temp. $< 10^{\circ}\text{C}^{*1}$	13°C
	Outdoor temp. $< 12^{\circ}\text{C}^{*2}$	

\*1: During the outdoor temperature dropping

\*2: During the outdoor temperature rising

## 8-3. Current release control

The compressor frequency is controlled so that the outdoor unit input current does not exceeds current limit value set according to the outdoor temperature.

The compressor frequency returns according to the operation mode, when the current becomes lower than the release value.

### ■ Models: AOYG30KMTA and AOYG36KMTA

Operation mode	Outdoor temp. (Ta)	Trigger condition	Release condition
Cooling	$52^{\circ}\text{C} \leq \text{Ta}$	8.0 A	7.5 A
	$50^{\circ}\text{C} \leq \text{Ta} < 52^{\circ}\text{C}$	12.0 A	11.5 A
	$42^{\circ}\text{C} \leq \text{Ta} < 50^{\circ}\text{C}$	14.0 A	13.5 A
	$2^{\circ}\text{C} \leq \text{Ta} < 42^{\circ}\text{C}$	18.0 A	17.5 A
	$\text{Ta} < 2^{\circ}\text{C}$	20.0 A	19.5 A
Heating	$20^{\circ}\text{C} \leq \text{Ta}$	10.0 A	9.5 A
	$16^{\circ}\text{C} \leq \text{Ta} < 20^{\circ}\text{C}$	11.0 A	10.5 A
	$12^{\circ}\text{C} \leq \text{Ta} < 16^{\circ}\text{C}$	13.5 A	13.0 A
	$2^{\circ}\text{C} \leq \text{Ta} < 12$	18.0 A	17.5 A
	$\text{Ta} < 2^{\circ}\text{C}$	20.0 A	19.5 A

## 8-4. Compressor temperature protection

When the compressor temperature sensor detects higher than the trigger condition below, the compressor is stopped. When the compressor temperature sensor detects the release condition, the protection is released.

Trigger condition	108°C
Release condition	80°C (3 minutes after compressor stop)

## 8-5. High pressure protection

Trigger condition	Pressure switch: Off (Open: Higher than 4.2 MPa) Compressor stop
Release condition	Pressure switch: On (Close: Lower than 3.2 MPa) (3 minutes after compressor stop) Compressor restart

## 8-6. Low outdoor temperature protection

When the outdoor temperature sensor detects lower than the trigger condition below, the compressor is stopped.

Operation mode	Cooling/Dry	Heating
Trigger condition		-20°C
Release condition		-15°C

## 8-7. High temperature and high pressure release control

The compressor is controlled as follows.

### ■ Models: AOYG30KMTA and AOYG36KMTA

#### • Cooling mode

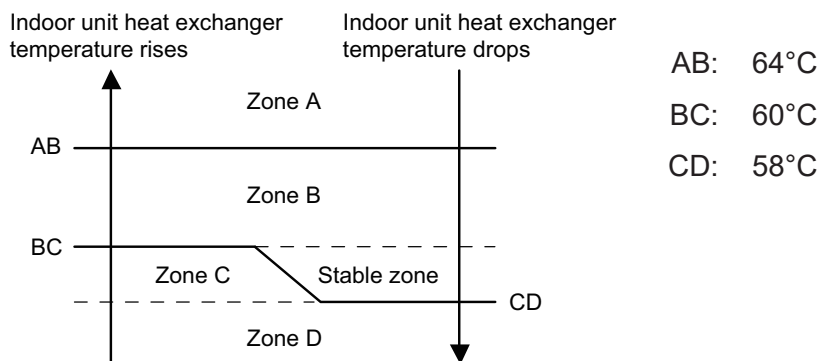

Zone	Operation	
Zone A	Compressor is stopped.	
Zone B	The compressor frequency is decreased.	-7 rps/120 sec.
Zone C	The protection is released and the operation is returned to normal mode.	
Zone D		

#### • Heating mode

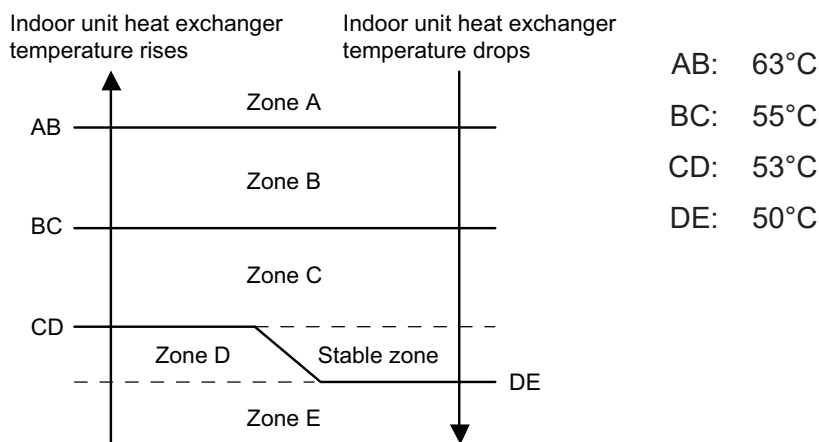

Zone	Operation	
Zone A	Compressor is stopped.	
Zone B	The compressor frequency is decreased.	-15 rps/120 sec.
Zone C		-2 rps/120 sec.
Zone D	The protection is released and the operation is returned to normal mode.	
Zone E		



## **5. FILED WORKING**

# CONTENTS

## 5. FILED WORKING

<b>1. Function settings</b> .....	<b>05-1</b>
1-1. Function settings by using remote controller .....	05-1
1-2. Function settings on outdoor unit.....	05-7



# 1. Function settings

To adjust the functions of this product according to the installation environment, various types of function settings are available.

**NOTE:** Incorrect settings can cause a product malfunction.

## 1-1. Function settings by using remote controller

Some function settings can be changed on the remote controller. After confirming the setting procedure and the content of each function setting, select appropriate functions for your installation environment.

### ■ Setting procedure by using wireless remote controller

The function number and the associated setting value are displayed on the LCD of the remote controller. Follow the instructions written in the local setup procedure supplied with the remote controller, and select appropriate setting according to the installation environment.

**Before connecting the power supply of the indoor unit, reconfirm following items:**

- Cover for the electrical enclosure on the outdoor unit is in place.
- There is no wiring mistake.
- Piping air tight test and vacuuming have been performed firmly.
- All the necessary wiring work for outdoor unit has been finished.

After reconfirming the items listed above, connect the power supply of the indoor unit.

#### NOTES:

- Settings will not be changed if invalid numbers or setting values are selected.
- When optional wired remote controller is used, refer to the installation manual enclosed with the remote controller.

#### Entering function setting mode:

While pressing the POWERFUL button and TEMP. (^) button simultaneously, press the RESET button to enter the function setting mode.

#### Selecting the function number and setting value:

1. Press the TEMP. (^) (v) buttons to select the function number. To switch between the left and right digits, press the 10 °C HEAT button.
2. Press the POWERFUL button to proceed to value setting. To return the function number selection, press the POWERFUL button again.
3. Press the TEMP. (^) (v) buttons to select the setting value. To switch between the left and right digits, press the 10 °C HEAT button.
4. Press the MODE button once. Confirm that you hear the beep sound.
5. Press the START/STOP button to fix the function setting. Confirm that you hear the beep sound.
6. Press the RESET button to end the function setting mode.
7. After completing the function setting, be sure to disconnect the power supply and then reconnect it.

Function number  
Setting value

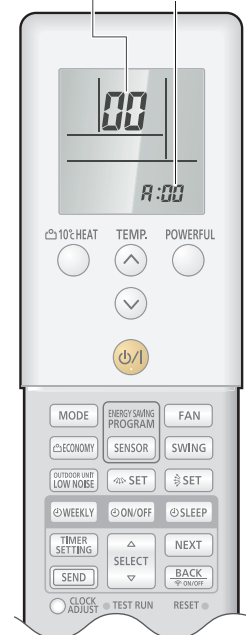

#### ⚠ CAUTION

After disconnecting the power supply, wait 30 seconds or more before reconnecting it. The function setting will not become active unless the power supply is disconnected and then reconnected.

**NOTES:**

- The air conditioner custom code is set to  $\overline{H}$  prior to shipment.
- If you do not know the air conditioner custom code setting, try each of the custom codes ( $\overline{H} \rightarrow \overline{b}$   
 $\rightarrow \overline{c} \rightarrow \overline{d}$ ) until you find the code that operates the air conditioner.

## ■ Contents of function setting

Each function setting listed in this section is adjustable in accordance with the installation environment.

**NOTE:** Setting will not be changed if invalid numbers or setting values are selected.

### ● Function setting list

	Function no.	Functions
1)	00	Remote controller address setting
2)	11	Filter sign
3)	30/31	Room temperature control for indoor unit sensor
4)	35/36	Room temperature control for wired remote controller sensor
5)	40	Auto restart
6)	42	Room temperature sensor switching
7)	44	Remote controller custom code
8)	46	External input control
9)	48	Room temperature sensor switching (Aux.)
10)	49	Indoor unit fan control for energy saving for cooling

#### 1) Remote controller address setting

**NOTE:** Because this setting is normally done automatically when 2-wire-type wired remote controller is installed, setting is unnecessary.

Multiple indoor units can be operated by using one wired remote controller.

Set the unit number of each indoor unit.

Function number	Setting value	Setting description	Factory setting
00	00	Unit no. 0	◆
	01	Unit no. 1	
	02	Unit no. 2	
	03	Unit no. 3	
	04	Unit no. 4	
	05	Unit no. 5	
	06	Unit no. 6	
	07	Unit no. 7	
	08	Unit no. 8	
	09	Unit no. 9	
	10	Unit no. 10	
	11	Unit no. 11	
	12	Unit no. 12	
	13	Unit no. 13	
	14	Unit no. 14	
15	Unit no. 15		

**NOTE:** When different type of indoor units (such as wall mounted type and cassette type, cassette type and duct type, or other combinations) are connected using group control system, some functions may no longer be available.

## 2) Filter sign

Select appropriate intervals for displaying the filter sign on the indoor unit according to the estimated amount of dust in the air of the room.

If the indication is not required, select "No indication" (03).

Function number	Setting value	Setting description	Factory setting
11	00	Standard (400 hours)	
	01	Long interval (1,000 hours)	
	02	Short interval (200 hours)	
	03	No indication	◆

## 3) Room temperature control for indoor unit sensor

Depending on the installed environment, correction of the room temperature sensor may be required. Select the appropriate control setting according to the installed environment.

The temperature of the room temperature sensor is corrected as follows:

Corrected temp. = Temp. of the room temp. sensor - Correction temp. value

Example of correction:

When the temperature of the room temp. sensor is 26°C and the setting value is "03" (-1.0°C), corrected temp. will be 27°C (26°C - [-1.0°C]).

The temperature correction values show the difference from the Standard setting "00" (manufacturer's recommended value).

Function number		Setting value	Setting description	Factory setting	
30 (For cooling)	31 (For heating)	00	Standard setting	◆	
		01	No correction 0.0 °C		
		02	-0.5 °C	More cooling Less heating	
		03	-1.0 °C		
		04	-1.5 °C		
		05	-2.0 °C		
		06	-2.5 °C		
		07	-3.0 °C		
		08	-3.5 °C		
		09	-4.0 °C		
		10	+0.5 °C	Less cooling More heating	
		11	+1.0 °C		
		12	+1.5 °C		
		13	+2.0 °C		
		14	+2.5 °C		
		15	+3.0 °C		
		16	+3.5 °C		
17	+4.0 °C				

#### 4) Room temperature control for wired remote controller sensor

Depending on the installed environment, correction of the wire remote temperature sensor may be required. Select the appropriate control setting according to the installed environment.

To change this setting, set Function 42 to Both "01".

Ensure that the Thermo Sensor icon is displayed on the remote controller screen.

Function number		Setting value	Setting description	Factory setting	
35 (For cooling)	36 (For heating)	00	Standard setting	◆	
		01	No correction 0.0°C		
		02	-0.5 °C	More cooling Less heating	
		03	-1.0 °C		
		04	-1.5 °C		
		05	-2.0 °C		
		06	-2.5 °C		
		07	-3.0 °C		
		08	-3.5 °C		
		09	-4.0 °C		
		10	+0.5 °C	Less cooling More heating	
		11	+1.0 °C		
		12	+1.5 °C		
		13	+2.0 °C		
		14	+2.5 °C		
		15	+3.0 °C		
		16	+3.5 °C		
		17	+4.0 °C		

#### 5) Auto restart

Enables or disables automatic restart after a power interruption.

Function number	Setting value	Setting description	Factory setting
40	00	Enable	◆
	01	Disable	

**NOTE:** Auto restart is an emergency function such as for power outage etc. Do not attempt to use this function in normal operation. Be sure to operate the unit by remote controller or external device.

#### 6) Room temperature sensor switching

(Only for wired remote controller)

When using the wired remote controller temperature sensor, change the setting to "Both" (01).

Function number	Setting value	Setting description	Factory setting
42	00	Indoor unit	◆
	01	Both	

00: Sensor on the indoor unit is active.

01: Sensors on both indoor unit and wired remote controller are active.

**NOTE:** Remote controller sensor must be turned on by using the remote controller.

**7) Remote controller custom code**

(Only for wireless remote controller)

The indoor unit custom code can be changed. Select the appropriate custom code.

Function number	Setting value	Setting description	Factory setting
44	00	A	◆
	01	B	
	02	C	
	03	D	

**8) External input control**

"Operation/Stop" mode or "Forced stop" mode can be selected.

Function number	Setting value	Setting description	Factory setting
46	00	Operation/Stop mode 1	◆
	01	(Setting prohibited)	
	02	Forced stop mode	
	03	Operation/Stop mode 2	

**NOTE:** If this function is necessary, the rotary switch on the External input and output PCB should be set to 1.

**9) Room temperature sensor switching (Aux.)**

To use the temperature sensor on the wired remote controller only, change the setting to "Wired remote controller" (01).

This function will only work if the function setting 42 is set at "Both" (01).

When the setting value is set to "Both" (00), more suitable control of the room temperature is possible by setting function setting 30 and 31 too.

Function number	Setting value	Setting description	Factory setting
48	00	Both	◆
	01	Wired remote controller	

**10) Indoor unit fan control for energy saving for cooling**

Enables or disables the power-saving function by controlling the indoor unit fan rotation when the outdoor unit is stopped during cooling operation.

Function number	Setting value	Setting description	Factory setting
49	00	Disable	
	01	Enable	
	02	Remote controller	◆

00: When the outdoor unit is stopped, the indoor unit fan operates continuously following the setting on the remote controller.

01: When the outdoor unit is stopped, the indoor unit fan operates intermittently at a very low speed.

02: Enable or disable this function by remote controller setting.

**NOTES:**

- As the factory setting, this setting is initially activated.
- Set to "00" or "01" when connecting a remote controller that cannot set the Fan control for energy saving function or connecting a network converter.  
To confirm if the remote controller has this setting, refer to the operating manual of each remote controller.

## 1-2. Function settings on outdoor unit

Perform appropriate function setting locally according to the installation environment.

**NOTE:** Incorrect settings can cause a product malfunction.

### ⚠ CAUTION

- Before setting up the switch buttons, discharge the static electricity from your body.
- Never touch the terminals or the patterns on the parts that are mounted on the PCB.

### ■ Control PCB and switch buttons location

Control PCB of the outdoor unit is located as shown in the following figure.

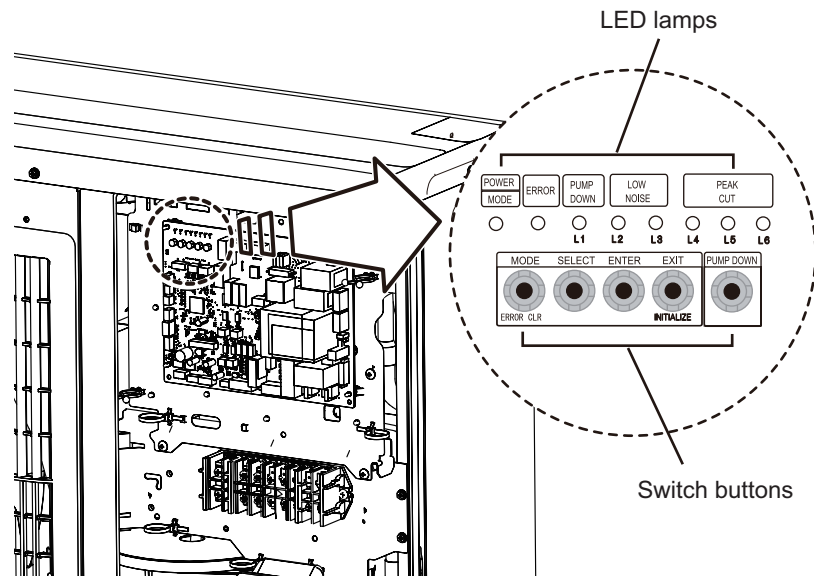

## ● Switch buttons and the functions

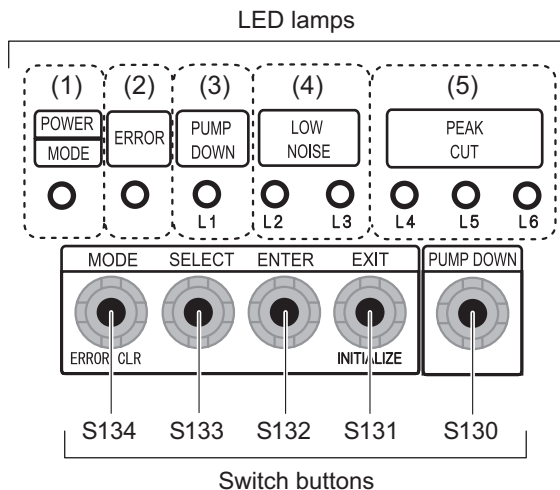

LED lamp		Function or operation method	
(1)	POWER/MODE	Green	Lights on while power on. Local setting in outdoor unit or error code is displayed with blink.
(2)	ERROR	Red	Blinks during error operation.
(3)	PUMP DOWN (L1)	Orange	Lights on during pump down operation.
(4)	LOW NOISE MODE (L2 and L3)	Orange	Lights on during "Low noise mode" when local setting is activated. (Lighting pattern of L2 and L3 indicates low noise level.)
(5)	PEAK CUT MODE (L4, L5, and L6)	Orange	Lights on during "Peak cut mode" when local setting is activated. (Lighting pattern of L4, L5, and L6 indicates peak cut level.)

Switch button		Function or operation method	
S134	MODE	Switches between "Local setting" and "Error code display".	
S133	SELECT	Switches between the individual "Local settings" and the "Error code displays".	
S132	ENTER	Switches between the individual "Local settings" and the "Error code displays".	
S131	EXIT	Returns to "Operation status display".	
S130	PUMP DOWN	Starts the pump down operation.	

FIELD WORKING

FIELD WORKING



## Local setting procedure

**NOTE:** Before performing the function setting, be sure to stop the operation of the air conditioner.

### Low noise mode

1. Press the MODE switch button (S134) for 3 seconds or more to switch to “Local setting mode”.
2. After confirming the LED lamp of POWER/MODE blinks 9 times, press the ENTER switch button (S132).

POWER MODE	ERROR	PUMP DOWN (L1)	LOW NOISE (L2) (L3)		PEAK CUT (L4) (L5) (L6)		
Blinks (9 times)	○	○	○	○	○	○	○

Sign “○”: Lights off

3. Press the SELECT switch button (S133), and adjust the LED lamp as shown below. Then the LED lamp indicates the current setting.

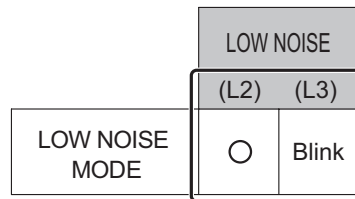

4. Press the ENTER switch button (S132).

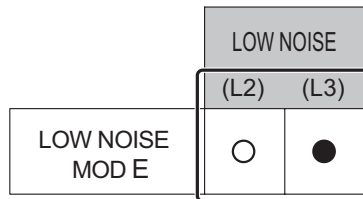

Sign “●”: Lights on

5. Press the SELECT switch button (S133), and adjust the LED lamps as shown below.

	PEAK CUT (L4) (L5) (L6)		
MODE 1: Low	○	○	Blink
MODE 2: Lower	○	Blink	○

6. Press the ENTER switch button (S132) and fix it.

	PEAK CUT (L4) (L5) (L6)		
MODE 1: Low	○	○	●
MODE 2: Lower	○	●	○

7. To return to “Operating status display (Normal operation)”, press the EXIT switch button (S131).

#### In case of missing how many times you pressed the SELECT and ENTER switch buttons:

1. To return to “Operation status display (Normal operation)”, press the EXIT switch button once.
2. Restart from the beginning of setting procedure.

**NOTE:** In case of missing how many times you pressed the SELECT and ENTER switch buttons, you must redo the setting procedure. Return to “Operation status display (Normal operation)” by pressing the EXIT switch button once, and restart from the beginning of the setting procedure.

## ● Peak cut mode

1. Press the MODE switch button (S134) for 3 seconds or more to switch to “Local setting mode”.
2. After confirming the LED lamp of POWER/MODE blinks 9 times, press the ENTER switch button (S132).

POWER MODE	ERROR	PUMP DOWN (L1)	LOW NOISE (L2) (L3)		PEAK CUT (L4) (L5) (L6)		
Blinks (9 times)	○	○	○	○	○	○	○

Sign “○”: Lights off

3. Press the SELECT switch button (S133), and adjust the LED lamp as shown below. Then the LED lamp indicates the current setting.

		LOW NOISE	
		(L2)	(L3)
PEAK CUT MODE	Blink	○	

4. Press the ENTER switch button (S132).

		LOW NOISE	
		(L2)	(L3)
PEAK CUT MODE	●	○	

Sign “●”: Lights on

5. Press the SELECT switch button (S133), and adjust the LED lamps as shown below.

	PEAK CUT		
	(L4)	(L5)	(L6)
0 % of rated input ratio	○	○	Blink
50 % of rated input ratio	○	Blink	○
75 % of rated input ratio	○	Blink	Blink
100 % of rated input ratio	Blink	○	○

6. Press the ENTER switch button (S132) and fix it.

	PEAK CUT		
	(L4)	(L5)	(L6)
0 % of rated input ratio	○	○	●
50 % of rated input ratio	○	●	○
75 % of rated input ratio	○	●	●
100 % of rated input ratio	●	○	○

7. To return to “Operating status display (Normal operation)”, press the EXIT switch button (S131).

**NOTE:** When pressed number is lost during setting, you must redo the setting procedure. Return to “Operation status display (Normal operation)” by pressing the EXIT switch button once, and restart from the beginning of the setting procedure.