

Assembly sliding system "MIRROR"

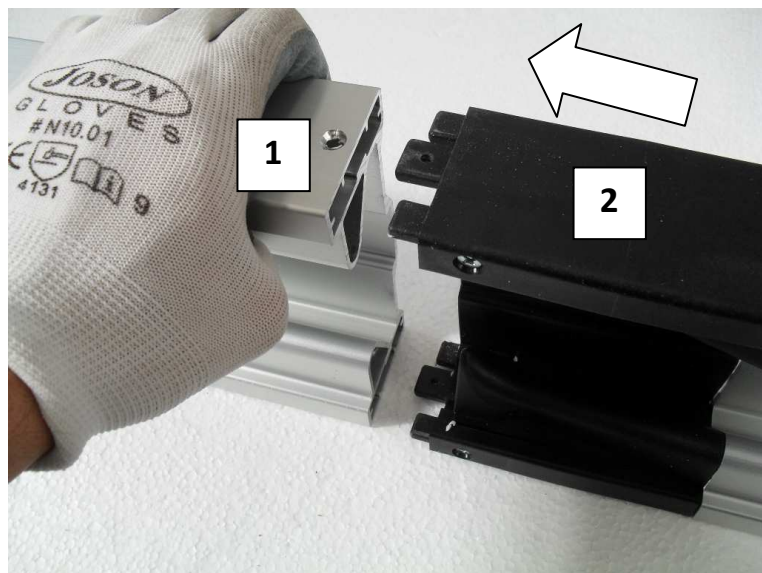

1) Remove screws from opening track.

2) Insert closure track (see photo).

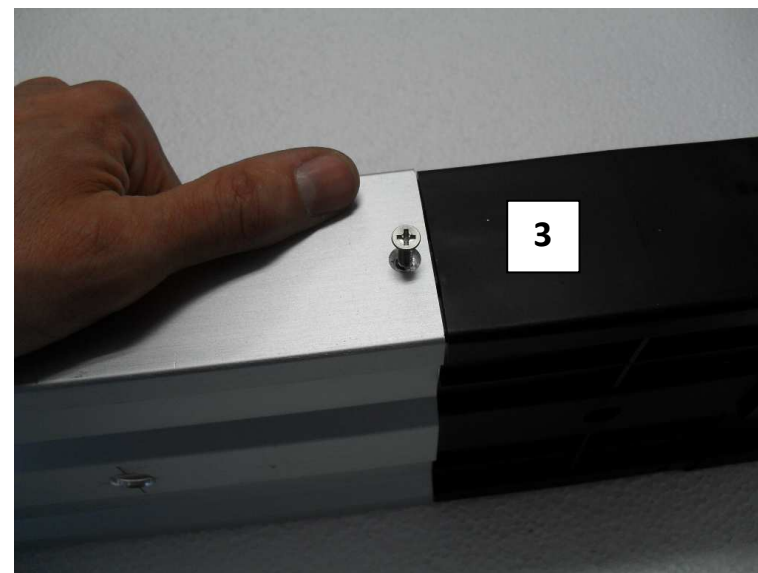

3) Fixing the tracks with the screws removed previously.

OPTIONAL Only for door with cover track

1) Remove the cover before installing the track.

2) Assembly and install the track.

3) Reassemble the cover where previously mounted.

Sliding doors hookup diagram

1

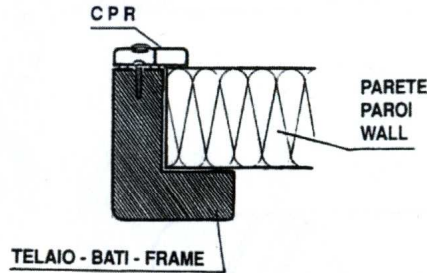

APPLICARE IL TELAILO DELLA PORTA PERFETTAMENTE VERTICALE SULLA PARETE E BLOCCARE AVVITANDO LA "CPR".
 APPLIQUER LE BATI DE LA PORTE PARFAITEMENT VERTICALE SUR LA PARETE ET BLOQUER EN VISSANT LA "CPR".
 MOUNT THE DOOR FRAME ON THE WALL IN A PERFECTLY VERTICAL POSITION AND FIX FIRMLY, TIGHTENING THE "CPR".

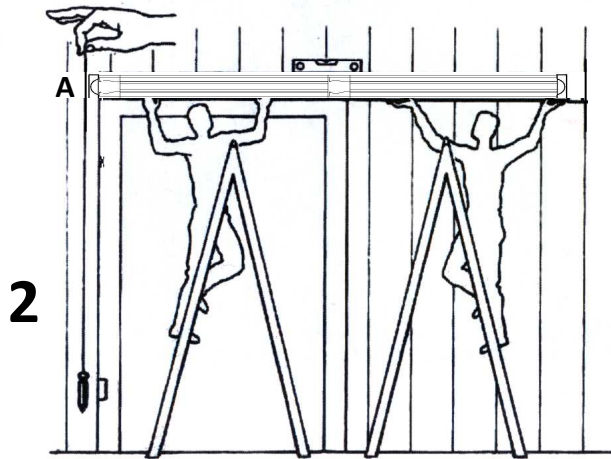

2

APPLICARE SUL TELAILO E CONTRO LA PARETE IL TRAVERSONE CON IL BINARIO PERFETTAMENTE ORIZZONTALE.
 APPLIQUER SUR LE BATI ET CONTRE LA PARETE LA TRAVERSE AVEC LE RAIL PARFAITEMENT HORIZONTAL.
 APPLY THE RAIL ON THE FRAME AND AGAINST THE WALL WITH THE RUNNER IN A PERFECTLY HORIZONTAL POSITION.

Posizione binario - Track position - Position du rail

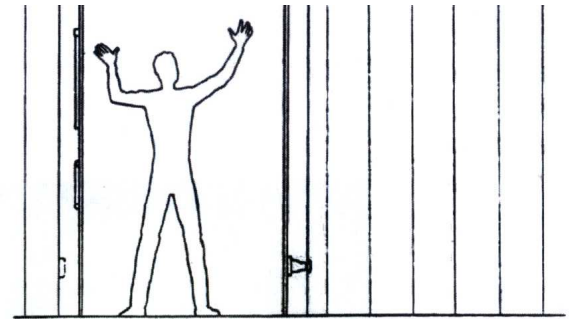
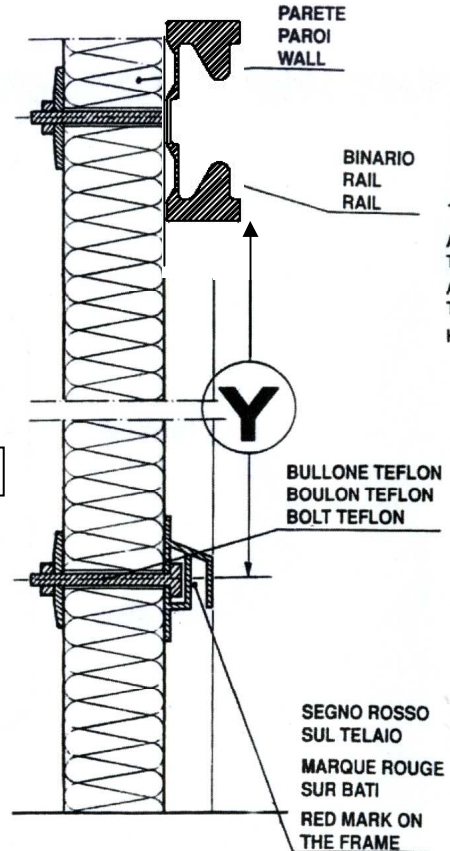
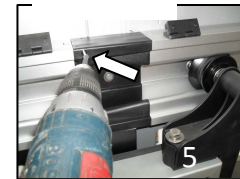
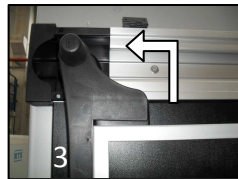
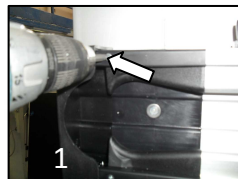
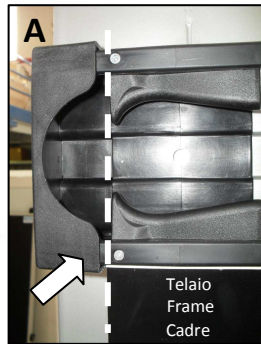

3

AGGANCIARE IL BATTENTE SCORREVOLE SUL BINARIO DEL TRAVERSONE.
 ACCROCHER LE BATTANT COULISSANT SUR LE RAIL DE LA TRAVERSE.
 HOOK THE SLIDING WING ON THE RUNNER RAIL.

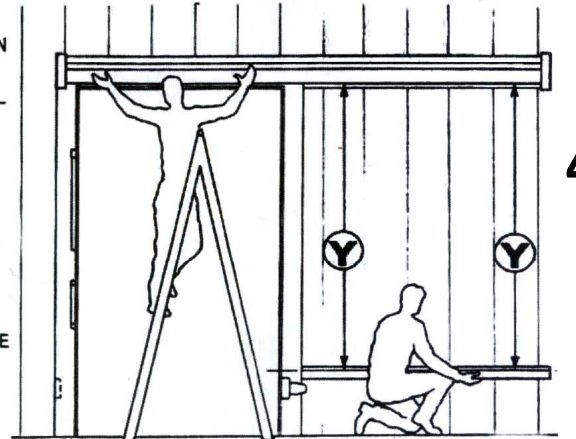

4

APPLICARE LA GUIDA POSTERIORE IN ALLUMINIO USANDO BULLONI, DADI, RONDELLONI IN TEFLON BIANCO. PER FARE I FORI DEI BULLONI IN TEFLON BISOGNA OSSERVARE SCRUPolosAMENTE LA QUOTA "Y". APPLI-

APPLIQUER LE COULISSEAU POSTERIEUR EN ALLUMINIO EN UTILISANT BOULONS, ECROUS ET RONDELLES EN TEFLON BLANC. POUR FAIRE LES TROUS DES BOULONS EN TEFLON. IL EST NECESSAIRE D'OBSERVER TRES ATTENTIVEMENT LA MESURE "Y". APPLIQUER LE CAISSON CACHE-RAILS

APPLY THE REAR GUIDE IN ALUMINIUM USING BOLTS, NUTS AND LARGE WASHERS IN WITHE TEFLON. WHEN MAKING HOLES IN THE TEFLON BOLIS IT IS ESSENTIAL TO SCRUPolosOUSLY RESPECT THE "Y" DIMENSION. APPLY